









Art.-Nr.: **94248/49**
(+MA 326) PJY 09/18

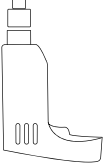

CE

 1x  3x  3x  1x  incl

  

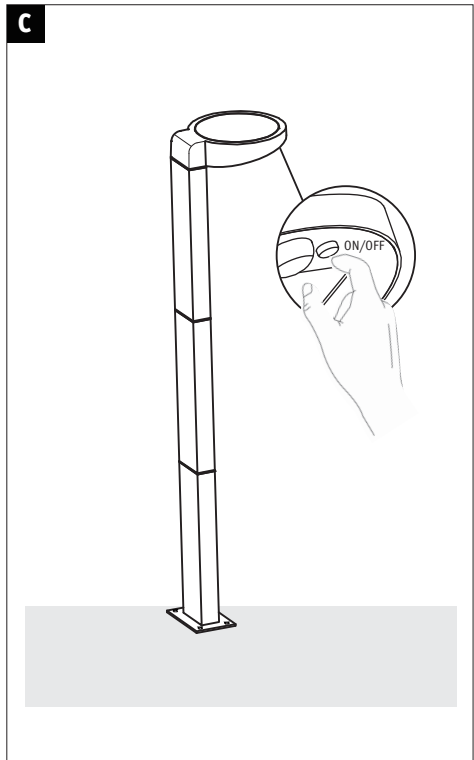
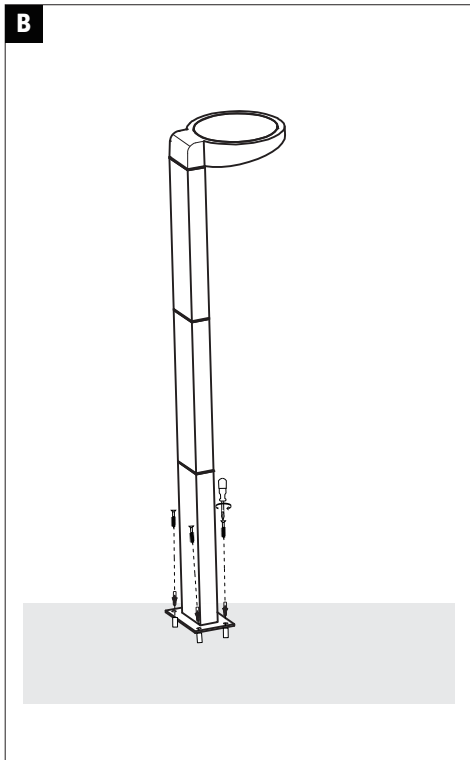
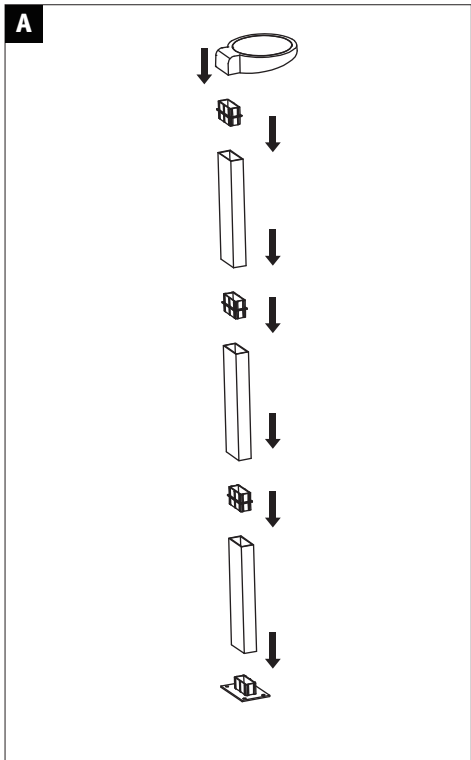





6-8H







 **T=4H**

IP44

