

GOODWE



User Manual

Hybrid Inverter

ET Series | ET Plus+ Series

V1.3-2022-07-20

TABLE OF CONTENTS

01 Product Introduction	1
1.1 Operation Modes Introduction.....	1
1.2 Safety and Warning.....	2
1.3 Product Overview	4
02 Installation Instructions	5
2.1 Unacceptable Installations.....	5
2.2 Packing List	6
2.3 Mounting.....	6
2.3.1 Select Mounting Location.....	6
2.3.2 Mounting	8
2.4 Electrical Wiring Connection	9
2.4.1 PE Cable Connection	9
2.4.2 PV Wiring Connection	10
2.4.3 Battery Wiring Connection	10
2.4.4 On-Grid&Back-up Connection.....	12
2.5 Communication Connections.....	16
2.5.1 Smart Meter & CT Description	16
2.5.2 BMS Connection.....	18
2.5.3 COM Terminal Connection.....	19
2.6 Earth Fault Alarm Connection.....	23
03 MANUAL OPERATION	27
3.1 Wi-Fi Configuration	27
3.2 PV Master	28
3.2.1 Commissioning via PV Master.....	28
3.2.2 Load Control.....	29
3.2.3 Battery Ready and Force Charge to Battery.....	32
3.3 CEI Auto-Test Function	33
3.4 Startup/shutdown Procedure	33
3.5 SEMS Portal	33

04 OTHERS.....	34
4.1 Error Messages.....	34
4.2 Troubleshooting.....	36
4.3 Disclaimer.....	40
4.4 Technical Parameters.....	42
4.5 Quick Checklist To Avoid Dangerous Conditions.....	54
Appendix.....	55

01 Product Introduction

The ET series and ET Plus series, also called hybrid or bidirectional solar inverters, provides energy management in a PV system that includes solar modules, a battery, loads, and utility grid connection. Energy produced by the PV system is prioritized to supply loads and then any excess energy to charge the battery. When the battery is fully charged, excess energy can be exported to the utility grid (if permitted). The inverter power rate limit (WGra) is not applicable to operate the mode of Changes in energy source operation.

The battery shall discharge to support loads when PV power is insufficient to meet self-consumption needs. If battery power is not sufficient, the system will take power from the utility grid to support loads.



The preceding introduction describes the general operation of the ET system. The operation mode can be changed with the PV Master app based on the system layout. The possible operation modes for the ET system are shown below.

1.1 Operation Modes Introduction

ET system normally has the following operation modes based on your configuration and layout conditions.

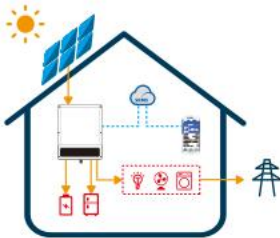

Mode I

The energy produced by the PV system is used to optimize self-consumption needs. The excess energy is used to recharge the batteries, any remaining excess is then exported to the grid.



Mode II

If the PV system is currently not generating any electricity and the battery is charged, loads are supplied with electricity from the battery and the grid.

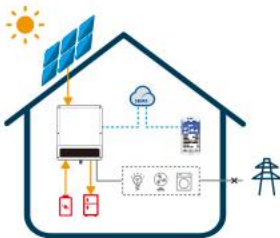

Mode III

(If backup function is included) When the grid fails, the system will automatically switch to back-up mode. The back-up loads can be supplied by both PV and battery energy.



Mode IV

Battery could be charged by grid, and charge time/power could be set to various options on the PV Master App.











1.2 Safety and Warning

The ET series and ET Plus series of inverters from GoodWe Technologies Co., Ltd. (also called GoodWe) strictly complies with related safety rules for product design and testing. Please read and follow all of the instructions and cautions appearing on the inverter or in the User Manual during installation, operation and maintenance, as any improper operation might cause personal injury or property damage.



These servicing instructions are for use by qualified personnel only. To reduce the risk of electric shock, do not perform any servicing other than that specified in the operating instructions. Ces instructions d'entretien sont destinées uniquement au personnel qualifié. Pour réduire le risque de choc électrique, n'effectuez aucun service autre que celui spécifié dans les instructions d'exploitation.

Symbol Explanation

	Caution! Failure to observe any warnings contained in this manual may result in injury.
	Danger - high voltage and electric shock!
	Danger - hot surface!
	The components of the product can be recycled.
	This side up! This package must always be transported, handled and stored in such a way that the arrows always point upwards.
	No more than six (6) identical packages being stacked on each other.
	Products shall not be disposed as household waste.
	Fragile - The package/product should be handled carefully and never be tipped over or slung.
	Refer to the operating instructions.
	Keep dry! The package/product must be protected from excessive humidity and must be stored under cover.
	This symbol indicates that you should wait at least 5mins after disconnecting the inverter from the utility grid and from the PV panel before touching any inner live parts.
	CE mark.

Safety Warnings

Any installation or operations on the inverter must be performed by qualified electricians in compliance with standards, wiring rules and the requirements of local grid authorities or companies (such as AS 4777 and AS/NZS 3000 in Australia).

Never insert or remove the AC or DC connections when the inverter is running.

Before making any wiring connections or performing electrical operations on the inverter, all DC and AC power must be disconnected from the inverter for at least 5 minutes to make sure that the inverter is totally isolated to avoid electric shock.

The temperature of the inverter surface can exceed 60°C during operation. Make sure it has cooled down before touching it and make sure the inverter is out of reach of children.

Do not open the inverter cover or change any components without manufacturer's authorization. Otherwise, the warranty for the inverter will be invalid.

The usage and operation of the inverter must follow the instructions in this User Manual. Otherwise, the protection design might be impaired and the warranty for the inverter will be invalid.

Appropriate methods must be adopted to protect the inverter from static electricity damage. Any damage caused by static electricity is not warranted by the manufacturer.

PV negative (PV-) and battery negative (BAT-) on inverter side are not grounded as the default design. Connecting either PV- or BAT- to EARTH is strictly forbidden.

Any PV modules used with the inverter must have an IEC61730 class A rating, and the total open-circuit voltage of the PV string/array must be lower than the maximum rated DC input voltage of the inverter. Any damage caused by PV overvoltage is not covered by the warranty.

When exposed to sunlight, the PV array generates dangerous high DC voltages. Please operate the inverter according to these instructions, or danger to life may result.

The inverter, with a built-in RCMU, will prevent the possibility of DC residual currents up to 6mA. Thus, in the system, an external RCD (type A) can be used ($\geq 30\text{mA}$).

In Australia, the output of the backup side in the switchbox should be labelled "Main Switch UPS Supply". The output on the normal load side in the switch box should be labelled "Main Switch Inverter Supply".

In Australia, the inverter internal switching does not maintain neutral integrity, which must be addressed by external connection arrangements like in the System connection diagrams.

1.3 Product Overview

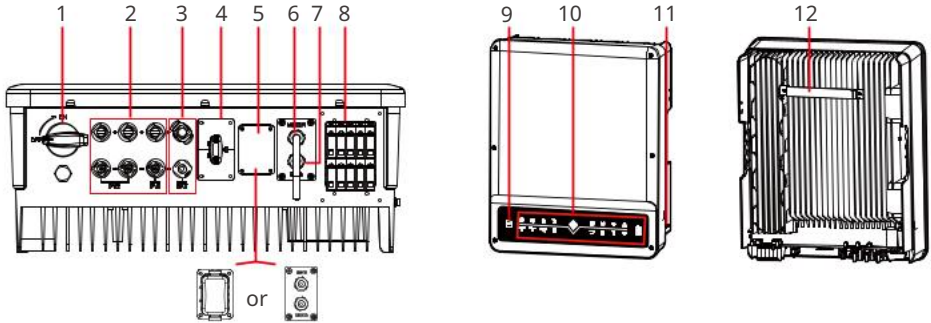

- | | | |
|--|---|---------------------------------|
| 1. DC Switch ^[1] | 2. PV Input Terminal (PV+/PV-) ^[2] | 3. Battery Terminal (BAT+/BAT-) |
| 4. Communication Module Port (WiFi or Bluetooth) | 5. COM Terminal | 6. METER Communication Port |
| 7. BMS Communication Port | 8. AC Terminal (ON-GRID and BACKUP) | 9. WiFi Reset |
| 10. Indicators | 11. PE Terminal | 12. Mounting Plate |













































[1] GW5KL-ET, GW6KL-ET, GW8KL-ET, GW10KL-ET: optional.

The DC switch of the inverters sold in Australia have to be installed by customers.

If the inverter is not equipped with a DC switch, an external DC breaker shall be added. The external DC breaker shall be AU/NZ certified; Complied to AS60947.3:2018; Be classified as DC-PV 2; With ratings and properties suitable for the intended application conditions such as outdoor, exposed to sunshine, on non-combustible material surface.

[2] GW8KL-ET and GW10KL-ET: 2 x PV+/PV-; 3 x PV+/PV- in Australia.

LED Indicators

INDICATOR	COLOR	STATUS	EXPLANATION
 SYSTEM			ON = System is ready
			BLINK = System is starting up
			OFF = System is not operating
 BACK-UP			ON = Back-up is ready / power available
			OFF = Back-up is off / on power available
 BATTERY			ON = Battery is charging
			BLINK 1 = Battery is discharging
			BLINK 2 = Battery is low / soc is low
			OFF = Battery is disconnected / not active
 GRID			ON = Grid is active and connected
			BLINK = Grid is active but not connected
			OFF = Grid is not active
 ENERGY			ON = Consuming energy from grid / buying
			BLINK 1 = Supplying energy to grid / zeroing
			BLINK 2 = Supplying energy to grid / selling
			OFF = Grid not connected or system not operating
 COM			ON = BMS and meter communication ok
			BLINK 1 = Meter communication ok, BMS communication fail
			BLINK 2 = BMS communication ok, meter communication fail
			OFF = BMS and meter communication fail
 WIFI			ON = WiFi connected / active
			BLINK 1 = WiFi system resetting
			BLINK 2 = WiFi not connect to router
			BLINK 4 = WiFi server problem
			OFF = WiFi not active
 FAULT			ON = Fault has occurred
			BLINK1 = Overload of back-up / Output / reduce load
			BLINK4 = CT wiring fault
			OFF = No fault

02 Installation Instructions

2.1 Unacceptable Installations

Please avoid the following installations which will damage the system or the Inverter. The following installations should be avoided. Any damage caused will not be covered by the warranty policy.

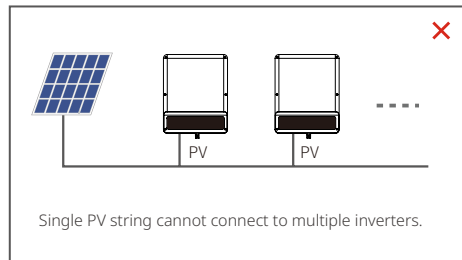
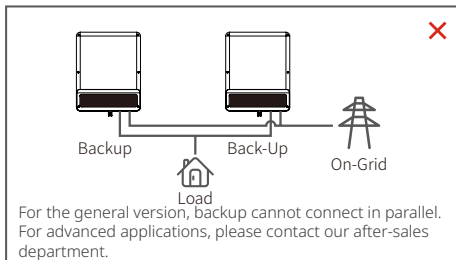

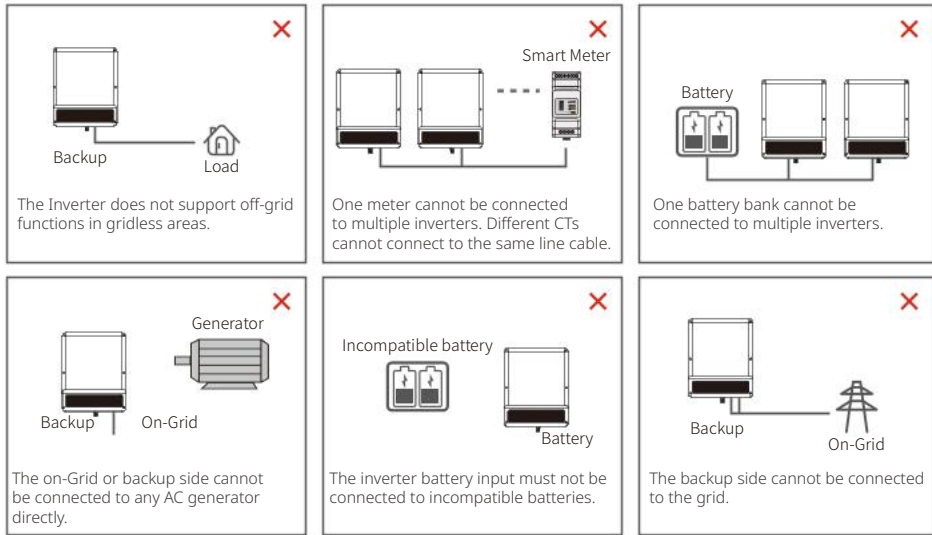

2.2 Packing List

Upon receiving the hybrid inverter, please check if any of the components as shown below are missing or broken.

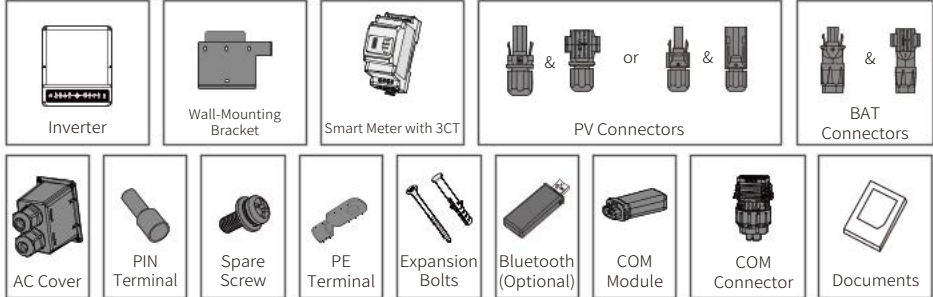

Note: The COM Connector is for ET Plus Series only. Make sure that the connector is installed correctly no matter you need the communication function or not.

2.3 Mounting

2.3.1 Select Mounting Location

For inverter's protection and convenient maintenance, mounting location for inverter should be selected carefully based on the following rules:

Rule 1. Any part of this system shouldn't block the switch and breaker from disconnecting the inverter from DC and AC power.

Rule 2. Inverter should be installed on a solid surface, where it is suitable for inverter's dimensions and weight.

Rule 3. Inverter should be installed vertically with a max rearward tilt of 15°.

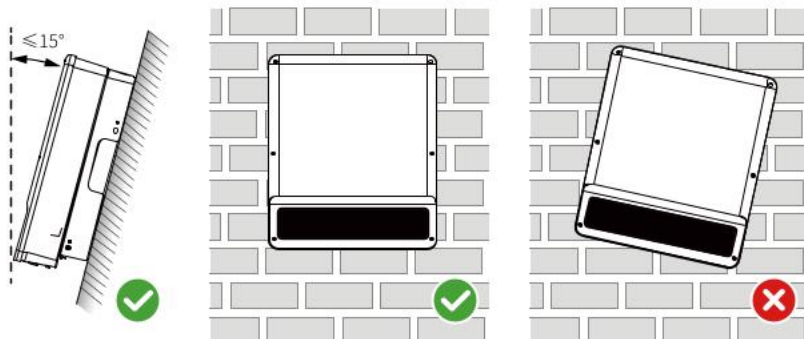

Rule 4. Ambient temperature should be lower than 45°C (113°F). High ambient temperature will cause power derating of inverter. The temperature and humidity at the installation site should be within the appropriate range (60 °C for outdoor unconditioned with solar effects).

Rule 5. It is recommended that the installation of the inverter should be prevented from direct sunlight, snow, rain and other negative influences which may cause function impact or life aging.

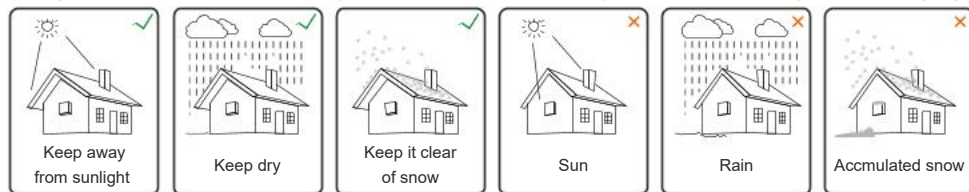

Rule 6. Inverter should be installed at eye level for convenient maintenance.

Rule 7. Product label on inverter should be clearly visible after installation. Do not damage the label.

Rule 8. Do not install the inverter when it is snowing or raining. If you have to, pay attention to the waterproof and moisture-proof of the inverter and distribution box.

Rule 9. Leave enough space around the inverter according to the below figure for natural heat dissipation.

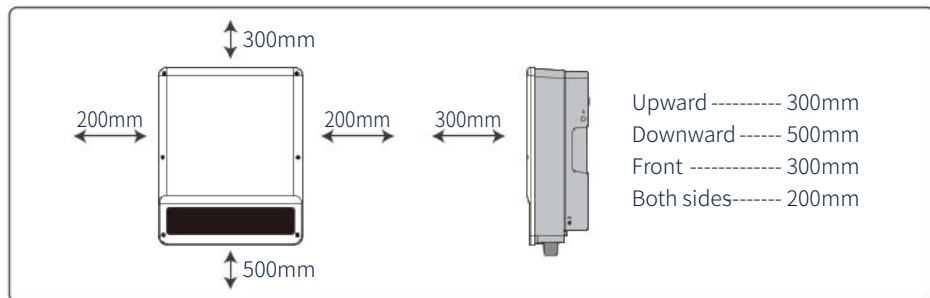

Install the inverter away from high magnetic field to avoid electromagnetic interference. If there is any radio or wireless communication equipment below 30MHz near the inverter, you have to:



1. Install the inverter at least 30m far away from the wireless equipment.
2. Add a low pass EMI filter or a multi winding ferrite core to the DC input cable or AC output cable of the inverter.

Mounting Support Requirements

- The mounting support shall be nonflammable and fireproof.
- Make sure that the support surface is solid enough to bear the product weight load.
- Do not install the product on the support with poor sound insulation to avoid the noise generated by the working product, which may annoy the residents nearby.

2.3.2 Mounting



The inverter must not be installed near flammable or explosive materials or near equipment with strong electromagnetism.

The inverter is suitable for mounting on concrete or other non-combustible surfaces only.

1

Please use the mounting bracket as a template to drill 4 holes in the correct positions (e.g. 10mm in diameter and 80mm in depth). Use the expansion bolts in the accessory box and tightly attach the mounting bracket to the wall.

Note: The bearing capacity of the wall must be greater than 25kg. Otherwise, the wall may not be able to prevent the inverter from dropping.

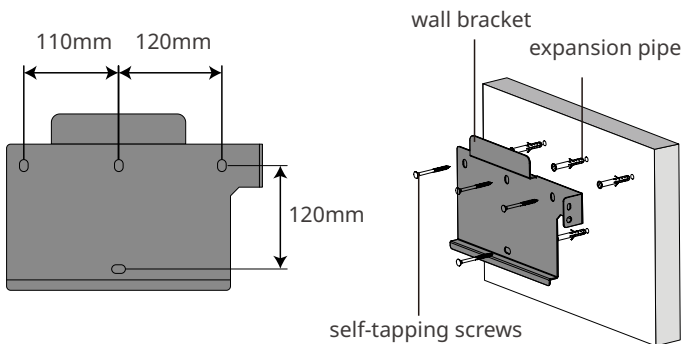

2

Carry the inverter by holding the heat sink on two sides and place the inverter on the mounting bracket.

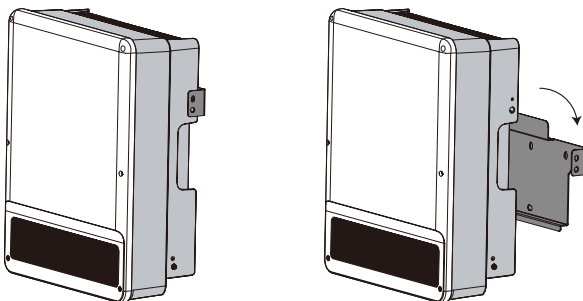

3

The inverters can be locked for anti-theft purposes if this is necessary for individual requirements.

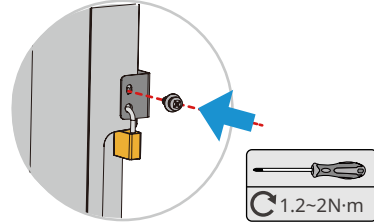
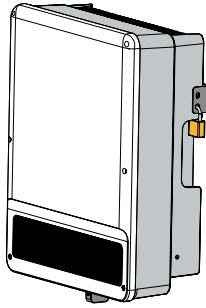

The lock is not included in the package and can be purchased by the user.

2.4 Electrical Wiring Connection

2.4.1 PE Cable Connection

1

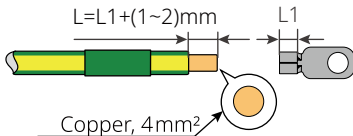

2

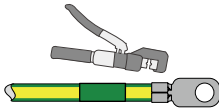

3

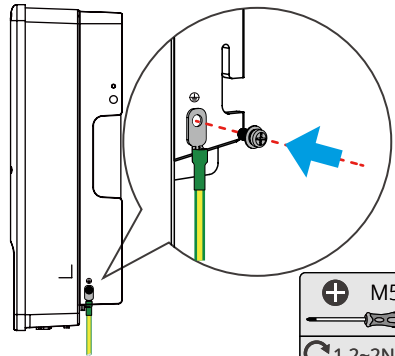
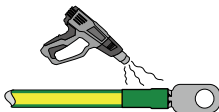

- Disconnect the PE cable after dismantling the equipment if needed.
- To improve the corrosion resistance of the terminal, it is recommended to apply silica gel or paint on the ground terminal after installing the PE cable.
- The PE cable should be prepared by customers. Recommended specifications:
 - Type: single-core outdoor copper cable.
 - Conductor cross-sectional area $S \geq 4\text{mm}^2$

2.4.2 PV Wiring Connection

Before connecting PV panels/strings to the inverter, please make sure all requirements listed below are followed:

- The total short-circuit current of a PV string must not exceed the inverter's max DC current. (For models GW8KL-ET and GW10KL-ET, PV2 has 2 pairs of PV connectors which can accept 2PV strings with a total short-circuit current of no more than 22A)
- The minimum impedance to earth of the PV module shall be greater than R. $R = \text{Max.Input Voltage (V)} / 30\text{mA}$, i.e. $R = 1100\text{V} / 30\text{mA} = 36.7\text{k}\Omega$ or $R = 1000\text{V} / 30\text{mA} = 33.4\text{k}\Omega$.
- The PV string must not be connected to the earth/grounding conductor.
- Use the right PV plugs in the accessory box. (BAT plugs are similar to PV plugs. Please check before using them.)

Note: There are MC4, QC4.10, or Amphenol plugs in the accessory box. The connection details are shown below.

1 Prepare the PV cables and PV plugs.

Note:
1. Please use the PV plugs and connectors from the accessory box.
2. The PV cable should be a standard 2.5–4mm².

2 Connect the PV cable to the PV connectors.

MC4 /QC4.10 Series AMPHENOL Series

Note:
1. Crimp the PV cable tightly onto the connectors.
2. For Amphenol connectors, the limit buckle cannot be pressed.
3. There will be a clicking sound if the connectors are inserted correctly into the PV plugs.

3 Screw the cap on and plug it into the inverter side.

Note: There will be a clicking sound if the connectors are inserted correctly into the PV plugs.

! The polarity of the PV strings must not be connected in a reverse manner. Otherwise, the inverter could be damaged.
For the GW8KL-ET and GW10KL-ET models, use two separate PV plugs if the short-circuit current of the PV array connected to inverter's PV2 input is greater than 15A.

2.4.3 Battery Wiring Connection

Please be careful of any electric shock or chemical hazards. For batteries without a built-in DC breaker, make sure that an external DC breaker ($\geq 40\text{A}$) connected. Make sure the battery is under normal working condition (such as battery voltage and BMS setting etc.) when the inverter and battery is to be used. If you need to use the hybrid inverter as a Grid-tied inverter, please contact GoodWe after-sales.



Make sure that the battery switch is off and that the nominal battery voltage meets ET series or ET Plus series specifications before connecting the battery to the inverter. Make sure the inverter is totally isolated from both PV and AC power. Please strictly follow the requirements and steps listed below. Using inappropriate wires may cause bad contacts and high impedances, which are dangerous for the system.

Use the correct BAT plugs from the accessory box.

The maximum battery current is 25A. Please use the tin-plated cables for which the cross section ranges from 4 to 6mm² (AWG 10). The battery cable requirements are shown in Figure 2.4.2-1.

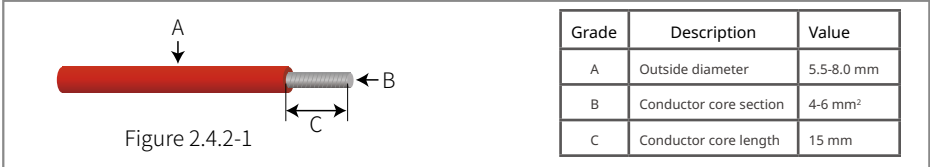
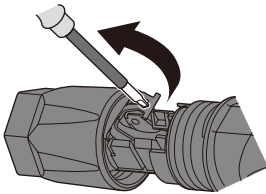

Figure 2.4.2-1

Battery wiring connection process

- 1 Open the spring using a screwdriver.



- 2 Carefully insert the stripped wire with twisted litz wires all the way into (A). The litz wire ends must be visible in the spring. Close the spring. Make sure that the spring is snapped into (B).

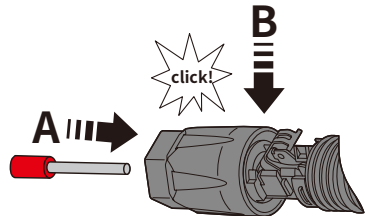

- 3 Insert the cable gland into the sleeve (C). Tighten the cable gland to 2 Nm torque (D). Use a suitable and calibrated torque wrench, size 15. Use an open-jaw wrench, size 16, to hold the connector in place.

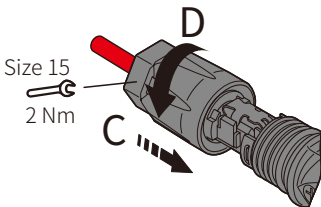

- 4 Insert two BAT connectors into the inverter BAT input. There will be a clicking sound if the connectors are inserted correctly.

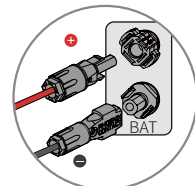

2.4.4 On-Grid&Back-up Connection

An external AC breaker is needed for on-grid connection to isolate the inverter from the utility grid when necessary.

Note: Backup function is optional for the German market, even though the hardware connector is always there. Backup function is standard in all other markets.

The requirements for the on-grid AC breaker are shown below.

Inverter Model	AC Breaker Specification
GW5K/GW5KL-ET	25A/400V (e.g. DZ47-60 C25)
GW6.5K/GW6KL-ET	25A/400V (e.g. DZ47-60 C25)
GW8K/GW8KL-ET	32A/400V (e.g. DZ47-60 C32)
GW10K/GW10KL-ET	32A/400V (e.g. DZ47-60 C32)

Note: The absence of AC breaker will lead to inverter damage if an electrical short circuit happens on grid side.

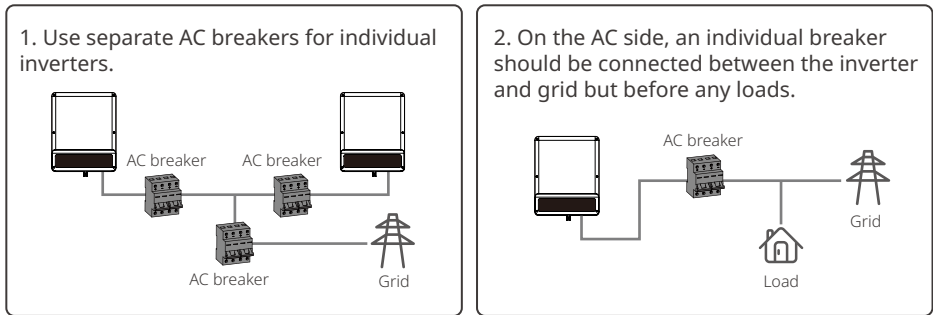

Notice

- Make sure the inverter is totally isolated from any DC or AC power before connecting the AC cable.
- For AC cables, the PE cable shall be longer than the N&L cables. This provides protection in case the AC cable slips or is removed, the ensuring that the earth conductor will be the last cable to take the strain.

Declarations for the backup function

The backup outputs of the inverters have overload capability.

For details please refer to the technical parameters.

The inverter has self-protection derating at high ambient temperatures.

The statement below lays out the general policies governing the series EH, EM, ES, ET, BH, BT and SBP energy storage inverters.

1. For hybrid inverters, a standard PV installation typically consists connecting the inverter to both panels and batteries. When the system is not connected to the batteries, the manufacturer strongly advises that the backup function not be used. The manufacturer will not honour the standard warranty and will not be liable for any consequences arising from users not following this instruction.

2. Under normal circumstances, the backup switching time is less than 10ms (e.g. the minimal condition to be considered as a UPS-level switching). However, some external factors may cause the system to fail in backup mode. Due to this, we recommend that users to be aware of these conditions and follow the instructions as described below:

- Do not connect loads which are dependent on a stable energy supply for reliable operation.
- Do not connect the loads which may, in total, exceed the maximum backup capacity.
- Try to avoid those loads which may create very high start-up current surges such as inverters, air conditioners, high-power pumps etc.
- Due to the battery condition itself, the battery current might be limited by factors including but not limited to temperature and weather etc.

Acceptable loads are shown below:

- Inductive Loads: 1.5 P non-frequency conversion air conditioners can be connected to the backup side. Two or more non-frequency conversion air conditioners connected to backup side may cause the back-up mode to be unstable.
- Capacitive Loads: A total power $\leq 0.6 \times$ nominal power of the model. (Any load with high startup current is not acceptable.)
- For complicated applications, please contact the GoodWe Solar Academy.

Note:

For convenient maintenance, please install a SP 3T switch on both the backup and on-grid sides. Then it is adjustable to support load by backup or by grid or default settings.

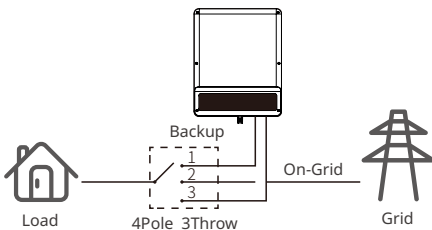

1. The backup load is supplied from backup side.
2. The backup load is isolated.
3. The backup load is supplied from grid side.

Declarations for backup overload protection

The inverter will restart itself if overload protection is triggered. The preparation time for restarting will be increasingly long (one hour at most) if an overload recurs. Take the following steps to immediately restart the inverter.

Decrease the backup load power to within the maximum limitation.

On The PV Master App > Advanced Settings > Click "Reset Backup Overload History".

Type One

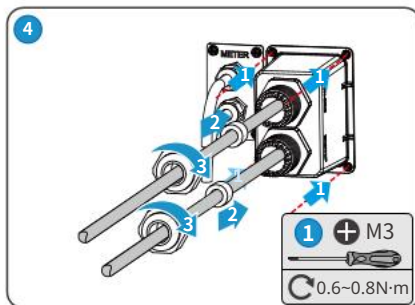
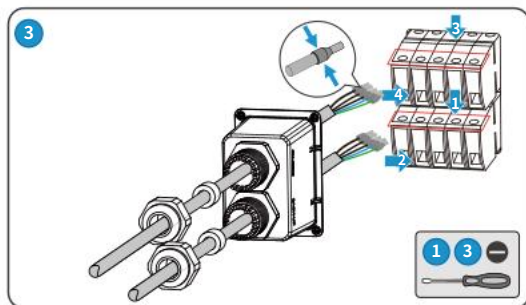
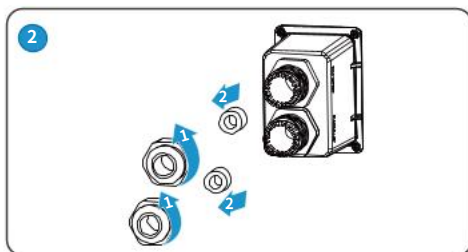
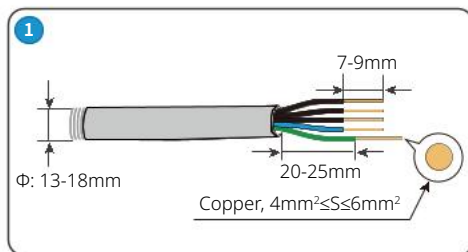
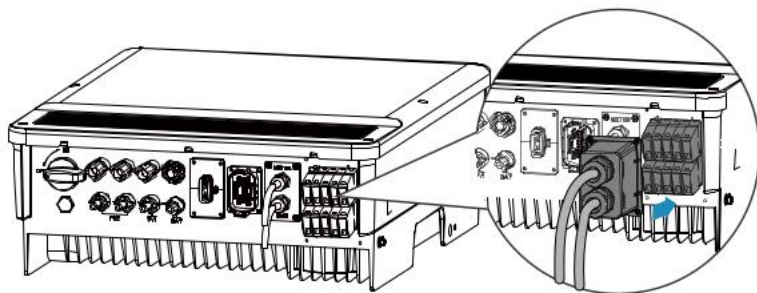

Type Two

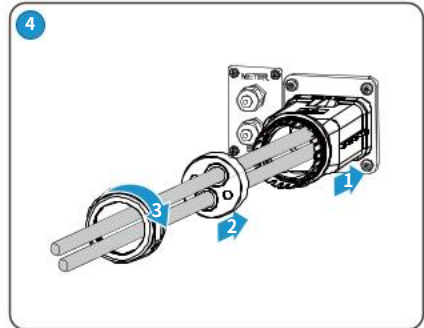
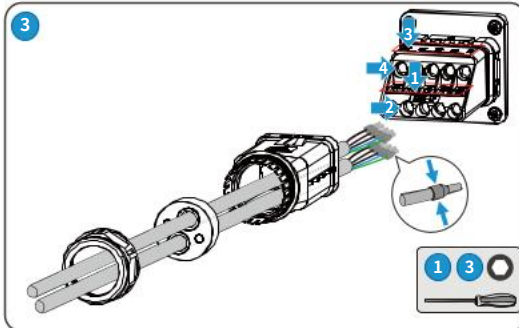
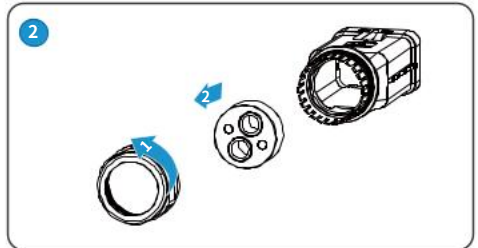
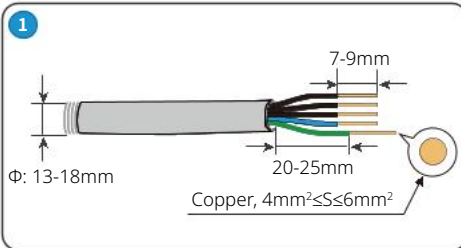
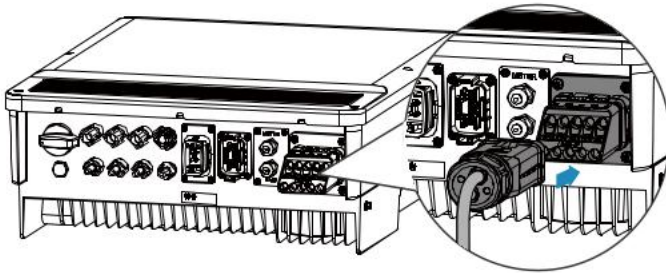

2.5 Communication Connections

2.5.1 Smart Meter & CT Description



Make sure the AC cable is totally isolated from AC power before connecting the Smart Meter and CT.

A Smart Meter with the CT in product box is compulsory for ET system installation. It can be used to detect the grid voltages and current directions, provide the operating condition of the ET inverter via RS485 communications, and limit the power exportation. GM3000 or SEC1000S are suggested. For more detailed information of the Smart Meter, refer to the Smart Meter user manual in <https://en.goodwe.com>.

Note:

1. The Smart Meter with CT is already configured ; please do not change any settings on the Smart Meter.
2. One Smart Meter can be used with only one ET inverter.
3. Three CTs must be used for one Smart Meter and must be connected on the same phase with the Smart Meter power cable.

Smart Meter & CT connection diagram

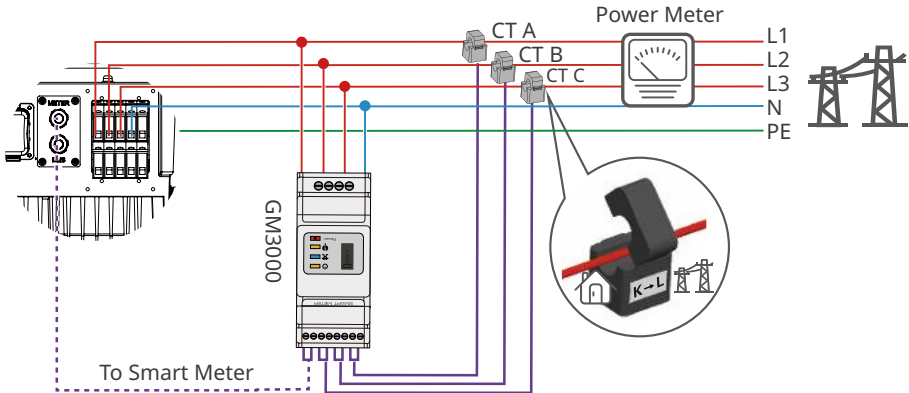

Note:

1. Please use the Smart Meter with the 3 CTs contained in the product box.
2. The CT cable is 3m long as a default and can be extended to maximum of 5m.
3. The Smart Meter communication cable (RJ45) is attached on the inverter ("To Smart Meter" cable), and be extended to a maximum length of 100m, and must use a standard RJ45 cable and plug, as shown below:

Type One

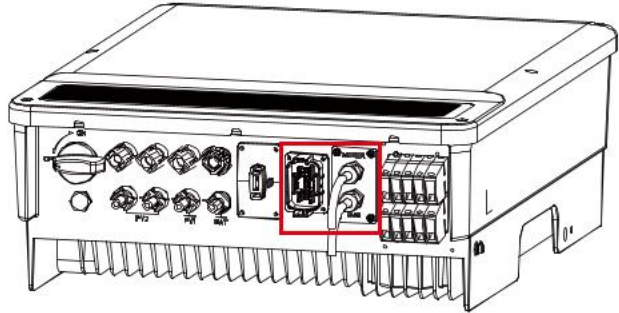
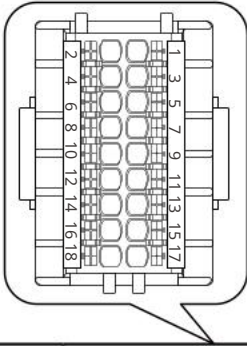

PIN	Definition	Function	PIN	Definition	Function
1	485_A1	RS485/EMS	9	Remote Shutdown	Remote Shutdown
2	485_B1		10	GND-S	
3	DRM 1/5 or DI_1	DRED or RCR	11	LG_EN+	LG Battery Enabling Signal
4	DRM 2/6 or DI_2		12	LG_EN-	
5	DRM 3/7 or DI_3		13/14	N/A	N/A
6	DRM 4/8 or DI_4		15/16		
7	COM/DRM0 or REF_1		17	DO-	Dry Contact of Load Control
8	REFGEN or REF_2		18	DO+	

No.	Color	BMS	Meter
1	Orange&White	485_A2	NC
2	Orange	NC	NC
3	Green&White	485_B2	485_B1
4	Blue	CAN_H	NC
5	Blue&White	CAN_L	NC
6	Green	NC	485_A1
7	Brown&White	NC	485_B1
8	Brown	NC	485_A1

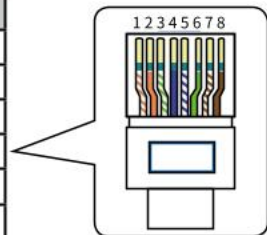

BMS: CAN communication is configured by default. If 485 communication is used, please contact the after-sales service to replace this with the correct communication cable.

2.5.2 BMS Connection

BMS is used to communicate with the connected compatible lithium battery. There is a 3m communication cable marked "To Battery" on the inverter except ETR models. For ETR models, the net cable should be prepared by the customer and should be no longer than 5m.

Connection steps

1. Confirm that the battery and inverter power cables are connected (refer to 2.4.2 Battery Wiring Connections).
2. Connect the BMS communication cable of the inverter to the communication interface of the lithium battery.
3. Select the corresponding battery via the APP (please refer to the user manual of the PV master app).

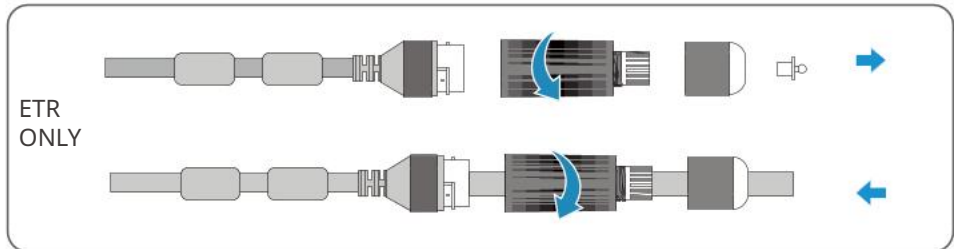
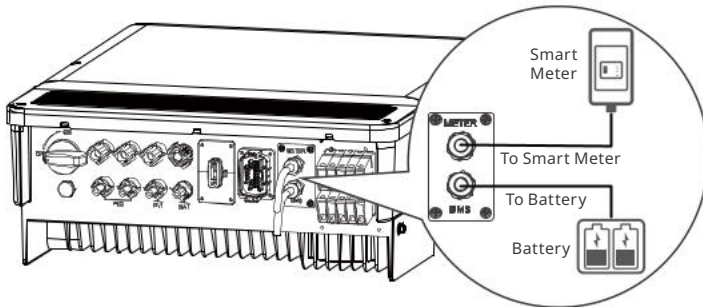

2.5.3 COM Terminal Connection

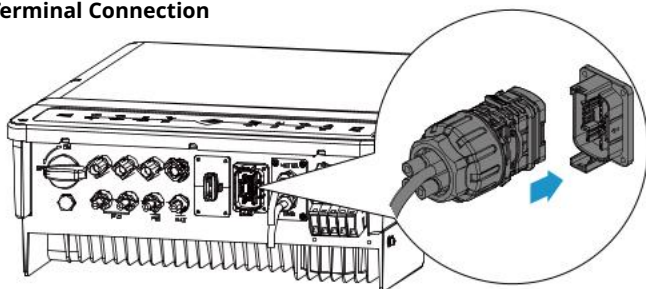

Follow the pin definition below to connect the communication cables. Do not remove the resistor or short circuit wire unless you are going to use the corresponding PINs.

For GW5K-ET, GW6.5K-ET, GW8K-ET, GW10K-ET, GW5KL-ET, GW6KL-ET, GW8KL-ET, GW10KL-ET, assemble the communication module and plug it into the communication terminal directly if you are not going to use the communication functions.

1

Prepare the communication cable and remove the plug of the communication terminal.

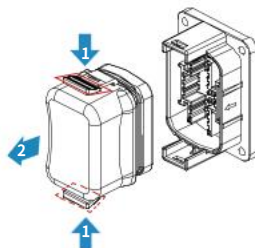
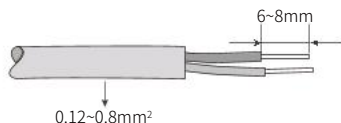

2

Dismantle the communication module and take out the pin terminal. To avoid water and dust, keep the rubber plug to seal the unused holes.

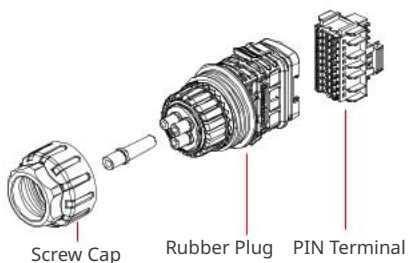

3-1

Insert the communication cable into pin 1 and pin 2 of the pin terminal to realize the RS485 communication function.

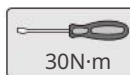
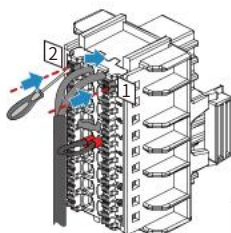

3-2

Remove the resistor, then insert the communication cable into pin 3, 4, 5, 6, 7, and 8 to realize the DRED or RCR function. Keep the resistor by default if DRED or RCR function is not to be used.

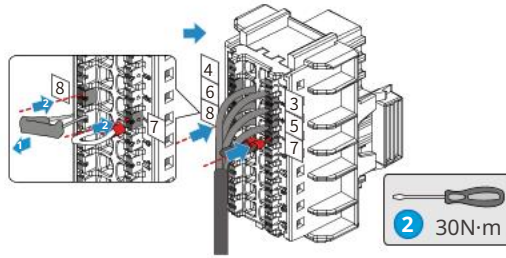

(PIN 7 REF_1)

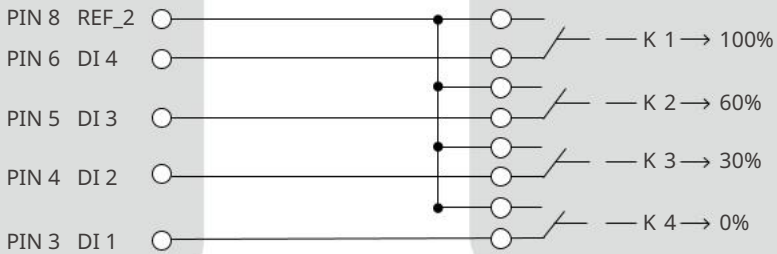

Inverter

RCR

3-3

Remove the short circuit wire. Connect pin 9 and pin 10 with an external switch using a communication cable. Keep the short circuit wire by default if remote shutdown function is not to be used.

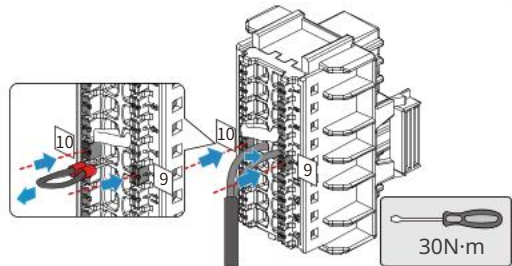

3-4

Insert the communication cable into pin 11 and pin 12 to realize the battery enabling signal function. Designed for LG battery only.

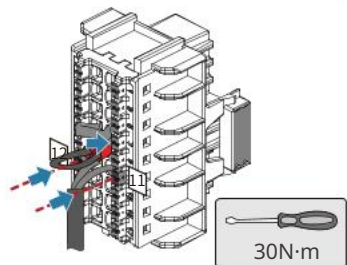

3-5

Insert the communication cable into pin 17 and pin 18 to realize the dry contact relay function.

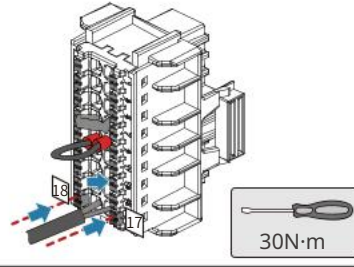

4

Assemble the communication module and plug it into the communication terminal.

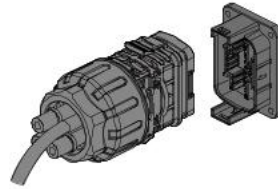

Type Two

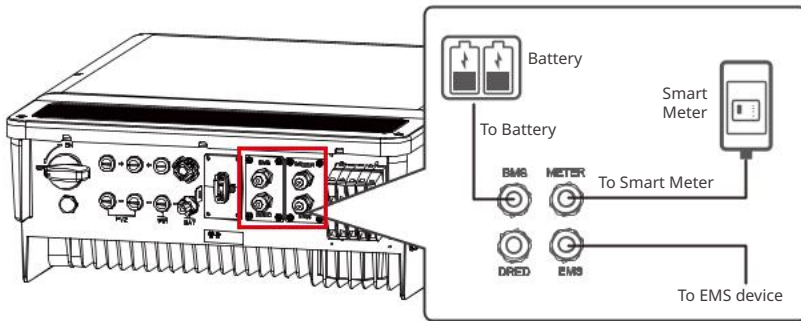

No.	Color	BMS	Meter	EMS
1	Orange&White	485_A2	NC	485_A
2	Orange	NC	NC	485_B
3	Green&White	485_B2	485_B1	485_A
4	Blue	CAN_H	NC	NC
5	Blue&White	CAN_L	NC	NC
6	Green	NC	485_A1	485_B
7	Brown&White	NC	485_B1	NC
8	Brown	NC	485_A1	NC

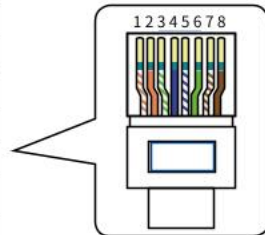

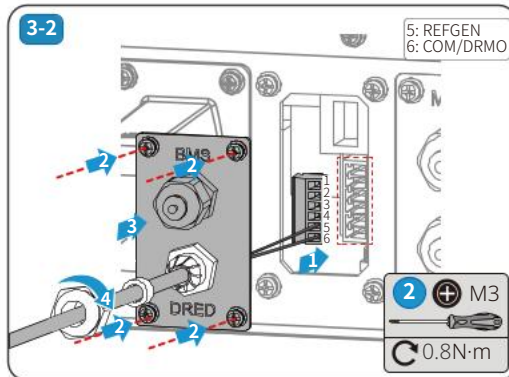
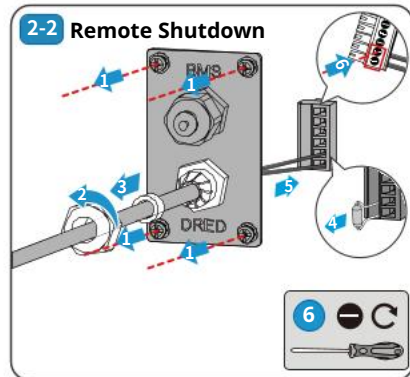
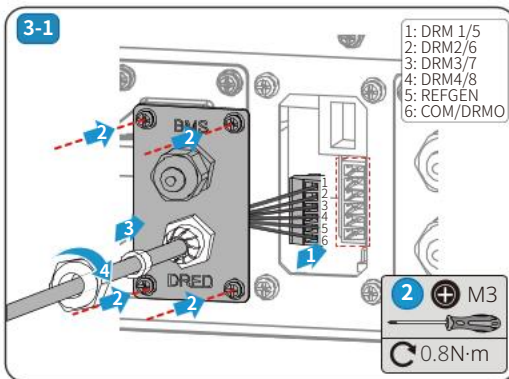
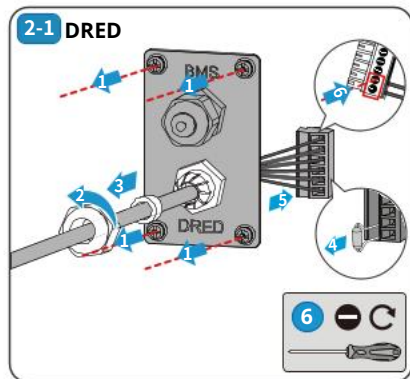
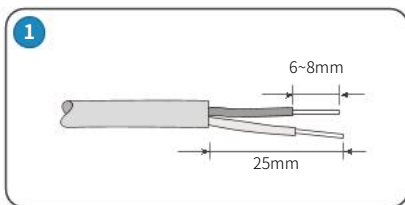
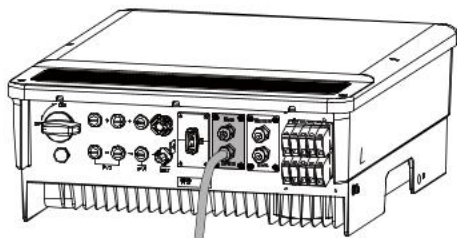

Notice

- Enable DRED function or Remote Shutdown function via PV Master app. Read section 3.2 PV Master to get more information.
- The 6-pin terminal in the inverter has the same function of DRED device. Please leave it in the inverter if no external device connected.

4

Connect the terminal to the right position onto the inverter.

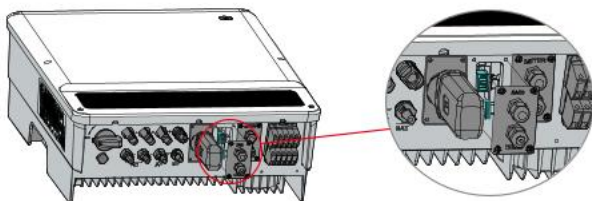

2.6 Earth Fault Alarm Connection

ET series and ET Plus series inverters comply with IEC 62109-2 13.9. The fault indicator LED on the inverter cover will light up and the system will email the fault information to customer. It must be installed in a high traffic area where the LED would be noticed

Wiring system for the ET series and ET Plus series hybrid inverter

Note: This diagram indicates the wiring structure of the ET series and ET Plus series hybrid inverter, not the electric wiring standard.

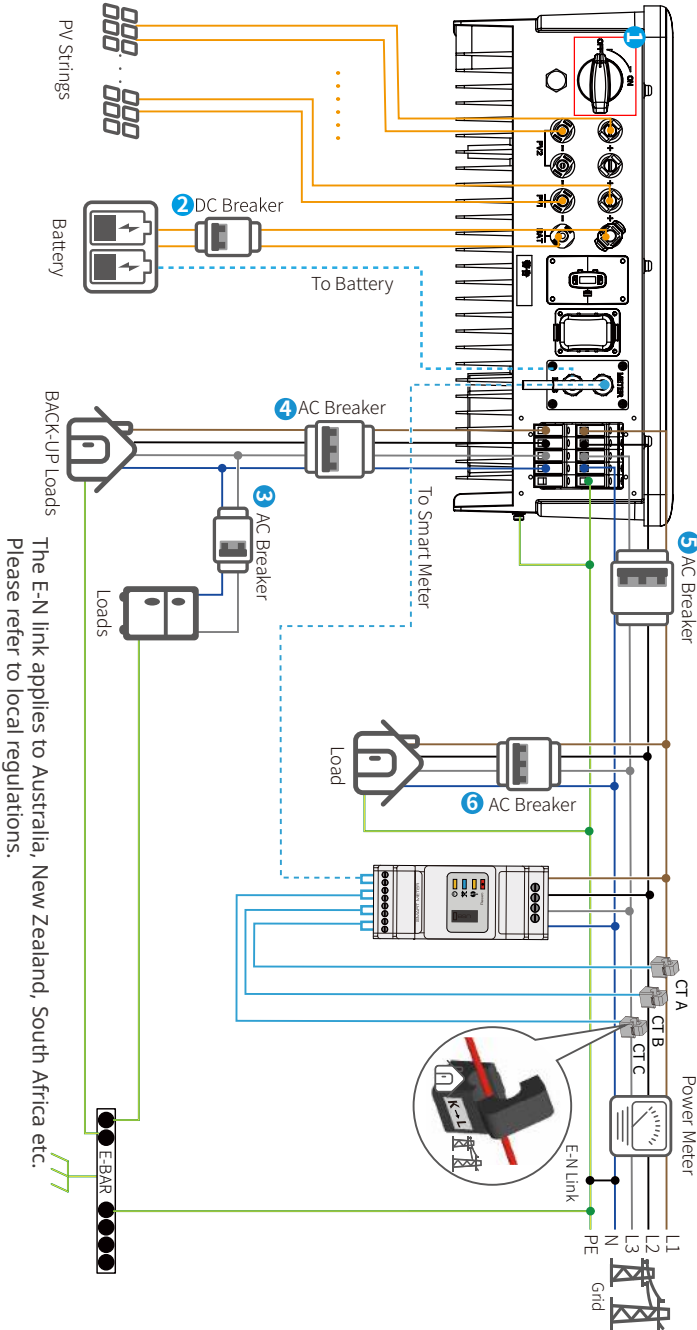

Please select the breaker according to the specifications below:

Inverter	①	②	③	④	⑤
GW5KU/6KL-ET		25 A/400 V AC breaker			Depends on household loads
GW8KU/10KL-ET		32 A/400 V AC breaker			
GW5K/6_5K-ET		25 A/400 V AC breaker			
GW8K/10K-ET		32 A/400 V AC breaker			
GW5KN/6_5KN-ET		25 A/400 V AC breaker			
GW8KN/10KN-ET		32 A/400 V AC breaker			

1. For batteries with attached breakers, the external DC breaker may be omitted.
2. Please use CT A for L1, CT B for L2, and CT C for L3. Also, follow the "House(K) → Grid(L)" direction to complete the connection. Otherwise, there will be an error reminder from the PV Master App.

BACK-UP Loads
The E-N link applies to Australia, New Zealand, South Africa etc.
Please refer to local regulations.

If the inverter is not equipped with a DC switch, an external DC breaker shall be added. The external DC breaker shall be AU/NZ certified; Complied to AS60947.3:2018; Be classified as DC-PV 2; With ratings and properties suitable for the intended application conditions such as outdoor, exposed to sunshine, on non-combustible material surface.

System connection diagrams

Note: According to Australian safety requirements, the neutral cables of the on-grid side and backup side must be connected together at the neutral bar. Otherwise, the backup function will not work.

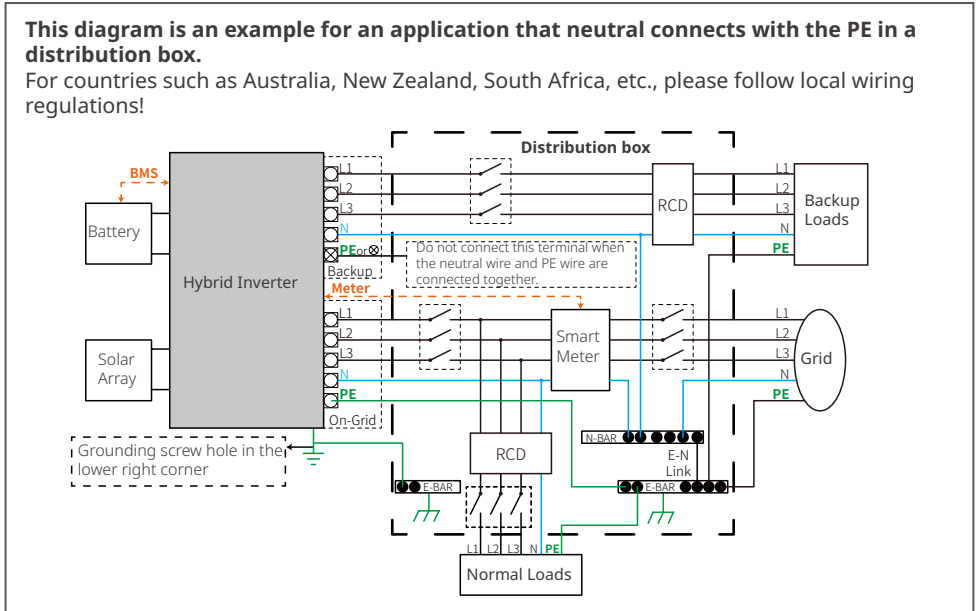

When the inverter is working in backup mode, neutral and PE on the backup side are connected via the internal relay. Also, this internal relay will be open when the inverter is working in grid-tied mode.

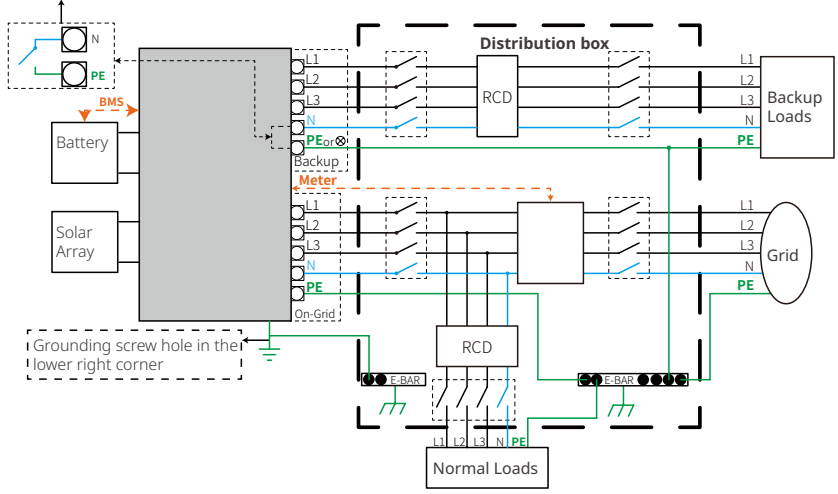

03 MANUAL OPERATION

3.1 Wi-Fi Configuration

This part shows the configuration using a web page.

Wi-Fi configuration is absolutely necessary for online monitoring and maintenance.

Preparation:

1. The inverter must be powered up with battery or grid power.
2. A router with internet access to the website www.semsportal.com is required.

1

1. Connect Solar-Wi-Fi* to your PC or smart phone (* its name is the last 8 characters of the inverter's serial number); Password:12345678.
2. Open your browser and logon to 10.10.100.253 Admin (User): admin; Password: admin.
3. Then click "OK".

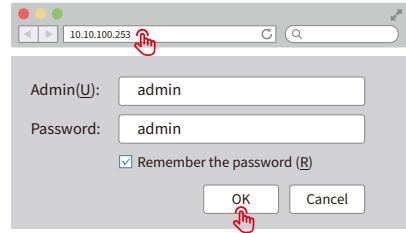

2

1. Click "Start Setup" to choose your router.
2. Then click "Next".

Device information

Firmware version	1.6.9.3.38.2.1.38
MAC address	60:C5:A8:60:33:E1
Wireless AP mode	Enable
SSID	Solar-Wi-Fi
IP address	10.10.100.253
Wireless STA mode	Disable
Router SSID	WiFi_Bum-in
Encryption method	WAP/WAP2-PSK
Encryption algorithm	AES
Router Password	WiFi_Bum-in

A "cannot join the network" error may be caused by:

No router, weak Wi-Fi signal, or the password is not correct

★ **Help:** The wizard will help you to complete setup within one minute.

Start Setup 

Please select your current wireless network

SSID	AUTH/ENCRY	RSSI	Channel
<input type="radio"/> Wi-Fi_Burn-in	WPAPSKWPA2PSK/TKIPAES	66	1
<input type="radio"/> Wi-Fi_Burn-in	WPAPSKWPA2PSK/TKIPAES	100	1
<input type="radio"/> Wi-Fi_Burn-in	WPAPSKWPA2PSK/TKIPAES	70	1
<input type="radio"/> Wi-Fi_Burn-in2	WPAPSKWPA2PSK/TKIPAES	72	1

Refresh

★ **Help:** When the RSSI of the selected Wi-Fi network is below 15%, the connection may be unstable. Please select another available network or decrease the distance between the device and router. If your wireless router does not broadcast its SSID, please click "Next" and manually add the wireless network.

Back Next 

3

1. Fill in the password of the router, then click "Next".
2. Click "Complete".

Add the wireless network manually

Network name (SSID)
 Encryption method
 Encryption algorithm

Please enter the wireless network password:

Password (8-63 characters)

Note: The SSID and password are case sensitive. Please make sure all parameters of the wireless network match those of the router, including the password.

Back Next 

Save success!

Click "Complete". the current configuration will take effect after a restart.

If you still need to configure the other pages of information, please proceed to complete your required configuration.

The configuration is complete. You can now log on to the Management page to restart the device by clicking on the "OK" button.

Click Confirm to complete?

Back Complete 

Note:

1. Please make sure the password and encryption method/algorithm are the same as those of the router.
2. If everything went well, the WiFi indicator on the inverter will change from a double blink to 4 blink and then to a steady status, which means that the WiFi has successfully connected to the server.

WiFi Reset & Reload

WiFi reset means restarting the WiFi module. The WiFi settings will automatically be reprocessed and saved. WiFi Reload means setting the WiFi module to the default factory settings.

WiFi Reset Button



WiFi reset

Short press the reset button.
The WiFi LED will blink for a few seconds.

WiFi reload

Long press the reset button more than 3s.
The WiFi indicator will double blink until the WiFi is configured again.

Note:

The WiFi reset and reload function can be used only when:

1. WiFi disconnects with the internet or cannot connect successfully to the PV Master App.
2. "Solar-WiFi signal" cannot be found or other WiFi configuration problems exist.

Do not press the button if WiFi monitoring is working correctly.

Replace the module using the unlock tool.

3.2 PV Master

PV Master is an external monitoring and configuration application for hybrid inverters and is used on smart phones or tablets for both Android and iOS systems. The main functions are listed as below:

1. Configure the system to customize functions by the user.
2. Monitor and check the performance of the hybrid system.
3. Access and change the regional settings.
4. Check the inverter firmware version.
5. Set export power limit.

Search PV Master in Google Play or Apple App Store, or scan the QR code to download the app.

Operation steps are the same for Android system and iOS system although the two interfaces are slightly different.

For more detailed operation instructions, please refer to PV Master user manual in www.goodwe.com.



PV Master App

Note:

For Australian customers please select from Australia Region A/B/C to comply with AS/NZS 4777.2:2020. Contact local grid operator to see which Region to select. After setting the safety region, some parameters in the inverter system will take effect according to the corresponding safety regulations, such as PU curve, QU curve, trip protection, etc. For Australian and European users, if you need to change the configuration parameters, please refer to the PV Master user manual.

3.2.1 Commissioning via PV Master

Log in using the initial password for the first time and change the password as soon as possible. To ensure account security, you are advised to change the password periodically and keep the new password in mind.

Steps to connect the WiFi:

Step 1: PV Master →Connect Device→Inverter with WiFi

Step 2: Phone Settings→WLAN→Solar-WiFi*****

Step 3: PV Master→Solar-WiFi****

Follow the steps below to set basic settings.

PV Master→Settings→Basic Setting→Installer Password(goodwe2010)→Select Safety→Select Work Mode→CT Detection

3.2.2 Load Control

The inverter is equipped with a dry contact relay, which helps turn the loads on or off when an extra contactor is connected.

Note:

- The AC contactor should be placed between the inverter and the loads. Do not connect the load to DO port directly.
- The contactor is not supplied by the manufacturer. Connect the the load to the DO port of the inverter directly if the load is designed with a DI port.
- Maximum voltage and current at DO dry contact port: 250VAC 3A/30VDC 3A.
- When the controlled load is connected to ONGRID, the contactor coil must also be connected to ONGRID. When the controlled load is connected to BACKUP, the contactor coil must also be connected to BACKUP.

Tap **Settings**→**Load Control** to enter load control page and select the working mode.

Working mode: Power Switch Mode, Time Mode and Backup Load Control Mode.

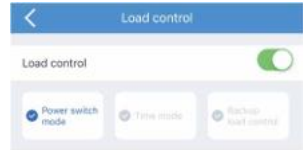

Power Switch Mode

Turn on or off the loads via PV Master app directly.

- Select **Power Switch Mode** and tap **ON**. Once the inverter receives **ON** command, the contactor will be connected and loads be powered on.

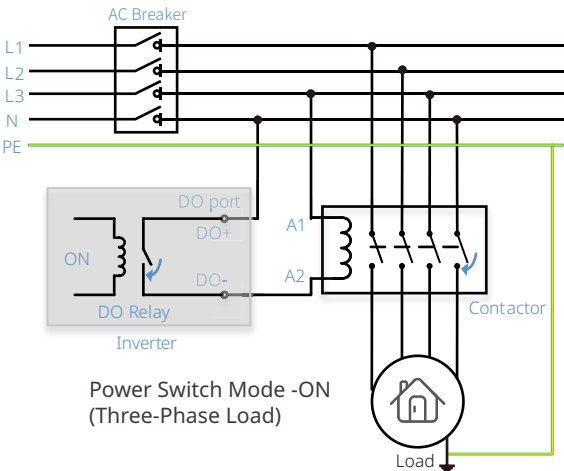

Power Switch Mode -ON
(Three-Phase Load)

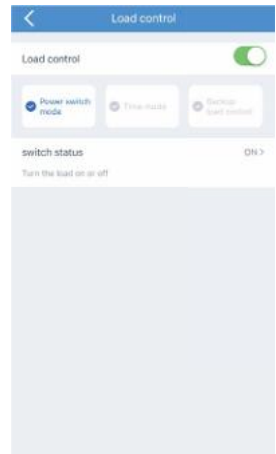

- Select **Power Switch Mode** and tap **OFF**. Once the inverter receives **OFF** command, the contactor will be disconnected and loads be powered off.

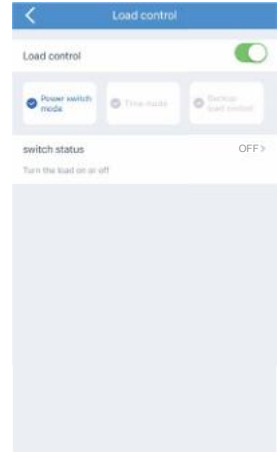
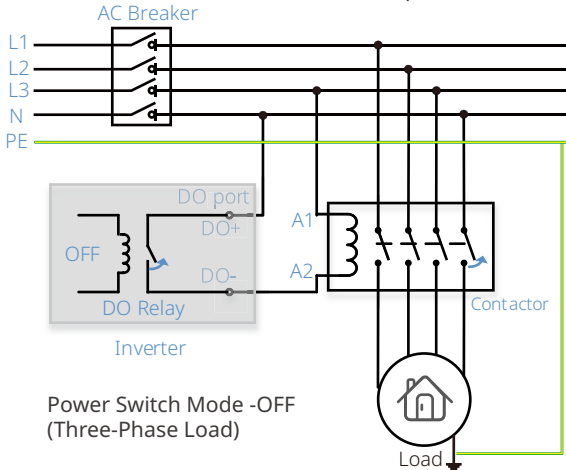

Time Mode

Standard Time Mode: Set the starting time and end time to turn on the loads at the preset time only. The loads will not work except the preset period.

Select **Time Mode**→**Add**→**Standard**→**Turn on time&End time&Repeat**→**Save** to set the turn on time, end time and repeat day.

The following figures show the example to turn on the load from 8:00 a.m. to 9:00 a.m.

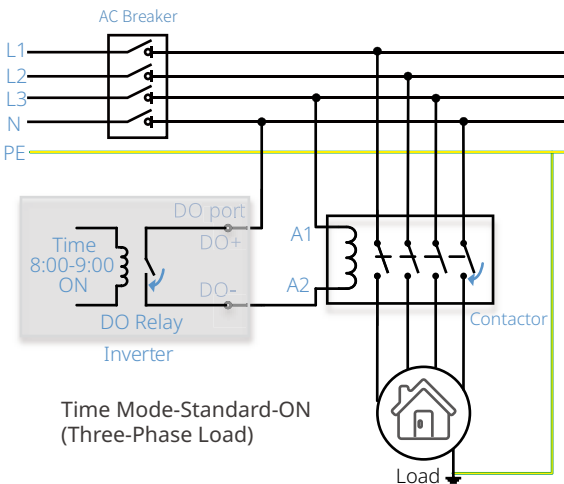

Intelligent Time Mode: set time range, load consumption time, and nominal power of load via PV Master. Once the excess energy of the photovoltaic exceeds the preset load nominal power, the loads will be turned on.

Note:

- The intelligent mode cannot be set when the inverter is working in off-grid mode.
- Switch off Export Power Limit before setting intelligent mode.
- Load consumption time means the shortest load working time after the loads been turned on. The time is set to prevent the loads be turned on and off frequently when the PV power fluctuates greatly.

Set load consumption time to 30 minutes means the loads will work for at least 30 minutes even when the excess PV power is lower than 1000W.

Select **Time Mode**→**Add**→**Intelligent**→**Turn on time&End time&Repeat&Load consumption time&Nominal power of load**→**Save** to set the turn on time, end time, repeat day, shortest working time and nominal power.

The following figures show the example to power on the loads from 8:00 a.m. to 9:00 a.m., when the excess PV power exceeds 1000W.

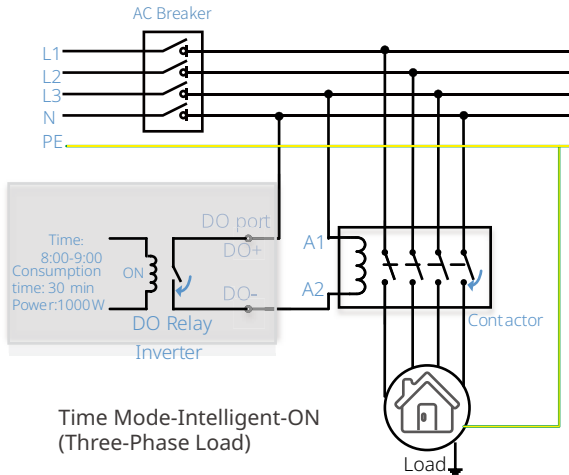

Time mode

Selection mode:
Standard

The load will turn on within the set time

Intelligent

In the set time range, when the excess energy of the photovoltaic exceeds the set rated power of the load, the load will be turned on.

Turn on time 08:00

End Time 09:00

repeat Never

Load consumption time 30 Min

The shortest running time after the load is turned on, input range: (15, 1440)min

Nominal power of load kW

When the excess photovoltaic energy exceeds the rated power of the load, the load will turn on.

BACKUP Load Control

Some unimportant loads connected to the BACKUP terminal do not need to be powered all the time. If the PV system is not generating any electricity and the grid is not working, the unimportant loads can be disconnected, so that the battery energy can be supplied to other important loads in priority.

Set the SOC value via PV Master. When the battery SOC is lower than the target SOC value, the inverter can disconnect the loads through the DO port. The SOC threshold for the load to turn on again is 10%.

For example, set the SOC value to 60%. The loads will be disconnected when the SOC of the battery is below 60%. To turn on the loads again, the SOC of the battery should be restored to 70%.

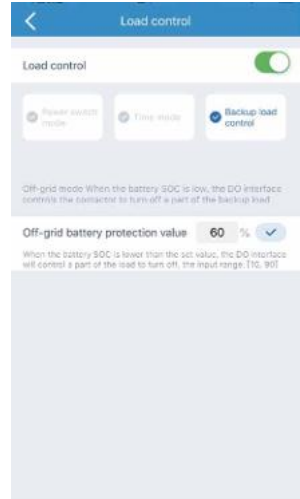
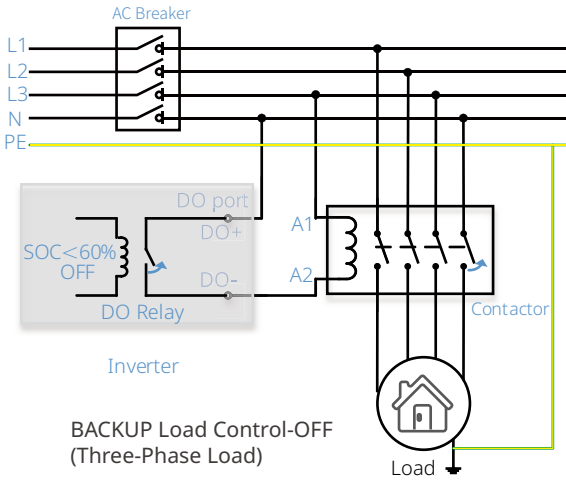

3.2.3 Battery Ready and Force Charge to Battery

Battery Ready(ETR)

Battery Ready function is a fee-based function, which is off by default. Contact the after-sales service to pay for the function and obtain the series number. The after-sales service staff will activate the battery-ready function. Connect the inverter to PV Master again after receiving an activation notification from the after-sales service staff.

Tap Advanced Setting→Battery Setting to check the battery status.

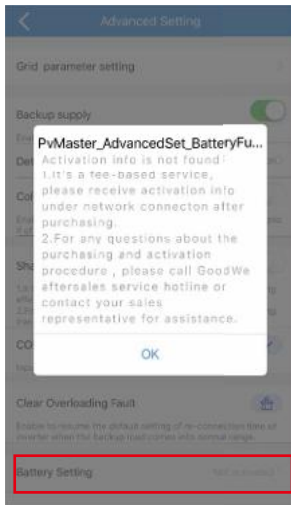

Battery ready not activated



Battery ready activated

Force Charge to Battery

Tap **Advanced Setting**→**Battery Setting** →**Force Charge to Battery**→**SOC(discontinue)**→**Save** to set the SOC and start force charge to battery function.

After starting the force battery to charge function, the power of the system gives priority to charging the battery until the preset SOC is reached.

3.3 CEI Auto-Test Function

The PV auto-test function of CEI is integrated into the PV Master App to satisfy Italian safety requirements. For detailed instructions regarding this function, please refer to "PV Master Operation Instructions".

3.4 Startup/shutdown Procedure

DC switch is used to cut off PV input power while the breaker equipped on the battery is used to cut off battery power.

When you want to shut down the inverter during an event, you shall turn off the inverter DC switch and the battery DC breaker.

When you want to start-up the inverter after rectification, you shall turn on the inverter DC switch and the battery DC breaker.

3.5 SEMS Portal

SEMS Portal is an online monitoring system. After completing the installation of communication connection, you can access www.semsportal.com or download the app by scanning the QR code to monitor your PV plant and device.

Please contact the after-sales for more operation of SEMS Portal.



SEMS Portal App

04 OTHERS

4.1 Error Messages

The error messages below will be displayed on PV Master App or reported by e-mail if an error occurs.

ERROR MESSAGE	EXPLANATION	REASON	SOLUTIONS
Utility Phase Failure	The sequence of the on-grid wire is incorrect	The inverter has detected that the phase angles of L2 and L3 are reversed	The L2 and L3 cables are connected in reverse order.
Utility Loss	Public grid power is not available (power lost or on-grid connection fails)	Inverter does not detect the connection of grid	<ol style="list-style-type: none"> 1. Check (use multi-meter) if AC side has voltage . Make sure grid power is available. 2. Make sure AC cables are connected tightly and well. 3. If all is well, please try to turn off AC breaker and turn on again in 5 mins.
VAC Failure	Grid voltage is not within permissible range	Inverter detects that AC voltage is beyond the normal range required by the safety country	<ol style="list-style-type: none"> 1. Make sure safety country of the inverter is set right. 2. Check (use multi-meter) if the AC voltage (Between L & N) is within a normal range (also on AC breaker side) <ol style="list-style-type: none"> a. If the AC voltage is high, then make sure the AC cable complies with that required on user manual and the AC cable is not too long. b. If the voltage is low, make sure the AC cable is connected well and the jacket of the AC cable is not compressed into the AC terminal. 3. Make sure the grid voltage of your area is stable and within normal range.
FAC Failure	Grid frequency is not within permissible range	Inverter detects that the grid frequency is beyond the normal range required by the safety country	<ol style="list-style-type: none"> 1. Make sure the safety country of the inverter is set right. 2. If safety country is right, then please check on the inverter display if AC frequency (Fac) is within a normal range. 3. If FAC failure only appears a few times and is resolved soon, it should be caused by occasional grid frequency instability.

PV/BAT Overvoltage	The PV or BAT voltage is too high	The total voltage (open-circuit voltage) of each PV string is higher than the maximum DC input voltage of the inverter or the battery voltage is higher than the maximum BAT input voltage of the inverter	<ol style="list-style-type: none"> 1. Check if the PV string Voc is lower than the Max PV input voltage of the inverter. If the Voc of the PV string is high, please decrease the number of PV panels to make sure that Voc is within the maximum DC input voltage range of the inverter. 2. Check if the battery voltage is lower than the maximum battery input voltage of the inverter. If the battery voltage is high, please decrease the number of battery packs to make sure the voltage is within the maximum battery input voltage range of the inverter.
Over Temperature	Temperature inside of the inverter is too high	The inverter's working environment leads to a high temperature condition	<ol style="list-style-type: none"> 1. Try to decrease surrounding temperature. 2. Make sure the installation complies with the instruction on inverter user manual. 3. Try to close the inverter for 15 mins, then start up again.
Isolation Failure	Ground insulation impedance of PV string is too low	Isolation failure could be caused by multiple reasons like that the PV panels are not grounded well, DC cable is broken, PV panels are aged or surrounding humidity is comparatively heavy, etc.	<ol style="list-style-type: none"> 1. Use multi-meter to check if the resistance between earth & inverter frame is close to zero. If it's not, please ensure that the connection is well. 2. If the humidity is too high, isolation failure may occur. 3. Check the resistance between PV1+/PV2+/PV3+/PV4+/BAT+/PV- to earth. If the resistance is lower than the minimum isolation resistance shown in the table(chapter 2.4.2) , check the system wiring connection. 4. Try to restart the inverter. Check if the fault still occurs. If not, it means it is caused by an occasional situation, or contact after-sales
Ground Failure	Ground leakage current is too high	Ground failure could be caused by multiple reasons like that the neutral cable on the AC side is not connected well or the surrounding humidity is comparatively heavy, etc.	Check (use multi-meter) if there is voltage (normally should be close to 0V) between earth & inverter frame. If there is a voltage, it means the neutral & ground cables are not connected well on the AC side. If it happens only in the early morning/ dawn /rainy days with higher air humidity and is recovered soon, it should be normal.

Relay Check Failure	Self checking of relay failure	Neutral & ground cables are not connected well on AC side or just an occasional failure	Check (use multi-meter) if there is high voltage (normally should be lower than 10V) between N & PE cable on the AC side. If the voltage is higher than 10V, it means the Neutral & ground cable are not connected well on AC side or restart inverter.
DC Injection High	/	The inverter detects a higher DC component in AC output	.Try to restart the inverter,check if it still occurs.If not,it is just an occasional situation.Otherwise, contact after-sales immediately.
EEPROM R/W Failure	/	Caused by a strong external magnetic field etc.	Try to restart the inverter,check if it still occurs.If not,it is just an occasional situation.Otherwise, contact after-sales immediately.
SPI Failure	Internal communication failure	Caused by a strong external magnetic field etc.	Try to restart the inverter,check if it still occurs.If not,it is just an occasional situation.Otherwise, contact after-sales immediately.
DC Bus High	BUS voltage is over-high	/	Try to restart the inverter. Check if the fault still occurs. If not, it means it is caused by an occasional situation,or contact after-sales.
Back-Up Over Load	Back-up side is over loaded	Total back-up load power is higher than the back-up nominal output power	Decrease back-up loads to make sure the total load power is lower than back-up nominal output power (please refer to page 24).

4.2 Troubleshooting

Checks Before Turning On AC Power

- **Battery connections:** Confirm that the connections between the ET and battery and that the polarities (+/-) are not reversed. Refer to figure 4.2-1
- **PV input connection:** Confirm the connections between the ET and PV panels and that the polarities (+/-) are not reversed. Refer to figure 4.2-2.
- **On-grid & backup connections:** Confirm that the on-grid is connected to the power grid and that the backup is connected to the loads and that the polarities (e.g. L1/L2/L3/N are in sequence) are not reversed. Refer to figure 4.2-3.
- **Smart Meter & CT connections:** Make sure that the Smart Meter and CT are connected between the house loads and the grid and follow the Smart Meter direction sign on the CT. Refer to figure 4.2-4.

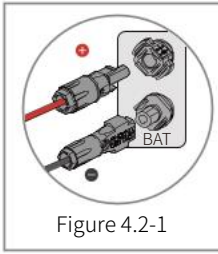

Figure 4.2-1

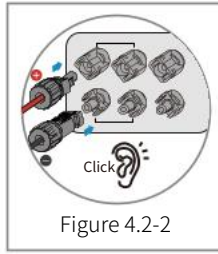

Figure 4.2-2

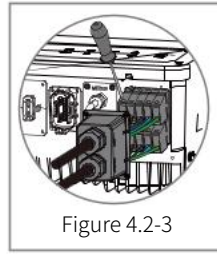

Figure 4.2-3

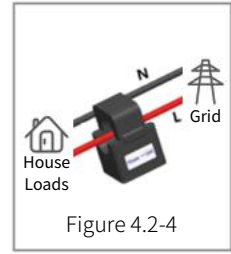
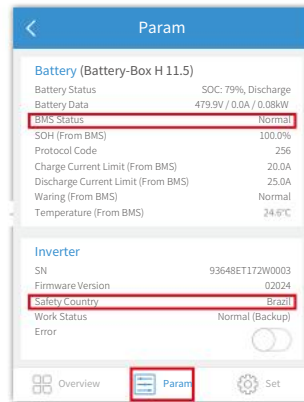
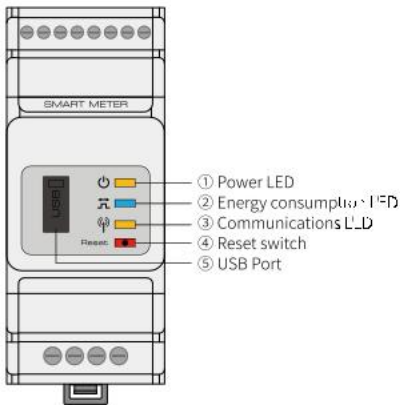

Figure 4.2-4

Checks At Startup And Turning On AC Power

Battery settings, BMS communication and safety country setting:

After connecting the Solar-Wi-Fi* (*The Wi-Fi signal is named as the last 8 characters of the inverter's serial number.). Check the PV Master App "Param" to make sure that the battery type is the same as was installed. Also check that the "Safety Country" setting is correct. If it is not correct, please set it correctly in "Set".



Note: For compatible lithium batteries, the BMS status will display "Normal" after selecting the correct battery company.

Problems During Operation

ET does not start up with battery only

Solution:

Make sure that the battery voltage is greater than 180V. Otherwise, the battery cannot start the ET.

ET did not start up with PV only

Solution:

1. Make sure the PV voltage is greater than 180 (230 V is needed to enter on-grid mode).
2. Make sure that, for the connection between the ET and PV panels, the polarities are (+/-) not reversed.

The ET hybrid inverter does not discharge or output without the PV or when the PV power is less than the load power

Solution:

1. Check whether the communications between the ET and Smart Meter are OK.

2. Make sure the load power is greater than 150W.
 - a. The battery will not discharge continuously unless the load power is greater than 150W.
 - b. If the battery does not discharge when the Meter power is greater than 150W, please check the Smart Meter & CT connections and directions.
3. Make sure the SOC (State of discharge) is greater than 1-DOD (Depth of discharge). Or, if the battery is discharged to below 1-DOD, the battery will only discharge again when SOC is charged to (20%+1-DOD/2) (if battery discharge is needed immediately, the user should restart the battery).
4. Check on the APP whether the charge time has already been set because during the charge time, the battery will not discharge (battery will charge in priority during times of concurrent charge/discharge).

The battery does not charge when the PV power is greater than the load power

Solution:

1. Check the discharge time setting on the APP.
2. Check if the battery is fully charged and also if the battery voltage reaches the "charge voltage".

High power fluctuations during battery charge or discharge

Solution:

1. Check if there are fluctuations in load power.
2. Check if there are fluctuations in PV power.

Battery does not charge

Solution:

1. Make sure that BMS communications are OK on the PV Master App.
2. Check if the CT is connected at the right position and is connected in the right direction per the User Manual.
3. Check if the total load power is significantly higher than the PV power.

Questions & Answers (Q & A)

About the Wi-Fi Configuration

Q: Why can't I find the Solar-Wi-Fi* signal on mobile devices?

A: Normally the Solar-Wi-Fi* signal can be seen immediately after inverter has powered up. However, the Solar-Wi-Fi signal will disappear when the ET connects to the internet. If changes to the settings are required to connect to the router for changes. If you cannot find the Wi-Fi signal or connect to the router, please try to reload the Wi-Fi (please refer to the ET User Manual page 21).

Q: Why can't I connect to the Solar-Wi-Fi* signal on my phone?

A: The Wi-Fi module can only connect to one device at a time. If the signal is already connected to another device at the same time, you will not be able to connect to the signal.

About Battery Operation

Q: Why does the battery not discharge when the grid is not available but it discharges normally when the grid is available?

A: On the APP, the off-grid output and backup function should be turned on to force the battery to discharge under off-grid mode.

Q: Why is there no output on the backup side?

A: For backup supply, "Backup Supply" on the PV Master App must be turned on. In off-grid

mode or when the grid power is disconnected, the "Off-Grid Output Switch" function must be turned on as well.

Note: When turning the "Off-Grid Output Switch" on, do not restart the inverter or battery. Otherwise, the function will be switched off automatically.

Q: Why does the battery SOC suddenly jump to 95% on the Portal?

A: This normally happens when BMS communications fail when using lithium batteries. If the batteries enter float charge mode, the SOC is automatically reset to 95%.

Q: The battery cannot be fully charged to 100%?

A: The battery will stop charging when the battery voltage reaches the charge voltage set in the PV Master App.

Q: Why does the battery switch always trip when it starts up (lithium battery)?

A: The switch of the lithium battery trips because of following reasons:

1. BMS communication fails.
2. The battery SOC is too low and the battery trips to protect itself.
3. An electrical short-circuit has occurred on the battery connection side. Alternatively, for other reasons, Please contact the after-sales department.

Q: Which battery should I use for the ET?

A: The inverter can connect to lithium batteries which have compatibility with it with nominal voltages from 180 V to 600 V. For compatible lithium batteries, please refer to the battery list in the PV Master App.

About PV Master Operation And Monitoring

Q: Why can't I save settings on the PV Master App?

A: This could be caused by losing the connection to Solar-Wi-Fi*.

1. Make sure you have already connected to Solar-Wi-Fi* (make sure that no other devices are connected) or to the router (if Solar-Wi-Fi* is connected to the router). The APP homepage shows the connections.
2. Make sure you restart the inverter 10 mins after you have changed any settings because the inverter will save the settings every 10 mins while operating in normal mode. We recommend that parameter settings be changed when the inverter is in wait mode.

Q: Why are the data displayed on the homepage different from the param page, like charge/discharge, PV value, load value, or grid value?

A: The data refresh frequency is different, so there will be data discrepancies between different pages on the APP as well as between these shown on the portal and APP.

Q: Some columns show NA, like battery SOH, etc. Why does that happen?

A: NA means that the App has not received data from the inverter or server because of communication problems, such as battery communications and the communications between inverter and the App.

About the Smart Meter And Power Limit Function

Q: How to activate the output power limit function?

A: For the ET system, this function can be activated by following these steps:

1. Make sure the Smart Meter connections and communications are functioning correctly.
2. Turn on the export power limit function and set the maximum output power to the grid on the APP.

Note: Even if the output power limit is set to 0W, there might still be a deviation of a maximum

of 100 W when exporting to the grid.

Q: Why is there still power exporting to the grid after I have set the power limit to 0 W?

A: The export limit could theoretically be 0W but there will be a deviation of around 50–100 W for the ET system.

Q: Can I use other meter brands to take over from the Smart Meter in the ET system or to change settings in Smart Meter?

A: No, because the communication protocol is integrated into the inverter and Smart Meter, other meter brands cannot communicate. Also, any change to the manual settings could cause a meter communication failure.

Q: What is the maximum current allowed to pass through the CT on the Smart Meter?

A: The maximum current for the CT is 120A.

Other Questions

Q: Is there a quick way to make the system work?

A: For the shortest resolution, please refer to "ET Quick Installation Instructions" and to the "PV Master App Instructions".

Q: What kind of load can I use to connect to the backup side?

A: Please refer to User Manual on page 12.

Q: Will the warranty of the inverter still be valid if, for some special conditions, we cannot follow 100% of the User Manual instructions for installation or operation?

A: Normally we still provide technical support for problems caused by not following the instructions in the User Manual. However we cannot guarantee any replacements or returns. So, if there are any special conditions for which you cannot follow the instructions 100%, please contact the after-sales department for suggestions.

Q: What is the detection method for anti-islanding protection?

A: AFDPF(Active Frequency Drift with Positive Feedback) + AQDPF(Active Q Drift with Positive Feedback)

4.3 Disclaimer

The ET series and ET Plus series inverters are transported, used and operated under environmental and electrical conditions. The manufacturer has the right to not provide after-sales services or assistance under the following conditions:

- The inverter is damaged during transfer.
- The inverter is out of the warranty year and an extended warranty is not purchased.
- The inverter is installed, refitted, or operated in improper ways without authorization from the manufacturer.
- The inverter is installed or used under improper environmental or technical conditions (as mentioned in this User Manual) and without authorization from manufacturer.
- The installation or configuration of the inverter does not follow the requirements mentioned in this User Manual.
- The inverter is installed or operated contrary to the requirements or warnings mentioned in this User Manual.
- The inverter is broken or damaged by any force majeure, such as lightning, earthquake, fire hazard, storm and volcanic eruption etc.

- The inverter is disassembled, changed or updated on software or hardware without authorization from the manufacturer.
- The Inverter is installed, used, or operated against any related provisions contained in international or local policies or regulations.
- Any incompatible batteries, loads or other devices are connected to the ET system.
- Specifications are subject to change without notice. Every effort has been made to make this document complete, accurate and up-to-date. However, GoodWe may need to make some improvements under certain circumstances without advance notice. GoodWe shall not be responsible for any loss caused by this document including, but not limited to omissions, errors, typographical errors, arithmetical errors or listing errors in this document. If you have any questions or suggestions, please contact GoodWe after-sale.

Note: The manufacturer retains the right to explain all of the contents in this User Manual. To insure IP66, the inverter must be sealed well; please install the inverters within one day of unpacking; otherwise, please seal all unused terminals /holes; unused terminals/holes are not allowed to remain open; and confirm that there is no risk of water or dust entering any terminals/holes.

Maintenance

Maintaining Item	Maintaining Method	Maintaining Period
System Clean	Check the heat sink, air intake, and air outlet for foreign matter or dust.	Once 6-12 months
DC Switch	Turn the DC switch on and off ten consecutive times to make sure that it is working properly.	Once a year
Electrical Connection	Check whether the cables are securely connected. Check whether the cables are broken, or whether there is any exposed copper core.	Once 6-12 months
Sealing	Check whether all the terminals and ports are properly sealed. Reseal the cable hole if it is not sealed or too big.	Once a year
THDi Test	For Australia requirements, in the THDi test, there should add Zref between inverter and mains. L: $0.24 \Omega + j0.15 \Omega$; N: $0.16 \Omega + j0.10 \Omega$ L: $0.15 \Omega + j0.15 \Omega$; N: $0.1 \Omega + j0.1 \Omega$	As needed

- WiFi module: Replace or remove the WiFi module using the WiFi module remover, which is delivered in the package. Remove the communication terminal next to the WiFi module first. Place the remover horizontally on the WiFi module, then turn the remover to 90° to fasten it and the module together. Press the remover and pull the module to remove it as the following figure shows.

Notice: If you need to repair or replace parts, contact the after sales service.

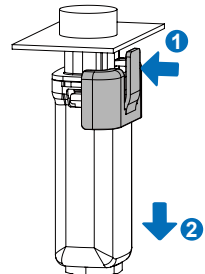

4.4 Technical Parameters

Technical Data	GW5KL-ET	GW6KL-ET	GW8KL-ET	GW10KL-ET
Battery Input Data				
Battery Type	Li-Ion	Li-Ion	Li-Ion	Li-Ion
Nominal Battery Voltage (V)	500	500	500	500
Battery Voltage Range (V)	180~600	180~600	180~600	180~600
Max. Continuous Charging Current (A)	25	25	25	25
Max. Continuous Discharging Current (A)	25	25	25	25
Max. Charge Power (W)	7,500	7,800	9,600	10,000
Max. Discharge Power (W)	7,500	7,800	9,600	10,000
PV String Input Data				
Max. Input Power (W)	6,650	7,980	10,640	13,300
Max. Input Voltage (V)* ¹	1000	1000	1000	1000
MPPT Operating Voltage Range (V)* ²	200~850	200~850	200~850	200~850
MPPT Voltage Range at Nominal Power (V)* ³	240~850	285~850	260~850	320~850
Start-up Voltage (V)	180	180	180	180
Nominal Input Voltage (V)	620	620	620	620
Max. Input Current per MPPT (A)	12.5	12.5	12.5/22	12.5/22
Max. Short Circuit Current per MPPT (A)	15.2	15.2	15.2/27.6	15.2/27.6
Max. Backfeed Current to The Array (A)	0	0	0	0
Number of MPP Trackers	2	2	2	2
Number of Strings per MPPT	1	1	1/2	1/2
AC Output Data (On-grid)				
Nominal Apparent Power Output to Utility Grid (VA)	5,000	6,000	8,000	10,000
Max. Apparent Power Output to Utility Grid (VA)* ^{2*4}	5,500	6,600	8,800	11,000
Nominal Apparent Power from Utility Grid (VA)	10,000	12,000	15,000	15,000
Max. Apparent Power from Utility Grid (VA)	10,000	12,000	15,000	15,000

Nominal Output Voltage (V)	400/380, 3L/N/PE	400/380, 3L/N/PE	400/380, 3L/N/PE	400/380, 3L/N/PE
Output Voltage Range (V)	0~300	0~300	0~300	0~300
Nominal AC Grid Frequency (Hz)	50/60	50/60	50/60	50/60
AC Grid Frequency Range (Hz)	45~65	45~65	45~65	45~65
Max. AC Current Output to Utility Grid (A)	8.5	10.5	13.5	16.5
Max. AC Current From Utility Grid (A)	15.2	18.2	22.7	22.7
Max. Output Fault Current (Peak and Duration) (A)"	45@2μs	45@2μs	45@2μs	45@2μs
Inrush Current (Peak and Duration) (A)	45@2μs	45@2μs	45@2μs	45@2μs
Nominal Output Current (A)	7.5	9	12	14.5
Power Factor	~1 (Adjustable from 0.8 leading to 0.8 lagging)			
Max. Total Harmonic Distortion	<3%	<3%	<3%	<3%
Maximum Output Overcurrent Protection (A)	45	45	45	45
AC Output Data (Back-up)				
Back-up Nominal Apparent Power (VA)	5,000	6,000	8,000	10,000
Max. Output Apparent Power (VA)*3	5,000 (10,000@60 sec)	6,000 (12,000@60 sec)	8,000 (16,000@60 sec)	10,000 (16,500@60 sec)
Nominal Output Current (A)	7.5	9	12	14.5
Max. Output Current (A)	8.5	10.5	13.5	16.5
Max. Output Fault Current (Peak and Duration) (A)	45@2μs	45@2μs	45@2μs	45@2μs
Inrush Current (Peak and Duration) (A)	45@2μs	45@2μs	45@2μs	45@2μs
Maximum Output Overcurrent Protection (A)	45	45	45	45
Nominal Output Voltage (V)	400/380	400/380	400/380	400/380
Nominal Output Frequency (Hz)	50/60	50/60	50/60	50/60
Output THDv (@Linear Load)	<3%	<3%	<3%	<3%
Efficiency				
Max. Efficiency	97.60%	97.60%	97.60%	97.60%
European Efficiency	96.80%	96.80%	96.80%	96.80%

Max. Battery to AC Efficiency	97.50%	97.50%	97.50%	97.50%
MPPT Efficiency	99.90%	99.90%	99.90%	99.90%
Protection				
PV Insulation Resistance Detection	Integrated	Integrated	Integrated	Integrated
Residual Current Monitoring	Integrated	Integrated	Integrated	Integrated
PV Reverse Polarity Protection	Integrated	Integrated	Integrated	Integrated
Anti-islanding Protection	Integrated	Integrated	Integrated	Integrated
AC Overcurrent Protection	Integrated	Integrated	Integrated	Integrated
AC Short Circuit Protection	Integrated	Integrated	Integrated	Integrated
AC Overvoltage Protection	Integrated	Integrated	Integrated	Integrated
DC Switch	Optional	Optional	Optional	Optional
DC Surge Protection	Type III	Type III	Type III	Type III
AC Surge Protection	Type III	Type III	Type III	Type III
Remote Shutdown	Integrated	Integrated	Integrated	Integrated
General Data				
Operating Temperature Range (°C)	-35~+60	-35~+60	-35~+60	-35~+60
Relative Humidity	0~95%	0~95%	0~95%	0~95%
Max. Operating Altitude (m)	4000	4000	4000	4000
Cooling Method	Natural Convection			
User Interface	LED, APP	LED, APP	LED, APP	LED, APP
Communication with BMS*6	RS485, CAN	RS485, CAN	RS485, CAN	RS485, CAN
Communication with Meter	RS485	RS485	RS485	RS485
Communication with Portal	WiFi / WiFi+LAN (Optional) / 4G (Optional)			
Weight (kg)	24	24	25	25
Dimension (W×H×D mm)	415×516×180			
Noise Emission (dB)	<30	<30	<30	<30
Topology	Non-isolated	Non-isolated	Non-isolated	Non-isolated
Self-consumption at Night (W)*7	<15	<15	<15	<15
Ingress Protection Rating	IP66	IP66	IP66	IP66
DC Connector	MC4 (4~6mm ²)			

AC Connector	Feed-Through Terminal Blocks UW10			
Environmental Category	4K4H			
Pollution Degree	III			
Overvoltage Category	DC II / AC III			
Storage Temperature (°C)	-40~+85			
The Decisive Voltage Class (DVC)	Battery: C PV: C AC: C Com: A			
Mounting Method	Wall Mounted			
Active Anti-islanding Method	AFDPF + AQDPF *5			
Type of Electrical Supply System	Three phase Grid			
Country of Manufacture	China	China	China	China
Certification*8				
Grid Standards	AS/NZS 4777.2:2015			
Safety Regulation	IEC62109-1&2			
EMC	EN61000-6-1, EN61000-6-2, EN61000-6-3, EN61000-6-4, EN61000-4-16, EN61000-4-18, EN61000-4-29			
<p>*1: For 1000V system, Maximum operating voltage is 950V. *2: According to the local grid regulation. *3: Can be reached only if PV and battery power is enough. *4: For Belgium Max. Output Apparent Power(VA), GW5KN-ET is 5000; GW6.5KN-ET is 6500; GW8KN-ET is 8000; GW10KN-ET is 10000. *5: AFDPF: Active Frequency Drift with Positive Feedback, AQDPF: Active Q Drift with Positive Feedback. *6: CAN communication is configured default. If RS485 communication is used, please replace the corresponding communication line. *7: No Back-up Output. *8: Not all certifications & standards listed, check the official website for details</p>				

Technical Data	GW5K-ET	GW6.5K-ET	GW8K-ET	GW10K-ET
Battery Input Data				
Battery Type	Li-Ion	Li-Ion	Li-Ion	Li-Ion
Nominal Battery Voltage (V)	500	500	500	500
Battery Voltage Range (V)	180~600	180~600	180~600	180~600
Max. Continuous Charging Current (A)	25	25	25	25
Max. Continuous Discharging Current (A)	25	25	25	25
Max. Charge Power (W)	7,500	8,450	9,600	10,000
Max. Discharge Power (W)	7,500	8,450	9,600	10,000
PV String Input Data				
Max. Input Power (W)	7,500	9,700	12,000	15,000
Max. Input Voltage (V)*1	1000	1000	1000	1000
MPPT Operating Voltage Range (V)*2	200~850	200~850	200~850	200~850
MPPT Voltage Range at Nominal Power (V)*3	240~850	310~850	380~850	460~850
Start-up Voltage (V)	180	180	180	180
Nominal Input Voltage (V)	620	620	620	620
Max. Input Current per MPPT (A)	12.5	12.5	12.5	12.5
Max. Short Circuit Current per MPPT (A)	15.2	15.2	15.2	15.2
Max. Backfeed Current to The Array (A)	0	0	0	0
Number of MPP Trackers	2	2	2	2
Number of Strings per MPPT	1	1	1	1
AC Output Data (On-grid)				
Nominal Apparent Power Output to Utility Grid (VA)	5,000	6,500	8,000	10,000
Max. Apparent Power Output to Utility Grid (VA)*2*4	5,500	7,150	8,800	11,000
Nominal Apparent Power from Utility Grid (VA)	10,000	13,000	15,000	15,000

Max. Apparent Power from Utility Grid (VA)	10,000	13,000	15,000	15,000
Nominal Output Voltage (V)	400/380, 3L/N/PE	400/380, 3L/N/PE	400/380, 3L/N/PE	400/380, 3L/N/PE
Output Voltage Range (V)	0~300	0~300	0~300	0~300
Nominal AC Grid Frequency (Hz)	50/60	50/60	50/60	50/60
AC Grid Frequency Range (Hz)	45~65	45~65	45~65	45~65
Max. AC Current Output to Utility Grid (A)	8.5	10.8	13.5	16.5
Max. AC Current From Utility Grid (A)	15.2	19.7	22.7	22.7
Max. Output Fault Current (Peak and Duration) (A)	45@2 μ s	45@2 μ s	45@2 μ s	45@2 μ s
Inrush Current (Peak and Duration) (A)	45@2 μ s	45@2 μ s	45@2 μ s	45@2 μ s
Nominal Output Current (A)	7.5	9.5	12	14.5
Power Factor	~1 (Adjustable from 0.8 leading to 0.8 lagging)			
Max. Total Harmonic Distortion	<3%	<3%	<3%	<3%
Maximum Output Overcurrent Protection (A)	45	45	45	45
AC Output Data (Back-up)				
Back-up Nominal Apparent Power (VA)	5,000	6,500	8,000	10,000
Max. Output Apparent Power (VA)*3	5,000 (10,000 @ 60 sec)	6,500 (13,000 @ 60 sec)	8,000 (16,000 @ 60 sec)	10,000 (16,500 @ 60 sec)
Nominal Output Current (A)	7.5	9.5	12	14.5
Max. Output Current (A)	8.5	10.8	13.5	16.5
Max. Output Fault Current (Peak and Duration) (A)	45@2 μ s	45@2 μ s	45@2 μ s	45@2 μ s
Inrush Current (Peak and Duration) (A)	45@2 μ s	45@2 μ s	45@2 μ s	45@2 μ s
Maximum Output Overcurrent Protection (A)	45	45	45	45
Nominal Output Voltage (V)	400/380	400/380	400/380	400/380
Nominal Output Frequency (Hz)	50/60	50/60	50/60	50/60
Output THDv (@Linear Load)	<3%	<3%	<3%	<3%

Efficiency				
Max. Efficiency	98.00%	98.00%	98.20%	98.20%
European Efficiency	97.20%	97.20%	97.50%	97.50%
Max. Battery to AC Efficiency	97.50%	97.50%	97.50%	97.50%
MPPT Efficiency	99.90%	99.90%	99.90%	99.90%
Protection				
PV Insulation Resistance Detection	Integrated	Integrated	Integrated	Integrated
Residual Current Monitoring	Integrated	Integrated	Integrated	Integrated
PV Reverse Polarity Protection	Integrated	Integrated	Integrated	Integrated
Anti-islanding Protection	Integrated	Integrated	Integrated	Integrated
AC Overcurrent Protection	Integrated	Integrated	Integrated	Integrated
AC Short Circuit Protection	Integrated	Integrated	Integrated	Integrated
AC Overvoltage Protection	Integrated	Integrated	Integrated	Integrated
DC Switch	Integrated	Integrated	Integrated	Integrated
DC Surge Protection	Type II	Type II	Type II	Type II
AC Surge Protection	Type III	Type III	Type III	Type III
Remote Shutdown	Integrated	Integrated	Integrated	Integrated
General Data				
Operating Temperature Range (°C)	-35~+60	-35~+60	-35~+60	-35~+60
Relative Humidity	0~95%	0~95%	0~95%	0~95%
Max. Operating Altitude (m)	4000	4000	4000	4000
Cooling Method	Natural Convection			
User Interface	LED, APP	LED, APP	LED, APP	LED, APP
Communication with BMS*6	RS485, CAN	RS485, CAN	RS485, CAN	RS485, CAN
Communication with Meter	RS485	RS485	RS485	RS485
Communication with Portal	WiFi	WiFi	WiFi	WiFi
Weight (kg)	24	24	24	24
Dimension (W×H×D mm)	415×516×180			
Noise Emission (dB)	<30	<30	<30	<30
Topology	Non-isolated			
Self-consumption at Night (W)*7	<15	<15	<15	<15

Ingress Protection Rating	IP66	IP66	IP66	IP66
DC Connector	MC4 (4~6mm ²)			
AC Connector	Feed-Through Terminal Blocks UW10			
Environmental Category	4K4H			
Pollution Degree	III			
Overtoltage Category	DC II / AC III			
Storage Temperature (°C)	-40~+85			
The Decisive Voltage Class (DVC)	Battery: C PV: C AC: C Com: A			
Mounting Method	Wall Mounted			
Active Anti-islanding Method	AFDPF + AQDPF *5			
Type of Electrical Supply System	Three phase Grid			
Country of Manufacture	China	China	China	China
Certification*8				
Grid Regulation	VDE-AR-N 4105, VDE 0126-1-1, EN 50549-1, G98, G99, G100, CEI 0-21			
Safety Regulation	IEC62109-1&2			
EMC	EN61000-6-1, EN61000-6-2, EN61000-6-3, EN61000-6-4, EN61000-4-16, EN61000-4-18, EN61000-4-29			
<p>*1: For 1000V system, Maximum operating voltage is 950V. *2: According to the local grid regulation. *3: Can be reached only if PV and battery power is enough. *4: For Belgium Max. Output Apparent Power(VA), GW5K-ET is 5000; GW6.5K-ET is 6500; GW8K-ET is 8000; GW10K-ET is 10000. *5: AFDPF: Active Frequency Drift with Positive Feedback, AQDPF: Active Q Drift with Positive Feedback. *6: CAN communication is configured default. If RS485 communication is used, please replace the corresponding communication line. *7: No Back-up Output. *8: Not all certifications & standards listed, check the official website for details.</p>				

Technical Data	GW5KN-ET	GW6.5KN-ET	GW8KN-ET	GW10KN-ET
Battery Input Data				
Battery Type	Li-Ion	Li-Ion	Li-Ion	Li-Ion
Nominal Battery Voltage (V)	500	500	500	500
Battery Voltage Range (V)	180~600	180~600	180~600	180~600
Max. Continuous Charging Current (A)	25	25	25	25
"Max. Continuous Discharging Current (A)"	25	25	25	25
Max. Charge Power (W)	7,500	8,450	9,600	10,000
Max. Discharge Power (W)	7,500	8,450	9,600	10,000
PV String Input Data				
Max. Input Power (W)	7,500	9,700	12,000	15,000
Max. Input Voltage (V)*1	1000	1000	1000	1000
MPPT Operating Voltage Range (V)*2	200~850	200~850	200~850	200~850
MPPT Voltage Range at Nominal Power (V)*3	240~850	310~850	380~850	460~850
Start-up Voltage (V)	180	180	180	180
Nominal Input Voltage (V)	620	620	620	620
Max. Input Current per MPPT (A)	16	16	16	16
Max. Short Circuit Current per MPPT (A)	21.2	21.2	21.2	21.2
Max. Backfeed Current to The Array (A)	0	0	0	0
Number of MPP Trackers	2	2	2	2
Number of Strings per MPPT	1	1	1	1
AC Output Data (On-grid)				
Nominal Apparent Power Output to Utility Grid (VA)	5,000	6,500	8,000	10,000
Max. Apparent Power Output to Utility Grid (VA)*2**4	5,500	7,150	8,800	11,000
Nominal Apparent Power from Utility Grid (VA)	10,000	13,000	15,000	15,000

Max. Apparent Power from Utility Grid (VA)	10,000	13,000	15,000	15,000
Nominal Output Voltage (V)	400/380, 3L/N/PE	400/380, 3L/N/PE	400/380, 3L/N/PE	400/380, 3L/N/PE
Output Voltage Range (V)	0~300	0~300	0~300	0~300
Nominal AC Grid Frequency (Hz)	50/60	50/60	50/60	50/60
AC Grid Frequency Range (Hz)	45~65	45~65	45~65	45~65
Max. AC Current Output to Utility Grid (A)	8.5	10.8	13.5	16.5
Max. AC Current From Utility Grid (A)	15.2	19.7	22.7	22.7
Max. Output Fault Current (Peak and Duration) (A)	45@2 μ s	45@2 μ s	45@2 μ s	45@2 μ s
Inrush Current (Peak and Duration) (A)	45@2 μ s	45@2 μ s	45@2 μ s	45@2 μ s
Nominal Output Current (A)	7.5	9.5	12	14.5
Power Factor	~1 (Adjustable from 0.8 leading to 0.8 lagging)			
Max. Total Harmonic Distortion	<3%	<3%	<3%	<3%
Maximum Output Overcurrent Protection (A)	45	45	45	45
AC Output Data (Back-up)				
Back-up Nominal Apparent Power (VA)	5,000	6,500	8,000	10,000
Max. Output Apparent Power (VA)*3	5,000 (10,000 @ 60 sec)	6,500 (13,000 @ 60 sec)	8,000 (16,000 @ 60 sec)	10,000 (16,500 @ 60 sec)
Nominal Output Current (A)	7.5	9.5	12	14.5
Max. Output Current (A)	8.5	10.8	13.5	16.5
Max. Output Fault Current (Peak and Duration) (A)	45@2 μ s	45@2 μ s	45@2 μ s	45@2 μ s
Inrush Current (Peak and Duration) (A)	45@2 μ s	45@2 μ s	45@2 μ s	45@2 μ s
Maximum Output Overcurrent Protection (A)	45	45	45	45
Nominal Output Voltage (V)	400/380	400/380	400/380	400/380

Nominal Output Frequency (Hz)	50/60	50/60	50/60	50/60
Output THDv (@Linear Load)	<3%	<3%	<3%	<3%
Efficiency				
Max. Efficiency	98.00%	98.00%	98.20%	98.20%
European Efficiency	97.20%	97.20%	97.50%	97.50%
Max. Battery to AC Efficiency	97.50%	97.50%	97.50%	97.50%
MPPT Efficiency	99.90%	99.90%	99.90%	99.90%
Protection				
PV Insulation Resistance Detection	Integrated	Integrated	Integrated	Integrated
Residual Current Monitoring	Integrated	Integrated	Integrated	Integrated
PV Reverse Polarity Protection	Integrated	Integrated	Integrated	Integrated
Anti-islanding Protection	Integrated	Integrated	Integrated	Integrated
AC Overcurrent Protection	Integrated	Integrated	Integrated	Integrated
AC Short Circuit Protection	Integrated	Integrated	Integrated	Integrated
AC Overvoltage Protection	Integrated	Integrated	Integrated	Integrated
DC Switch	Integrated	Integrated	Integrated	Integrated
DC Surge Protection	Type II	Type II	Type II	Type II
AC Surge Protection	Type III	Type III	Type III	Type III
Remote Shutdown	Integrated	Integrated	Integrated	Integrated
General Data				
Operating Temperature Range (°C)	-35~+60	-35~+60	-35~+60	-35~+60
Relative Humidity	0~95%	0~95%	0~95%	0~95%
Max. Operating Altitude (m)	4000	4000	4000	4000
Cooling Method	Natural Convection			
User Interface	LED, APP	LED, APP	LED, APP	LED, APP
Communication with BMS ^{*6}	RS485, CAN	RS485, CAN	RS485, CAN	RS485, CAN
Communication with Meter	RS485	RS485	RS485	RS485
Communication with Portal	WiFi / WiFi+LAN (Optional) / 4G (Optional)			
Weight (kg)	24	24	24	24
Dimension (W×H×D mm)	415×516×180			
Noise Emission (dB)	<30	<30	<30	<30

Topology	Non-isolated			
Self-consumption at Night (W) ^{*7}	<15	<15	<15	<15
Ingress Protection Rating	IP66	IP66	IP66	IP66
DC Connector	MC4 (4~6mm ²)			
AC Connector	Feed-Through Terminal Blocks UW10			
Environmental Category	4K4H	4K4H	4K4H	4K4H
Pollution Degree	III	III	III	III
Overtoltage Category	DC II / AC III	DC II / AC III	DC II / AC III	DC II / AC III
Storage Temperature (°C)	-40~+85	-40~+85	-40~+85	-40~+85
The Decisive Voltage Class (DVC)	Battery: C PV: C AC: C Com: A			
Mounting Method	Wall Mounted			
Active Anti-islanding Method	AFDPF + AQDPF ^{*5}			
Type of Electrical Supply System	Three phase Grid			
Country of Manufacture	China	China	China	China
Certification ^{*8}				
Grid Regulation	VDE-AR-N 4105, VDE 0126-1-1, EN 50549-1, G98, G99, G100, CEI 0-21			
Safety Regulation	IEC62109-1&2			
EMC	EN61000-6-1, EN61000-6-2, EN61000-6-3, EN61000-6-4, EN61000-4-16, EN61000-4-18, EN61000-4-29			
<p>*1: For 1000V system, Maximum operating voltage is 950V. *2: According to the local grid regulation. *3: Can be reached only if PV and battery power is enough. *4: For Belgium Max. Output Apparent Power(VA), GW5KN-ET is 5000; GW6.5KN-ET is 6500; GW8KN-ET is 8000; GW10KN-ET is 10000. *5: AFDPF: Active Frequency Drift with Positive Feedback, AQDPF: Active Q Drift with Positive Feedback. *6: CAN communication is configured default. If RS485 communication is used, please replace the corresponding communication line. *7: No Back-up Output. *8: Not all certifications & standards listed, check the official website for details.</p>				

4.5 Quick Checklist To Avoid Dangerous Conditions

1. The inverter must not be installed near flammable or explosive materials or near equipment with strong electromagnetic fields. Please refer to page 6.
2. Remember that this inverter is heavy! Please be careful when lifting from the package. Please refer to page 7.
3. Make sure that the battery breaker is off and that the nominal battery voltage meets ET specifications before connecting the battery to the inverter; make sure that the inverter is totally isolated from both PV and AC power. Please refer to page 9.
4. Make sure that the inverter is totally isolated from all DC or AC power before connecting the AC cable. Please refer to page 11.
5. Make sure the AC cable is totally isolated from AC power before connecting the Smart Meter and CT. Please refer to page 14.

Appendix

Protection category definition

Moisture location category definition

Moisture Parameters	Level		
	3K3	4K3	4K4H
Temperature Range	0~+40°C	-33~+40°C	-20~+55°C
Moisture Parameters	5%~85%	15%~100%	4%~100%

Environment category definition

Environment Condition	Ambient Temperature	Relative Humidity	Applied to
Outdoor	-20~50°C	4%~100%	PD3
Indoor Unconditioned	-20~50°C	5%~95%	PD3
Indoor conditioned	0~40°C	5%~85%	PD2

Overvoltage category definition

Category I	Applies to equipment connected to a circuit where measures have been taken to reduce transient overvoltage to a low level.
Category II	Applies to equipment not permanently connected to the installation. Examples are appliances, portables tools and other plug-connected equipment.
Category III	Applies to a fixed equipment downstream, including the main distribution board. Examples are switchgear and other equipment in an industrial installation.
Category IV	Applies to equipment permanently connected at the origin of an installation (upstream of the main distribution board). Examples are electricity meters, primary over-current protection equipment and other equipment connected directly to outdoor open lines.

Pollution degree definition

Pollution Degree I	No pollution or only dry, non-conductive pollution occurs. The pollution has no influence.
Pollution Degree II	Normally only non-conductive pollution occurs. Occasionally, however, a temporary conductivity caused by condensation must be expected.
Pollution Degree III	Conductive pollution occurs, or dry, non-conductive pollution occurs, which becomes conductive due to condensation, which is expected.
Pollution Degree IV	Persistent conductive pollution occurs, for example, the pollution caused by conductive dust, rain or snow.



Official Website

GoodWe Technologies Co., Ltd.

 No. 90 Zijin Rd., New District, Suzhou, 215011, China

 www.goodwe.com

 service@goodwe.com



Local Contacts