

Residential Smart Inverter Solutions

ET G2 6-15kW+Lynx Home F/Lynx Home D

User Manual

V1.7-2025-05-19

Copyright Statement:

Copyright © GoodWe Technologies Co., Ltd. 2025. All rights reserved.

No part of this manual can be reproduced or transmitted to the public platform in any form or by any means without the prior written authorization of GoodWe Technologies Co., Ltd.

Trademarks

GOODWE and other GOODWE trademarks are trademarks of GoodWe Technologies Co., Ltd. All other trademarks or registered trademarks mentioned in this manual are owned by the company.

NOTICE

The information in this user manual is subject to change due to product updates or other reasons. This manual cannot replace the product safety labels unless otherwise specified. All descriptions here are for guidance only.

1 About This Manual

1.1 Overview

The energy storage system consists of inverter, battery system, and smart meter. This manual describes the product information, installation, electrical connection, commissioning, troubleshooting and maintenance of the system. Read through this manual before installing and operating the products. This manual is subject to update without notice. For more product details and latest documents, visit <https://en.goodwe.com/>.

1.2 Applicable Model

The energy storage system consists the following products:

Product type	Product information	Description
Inverter	ET G2 6-15kW	Rated output power: 6kW - 15kW.
Battery system	Lynx Home F G2	Capacity of single battery system: 6.4kWh - 28.8kWh. Max capacity of parallel connected battery systems: 230.4kWh.
	Lynx Home F, Lynx Home F Plus+	Capacity of single battery system: 6.6kWh - 16.38kWh. Max capacity of parallel connected battery systems: 131.04kWh.
	Lynx Home D	Capacity of single battery system: 5kWh. Max capacity of parallel connected battery systems: 40kWh.
Smart meter	GM3000	Monitors and detects running data in the system, such as voltage, current, etc..
	GM330	
Smart dongle	WiFi/LAN Kit-20	Uploads the system running information to the monitoring platform through WiFi or LAN.
	LS4G Kit-CN, 4G Kit-CN, 4G Kit-CN-G20 or 4G Kit-CN-G21	Only applicable to China and in a single inverter system.
	Ezlink3000	Connects to the master inverter when multi inverters are parallel connected. Uploads the system running information to the monitoring platform through WiFi or LAN.

1.3 Symbol Definition



Indicates a high-level hazard that, if not avoided, will result in death or serious injury.

 **WARNING**

Indicates a medium-level hazard that, if not avoided, could result in death or serious injury.

 **CAUTION**

Indicates a low-level hazard that, if not avoided, could result in minor or moderate injury.

NOTICE

Highlight and supplement the texts. Or some skills and methods to solve product-related problems to save time.

2 Safety Precautions

Please strictly follow these safety instructions in the user manual during the operation.

WARNING

The products are designed and tested strictly to comply with related safety rules. Read and follow all the safety instructions and cautions before any operations. Improper operation might cause personal injury or property damage as the products are electrical equipment.

2.1 General Safety

NOTICE

- The information in this user manual is subject to change due to product updates or other reasons. This manual cannot replace the product safety labels unless otherwise specified. All descriptions here are for guidance only.
- Before installations, read through the user manual to learn about the product and the precautions.
- All operations should be performed by trained and knowledgeable technicians who are familiar with local standards and safety regulations.
- Use insulating tools and wear personal protective equipment (PPE) when operating the equipment to ensure personal safety. Wear anti-static gloves, cloths, and wrist strips when touching electronic devices to protect the equipment from damage.
- Unauthorized dismantling or modification may damage the equipment, the damage is not covered under the warranty.
- Strictly follow the installation, operation, and configuration instructions in this manual. The manufacturer shall not be liable for equipment damage or personal injury if you do not follow the instructions. For more warranty details, please visit:
<https://www.goodwe.com/warrantyrelated.html>.

2.2 Personnel Requirements

NOTICE

- Personnel who install or maintain the equipment must be strictly trained, learn about safety precautions and correct operations.
- Only qualified professionals or trained personnel are allowed to install, operate, maintain, and replace the equipment or parts.

2.3 System Installation

DANGER

- Disconnect the upstream and downstream switches to power off the equipment before any electrical connections. Do not work with power on. Otherwise, an electric shock may occur. Do not work with power on. Otherwise, an electric shock may occur.
- Install a breaker at the voltage input side of the equipment to prevent personal injury or equipment damage caused by energized electrical work.
- All operations such as transportation, storage, installation, use and maintenance shall comply with applicable laws, regulations, standards and specifications.

- Perform electrical connections in compliance with local laws, regulations, standards and specifications. Including operations, cables, and component specifications.
- Connect cables using the connectors included in the package. The manufacturer shall not be liable for equipment damage if other connectors are used.
- Ensure all cables are connected tightly, securely, and correctly. Inappropriate wiring may cause poor contacts and damage the equipment.
- The PE cables must be connected and secured properly.
- To protect the equipment and components from damage during transportation, ensure that the transportation personnel are professionally trained. All operations during the transportation have to be recorded. The equipment shall be kept in balance, thus avoiding falling down.
- The equipment is heavy. Please equip the corresponding personnel according to its weight, so that the equipment does not exceed the weight range of the human body can carry, and cause personnel injury.
- Keep the equipment stable to avoid dumping, which can result in equipment damage and personal injuries.
- Do not wear any metal thing when moving, installing, or commissioning the equipment. Otherwise, it will cause electrical shock or damages to the equipment.
- Do not put any metal parts on the equipment, otherwise it will cause electrical shock.



WARNING

- Do not apply mechanical load to the terminals, otherwise the terminals can be damaged.
- If the cable bears too much tension, the connection may be poor. Reserve a certain length of the cable before connecting it to corresponding ports.
- Tie the cables of the same type together, and place cables of different types at least 30mm apart. Do not place the cables entangled or crossed.
- Place the cables at least 30mm away from the heating components or heat sources, otherwise the insulation layer of the cables may be aging or broken due to high temperature.

2.3.1 PV String Safety

WARNING

- Ensure the component frames and the bracket system are securely grounded.
- Ensure the DC cables are connected tightly, securely and correctly. Inappropriate wiring may cause poor contacts or high impedances, and damage the inverter.
- Measure the DC cable using the multimeter to avoid reverse polarity connection. Also, the voltage should be under the max DC input voltage. The manufacturer shall not be liable for the damage caused by reverse connection and overvoltage.
- The PV strings cannot be grounded. Ensure the minimum insulation resistance of PV string to the ground meets the minimum insulation resistance requirements before connecting the PV string to the inverter ($R = \text{maximum input voltage (V)} / 30\text{mA}$).
- Do not connect one PV string to more than one inverter at the same time. Otherwise, it may cause damage to the inverter.
- The PV modules used with the inverter must have an IEC61730 class A rating.
- The inverter output power may decrease if the PV string inputs high voltage or current.

2.3.2 Inverter Safety

WARNING

- The voltage and frequency at the connecting point should meet the on-grid requirements.
- Additional protective devices like circuit breakers or fuses are recommended on the AC side. Specification of the protective device should be at least 1.25 times the maximum AC output current.
- The arc fault alarms will be cleared automatically if the alarms are triggered less than 5 times in 24 hours. The inverter will shutdown for protection after the 5th electric arc fault. The inverter can operate normally after the fault is solved.
- BACK-UP is not recommended if the PV system is not configured with batteries. Otherwise, there may be a risk of system power outage.
- The inverter output power may decrease when the grid voltage and frequency changes.

2.3.3 Battery Safety

DANGER

- The battery system exists high voltage during the equipment running. Keep Power Off before any operations to avoid danger. Strictly follow all safety precautions outlined in this manual and safety labels on the equipment during the operation.
- Do not disassemble, modify, or replace any part of the battery or the power control unit without official authorization from the manufacturer. Otherwise, it will cause electrical shock or damages to the equipment, which shall not be borne by the manufacturer.
- Do not hit, pull, drag, squeeze or step on the equipment or put the battery into fire. Otherwise, the battery may explode.
- Do not place the battery in a high temperature environment. Make sure that there is no direct sunlight and no heat source near the battery. When the ambient temperature exceeds 60 °C, it will cause fire.
- Do not use the battery or the power control unit if it is defective, broken, or damaged. Damaged battery may leak electrolyte.
- Do not move the battery system while it is working.
- Contact after-sales service if the battery shall be replaced or added.
- A short circuit in the battery may cause personal injury. The instantaneous high current caused by a short circuit can release a large amount of energy and may cause a fire.

WARNING

- If the battery discharged completely, please charge it in strict accordance with the corresponding model's user manual.
- Factors such as: temperature, humidity, weather conditions, etc. may limit the battery's current and affect its load.
- Contact after-sale service immediately if the battery is not able to be started. Otherwise, the battery might be damaged permanently.

Emergency Measures

● Battery Electrolyte Leakage

If the battery module leaks electrolyte, avoid contact with the leaking liquid or gas. The electrolyte is corrosive. It will cause skin irritation or chemical burn to the operator. Anyone contact the leaked substance accidentally has to do as following:

- Breath in the leaked substance: Evacuate from the polluted area, and seek immediate medical assistance.
 - Eye contact: Rinse your eyes for at least 15 minutes with clean water and seek immediate medical assistance.
 - Skin contact: Thoroughly wash the touch area with soap and clean water, and seek immediate medical assistance.
 - Ingestion: Induce vomiting, and seek immediate medical assistance.
- ### ● Fire
- The battery may explode when the ambient temperature exceeds 150°C. Poisonous and hazardous gas may be released if the battery is on fire.
 - In the event of a fire, please make sure that the carbon dioxide extinguisher or Novec1230 or FM-200 is nearby.
 - The fire cannot be put out by ABC dry powder extinguisher. Firefighters are required to wear full protective clothing and self-contained breathing apparatus.

2.3.4 Smart Meter Safety









WARNING













If the voltage of the power grid fluctuates, resulting in the voltage to exceed 265V, in this case, long-term overvoltage operation may cause damage to the meter. It is recommended to add a fuse with a rated current of 0.5A on the voltage input side of the meter to protect it.

2.4 Safety Symbols And Certification Marks

DANGER

- All labels and warning marks should be visible after the installation. Do not cover, scrawl, or damage any label on the equipment.
- The following descriptions are for reference only.

No.	Symbol	Descriptions
1		Potential risks exist. Wear proper personnel protective equipment before any operations.
2		HIGH VOLTAGE HAZARD Disconnect all incoming power and turn off the product before working on it.
3		High-temperature hazard. Do not touch the product under operation to avoid being burnt.
4		Operate the equipment properly to avoid explosion.
5		Batteries contain flammable materials, beware of fire.
6		The equipment contains corrosive electrolytes. In case of a leak in the equipment, avoid contact the leaked liquid or gas.
7		Delayed discharge. Wait 5 minutes after power off until the components are completely discharged.
8		Install the equipment away from fire sources.

9		Keep the equipment away from children.
10		Operate the equipment properly to avoid explosion.
11		Batteries contain flammable materials, beware of fire.
12		Do not lift the equipment after wiring or when the equipment is working.
13		Do not pour with water.
14		Read through the user manual before any operations.
15		Wear personal protective equipment during installation, operation and maintaining.
16		Do not dispose of the System as household waste. Deal with it in compliance with local laws and regulations, or send it back to the manufacturer.
17		Do not disconnect or plug and unplug the DC connectors during the operation of the equipment.
18		Grounding point.
19		Recycle regeneration mark.
20		CE mark
21		TUV mark

22		RCM mark
----	---	----------

2.5 EU Declaration of Conformity

2.5.1 Equipment With Wireless Communication Modules

GoodWe Technologies Co., Ltd. hereby declares that the equipment with wireless communication modules sold in the European market meets the requirements of the following directives:

- Radio Equipment Directive 2014/53/EU (RED)
- Restrictions of Hazardous Substances Directive 2011/65/EU and (EU) 2015/863 (RoHS)
- Waste Electrical and Electronic Equipment 2012/19/EU
- Registration, Evaluation, Authorization and Restriction of Chemicals (EC) No 1907/2006 (REACH)

2.5.2 Equipment Without Wireless Communication Modules (Except Battery)

GoodWe Technologies Co., Ltd. hereby declares that the equipment without wireless communication modules sold in the European market meets the requirements of the following directives:

- Electromagnetic compatibility Directive 2014/30/EU (EMC)
- Electrical Apparatus Low Voltage Directive 2014/35/EU (LVD)
- Restrictions of Hazardous Substances Directive 2011/65/EU and (EU) 2015/863 (RoHS)
- Waste Electrical and Electronic Equipment 2012/19/EU
- Registration, Evaluation, Authorization and Restriction of Chemicals (EC) No 1907/2006 (REACH)

2.5.3 Battery

GoodWe Technologies Co., Ltd. hereby declares that batteries sold in the European market meets the requirements of the following directives:

- Electromagnetic compatibility Directive 2014/30/EU (EMC)
- Electrical Apparatus Low Voltage Directive 2014/35/EU (LVD)
- Battery Directive 2006/66/EC and Amending Directive 2013/56/EU
- Waste Electrical and Electronic Equipment 2012/19/EU
- Registration, Evaluation, Authorization and Restriction of Chemicals (EC) No 1907/2006 (REACH)

You can download the EU Declaration of Conformity on the official website: <https://en.goodwe.com> .

3 System Introduction

3.1 System Overview

The residential smart inverter solution consists of inverter, battery system, smart meter, smart dongle, etc.. In the PV system, solar energy can be converted to electric energy for household needs. The IoT devices in the system control the electrical equipment by recognizing the overall power consumption situation. So that the power will be managed in a smart way, deciding whether the power is to be used by the loads, stored in batteries, or exported to the grid, etc.

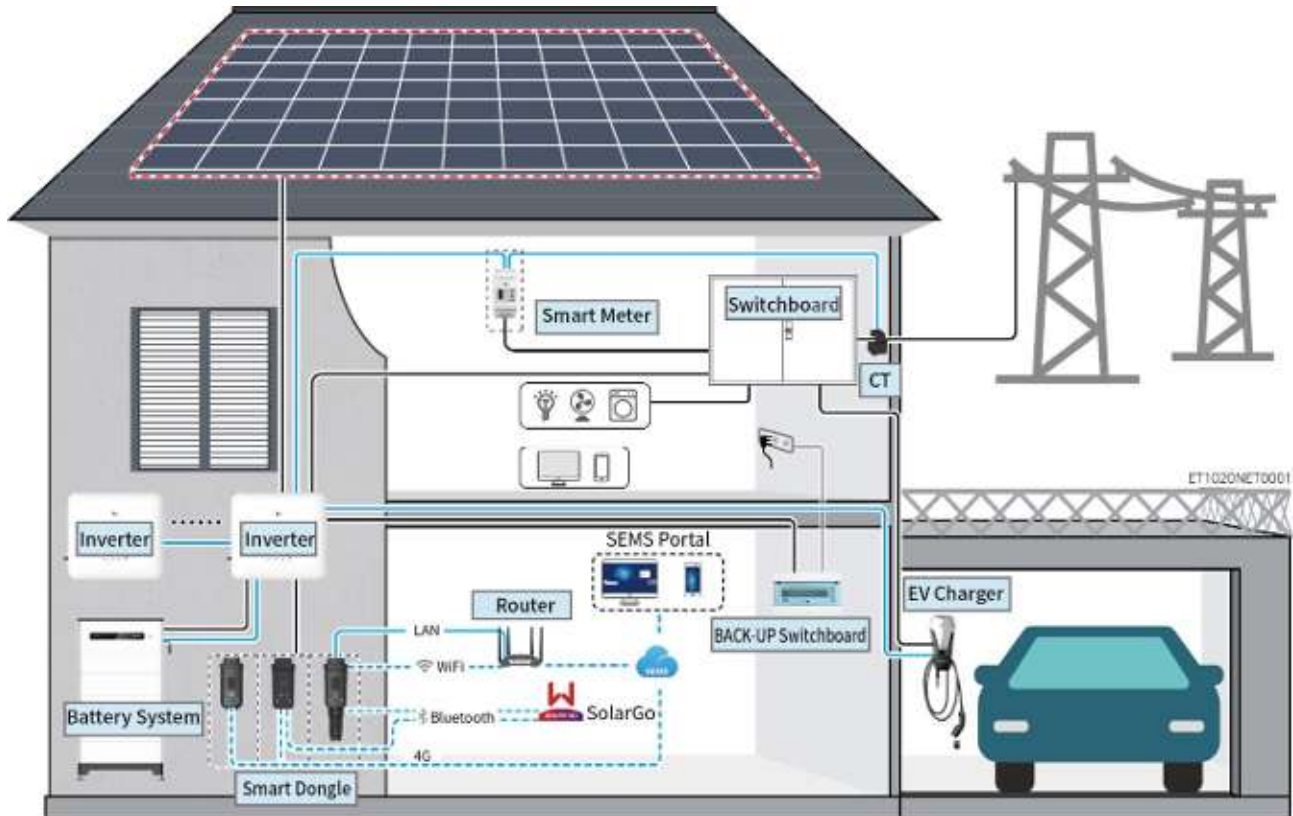

Product Type	Model	Description
Inverter	GW6000-ET-20 GW8000-ET-20 GW9900-ET (only for Australia) GW10K-ET-20 GW12K-ET-20 GW15K-ET-20	A maximum of 4 inverters can be connected in a parallel system. Inverter firmware requirements for parallel connections: <ul style="list-style-type: none"> ● Consistent firmware version ● ARM version: 01.389 or above ● DSP version: 01.15 or above
Battery system	Lynx Home F G2 LX F6.4-H-20 LX F9.6-H-20 LX F12.8-H-20 LX F16.0-H-20 LX F19.2-H-20 LX F22.4-H-20 LX F25.6-H-20 LX F28.8-H-20	Lynx Home F, Lynx Home Plus+ LX F6.6-H LX F9.8-H LX F13.1-H LX F16.4-H Lynx Home D LX D5.0-10
		<ul style="list-style-type: none"> ● The Lynx Home F series battery system cannot be parallel clustered. ● A maximum of 8 battery systems can be clustered in a system. ● Do not mix connect battery systems of different versions.

Smart meter	GM3000 GM330	<ul style="list-style-type: none"> ● GM3000: the CT cannot be replaced. CT ratio: 120A: 40mA. ● GM330: order the CT for GM330 from GoodWe or other suppliers. CT ratio: Na: 5A. <ul style="list-style-type: none"> ➢ nA: CT primary input current, n ranges from 200 to 5000. ➢ 5A: CT Secondary input current.
Smart dongle	WiFi/LAN Kit-20 LS4G Kit-CN 4G Kit-CN 4G Kit-CN-G20 4G Kit-CN-G21 Ezlink3000	<ul style="list-style-type: none"> ● In single inverter system, install the WiFi/LAN Kit-20. ● LS4G Kit-CN, 4G Kit-CN, 4G Kit-CN-G20 or 4G Kit-CN-G21 is only applicable to China and used in single inverter system. ● In parallel scenarios, the EzLink 3000 must be connected to the master inverter. Do not connect any communication module to the slave inverters. ● The firmware version of EzLink should be 04 or above.

3.2 Product Overview

3.2.1 Inverter

Inverters control and optimize the power in PV systems through an integrated energy management system. The power generated in the PV system can be used, stored in the battery, output to the utility grid, etc.

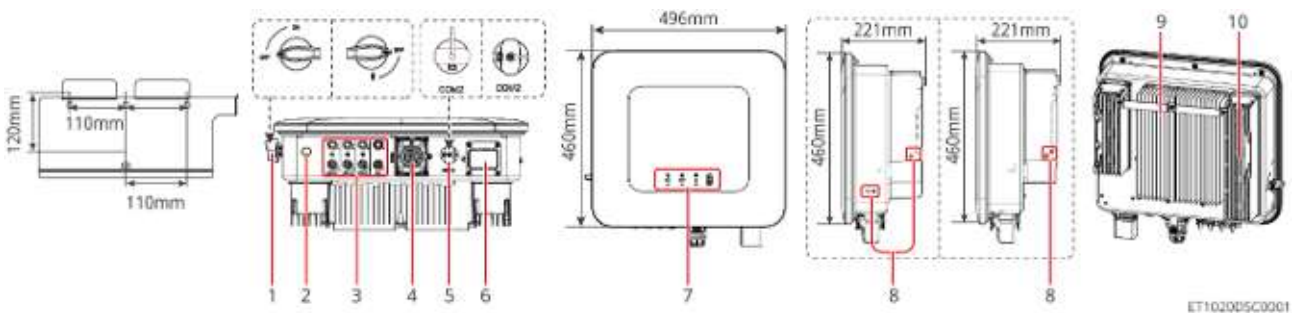

序号	部件	说明
1	DC switch	Control DC input connection or disconnection.
2	Breather valve	-
3	PV input terminal	Connect the PV module DC input cables. <ul style="list-style-type: none"> • GW6000-ET-20and GW8000-ET-20: MPPT x 2 • GW9900-ET-20, GW10K-ET-20, GW12K-ET-20, GW15K-

		ET-20: MPPT x 3
4	Communication port	Connects communication cables and supports communication with CT, electricity meter, DRED, remote shutdown, RCR, EMS, and BMS.
5	Communication module port	<ul style="list-style-type: none"> • Supports communication modules such as 4G, Wi Fi/LAN • Upgrading system software using a USB flash drive.
6	AC output port	Connecting AC Cables.
7	Indicator	Indicates working status of the inverter.
8	PE terminal	Connect the PE cable of the box.
9	Mounting plate	Used to install the inverter.
10	Cooling fin	Cooling fin of the inverter.

No.	Model	Nominal output power	Nominal output voltage	Number of MPPT
1	GW6000-ET-20	6kW	400/380, 3L/N/PE	2
2	GW8000-ET-20	8kW		2
3	GW9900-ET-20 (only for Australia)	9.9kW		3
4	GW10K-ET-20	10kW		3
5	GW12K-ET-20	12kW		3
6	GW15K-ET-20	15kW		3

3.2.2 Battery

The Lynx Home F battery system consists of a power control unit and battery modules. The Lynx Home D battery system consists of integrated BMS and battery modules.

The battery system can store and release electricity according to the requirements of the PV; energy storage system, and the input and output ports of the energy storage system are all; high-voltage direct current.

Lynx Home F, Lynx Home F Plus+

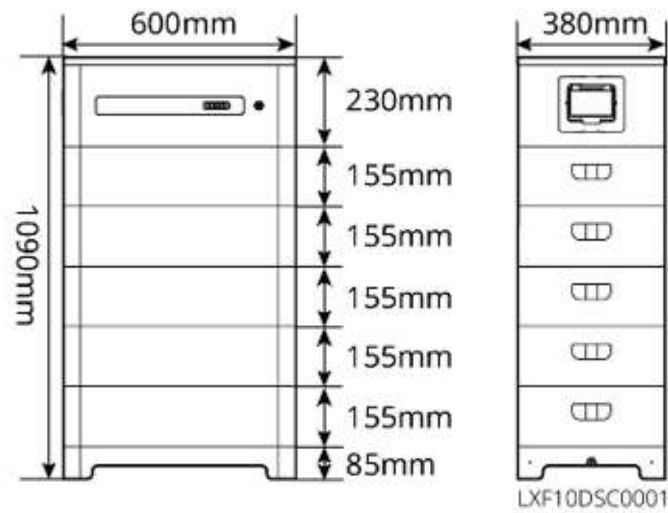

No.	Model	Number of modules	Usable energy (kWh)
1	LX F6.6-H	2	6.55kWh
2	LX F9.8-H	3	9.83kWh
3	LX F13.1-H	4	13.1kWh
4	LX F16.4-H	5	16.38kWh

Lynx Home F G2

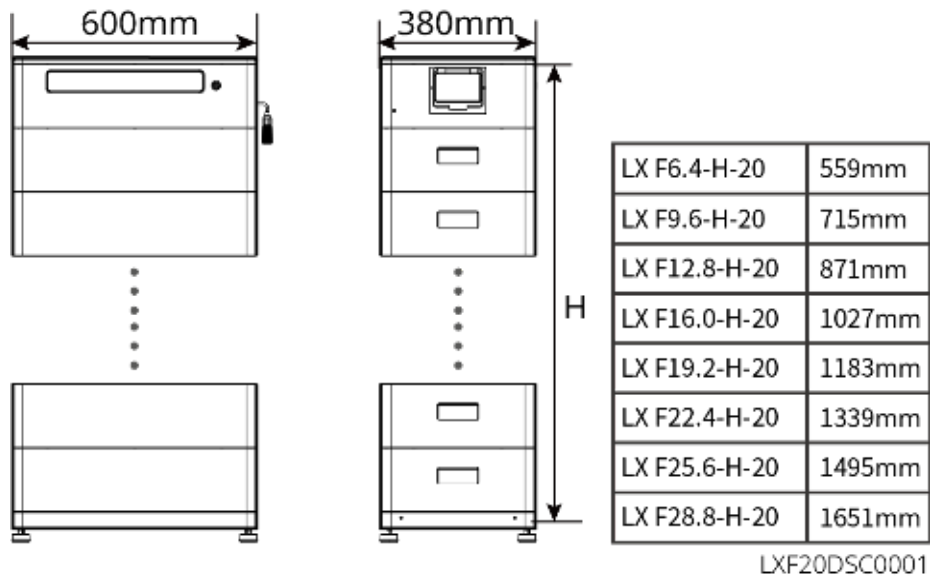

No.	Model	Number of modules
1	LX F6.4-H-20	2
2	LX F9.6-H-20	3
3	LX F12.8-H-20	4
4	LX F16.0-H-20	5

5	LX F19.2-H-20	6
6	LX F22.4-H-20	7
7	LX F25.6-H-20	8
8	LX F28.8-H-20	9

Lynx Home D

NOTICE

Mounting base or wall mounting rack optional.

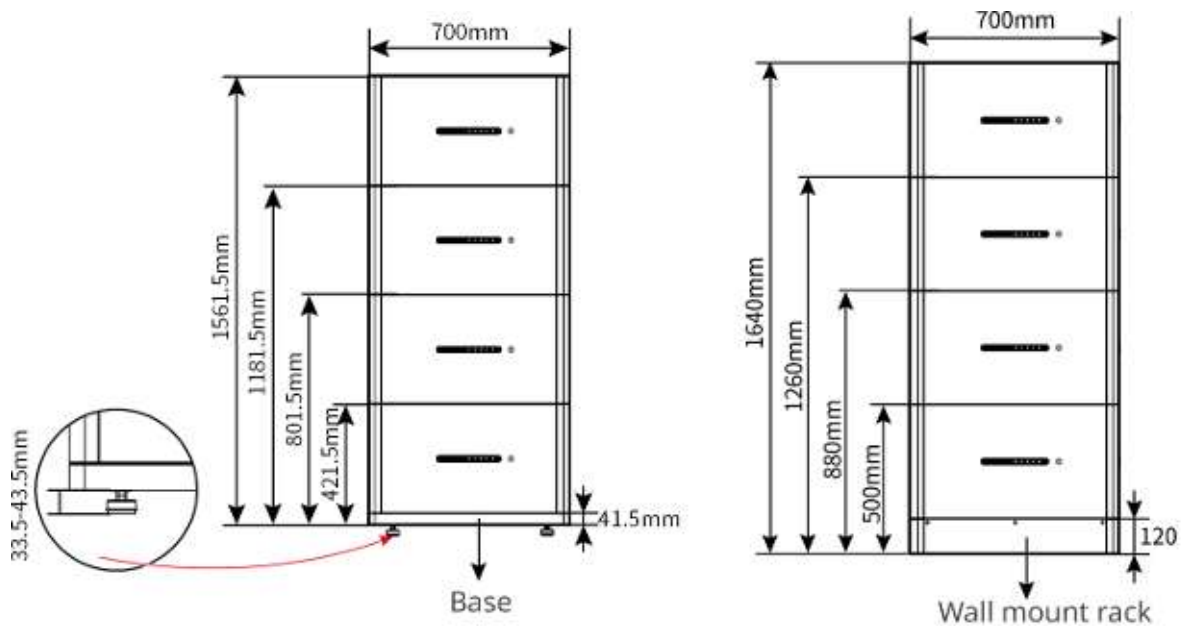

3.2.3 Smart Meter

The smart meter can measure the grid voltage, current, power, frequency, electric energy and other parameters, and transfer the data to the inverter to control the input and output power of the energy storage system.

GM3000&CT

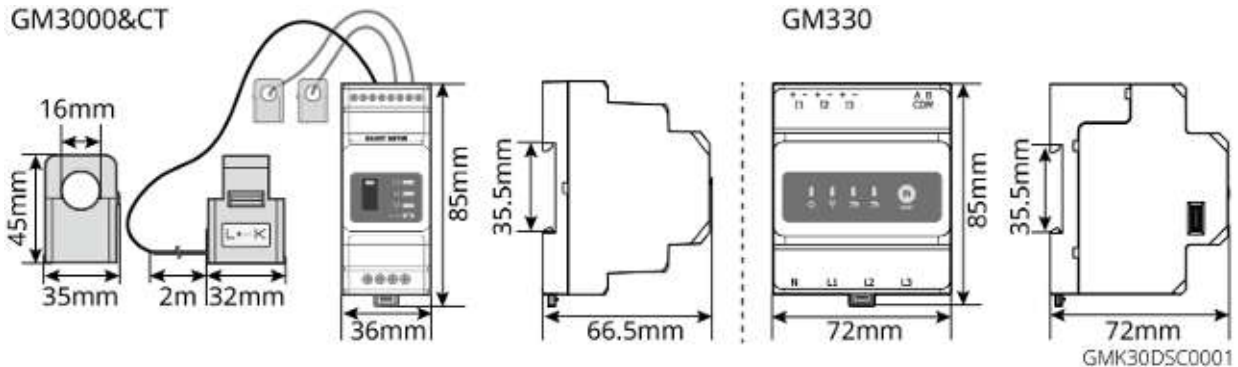

No.	Model	Applicable scenarios
-----	-------	----------------------

1	GM3000	GM3000 and the CT, which cannot be replaced, are included in the inverter package. CT ratio: 120A/40mA.
2	GM330	Order the CT for GM330 from GoodWe or other suppliers. CT ratio: nA/5A. <ul style="list-style-type: none"> ● nA: CT primary input current, n ranges from 200 to 5000. ● 5A: CT Secondary input current.

3.2.4 Smart Dongle

The smart dongle can transmit various power generation data to SEMS Portal, the remote monitoring platform, in real time. And connect to the SolarGo app to complete local equipment commissioning.

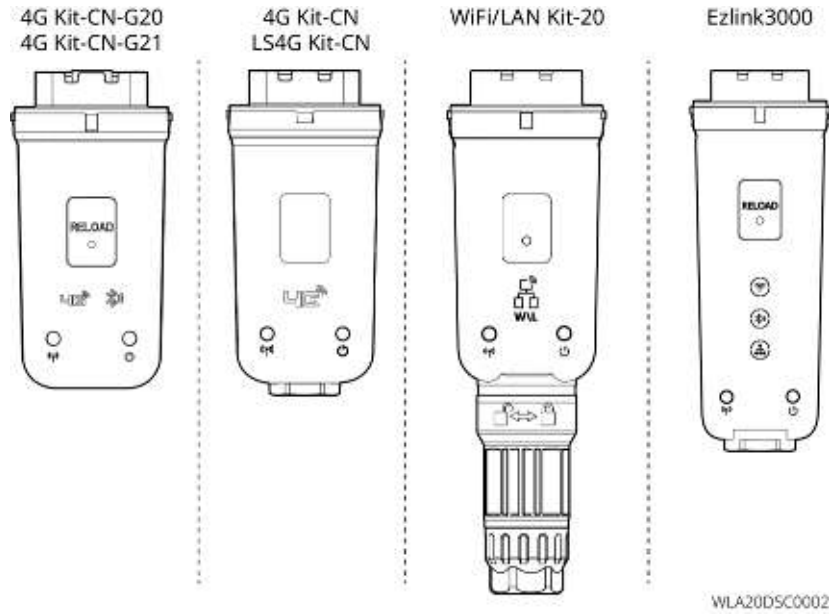

No.	Model	Signal	Applicable scenarios
1	WiFi/LAN Kit-20	WiFi, LAN, bluetooth	Single inverter
2	LS4G Kit-CN 4G Kit-CN	4G	
3	4G Kit-CN-G20 4G Kit-CN-G21	4G、bluetooth 4G、bluetooth、 CNSS	
4	Ezlink3000	WiFi, LAN, bluetooth	Master inverter of the parallel connected inverters

3.3 Supported Grid Types

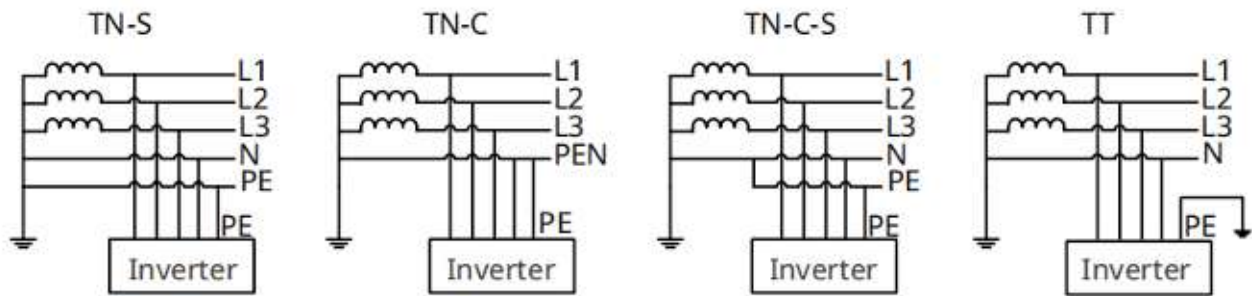

3.4 System Working Mode

Self-use Mode

- Self-use mode is the basic working mode of the system.
- When the power generated in the PV system is sufficient, it will supply the loads in priority. The excess power will charge the batteries first, then the remaining power will be sold to the utility grid. When the power generated in the PV system is insufficient, the battery will supply the loads in priority. If the battery power is insufficient, the load will be powered by the utility grid.

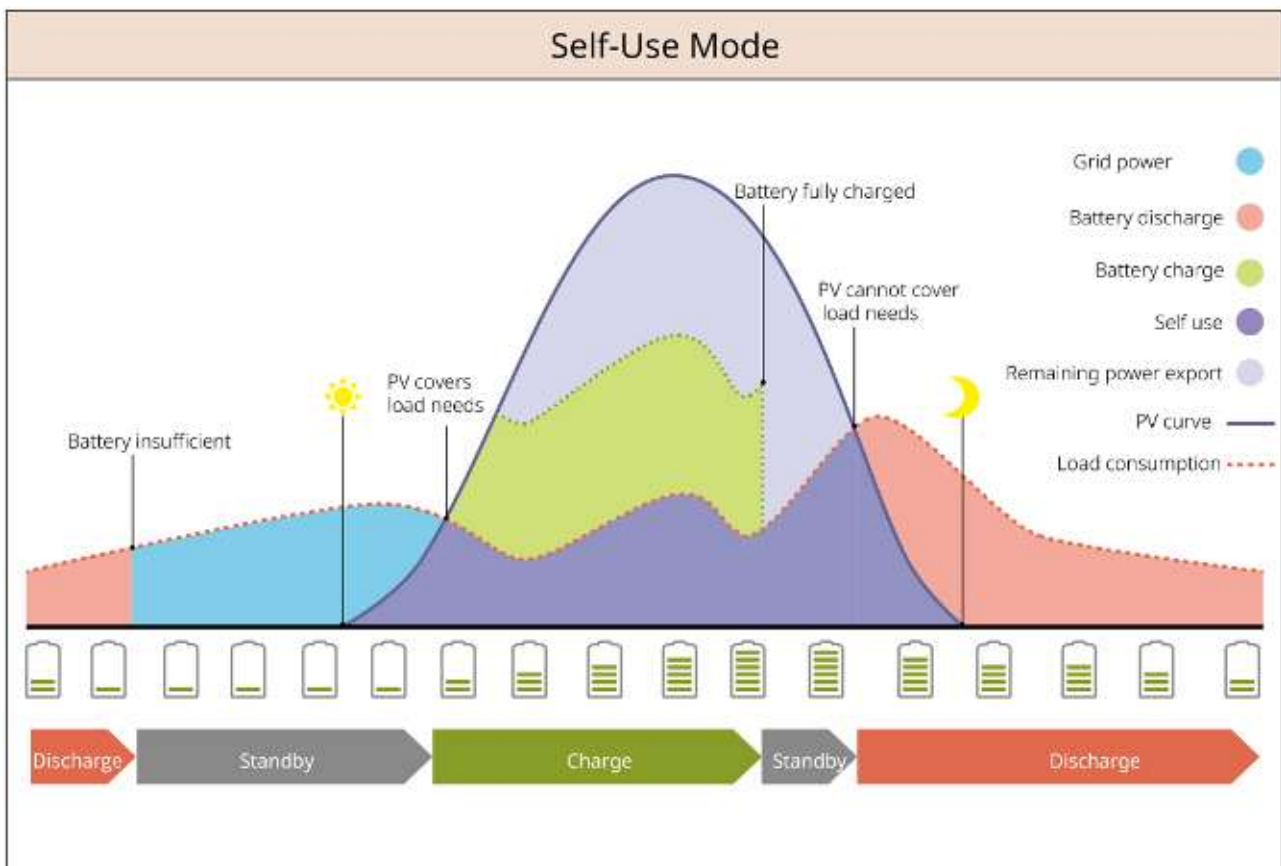

Back-up mode

- The back-up mode is mainly applied to the scenario where the grid is unstable.
- When the grid is disconnected, the inverter turns to off-grid mode and the battery will supply power to the BACK-UP loads; when the grid is restored, the inverter switches to grid-tied mode.
- The battery will be charged to preset SOC protection value by utility grid or PV when the system is running on-grid. So that the battery SOC is sufficient to maintain normal working when the system is off-grid. The purchase of electricity from the power grid to charge the battery must comply with local laws

and regulations.

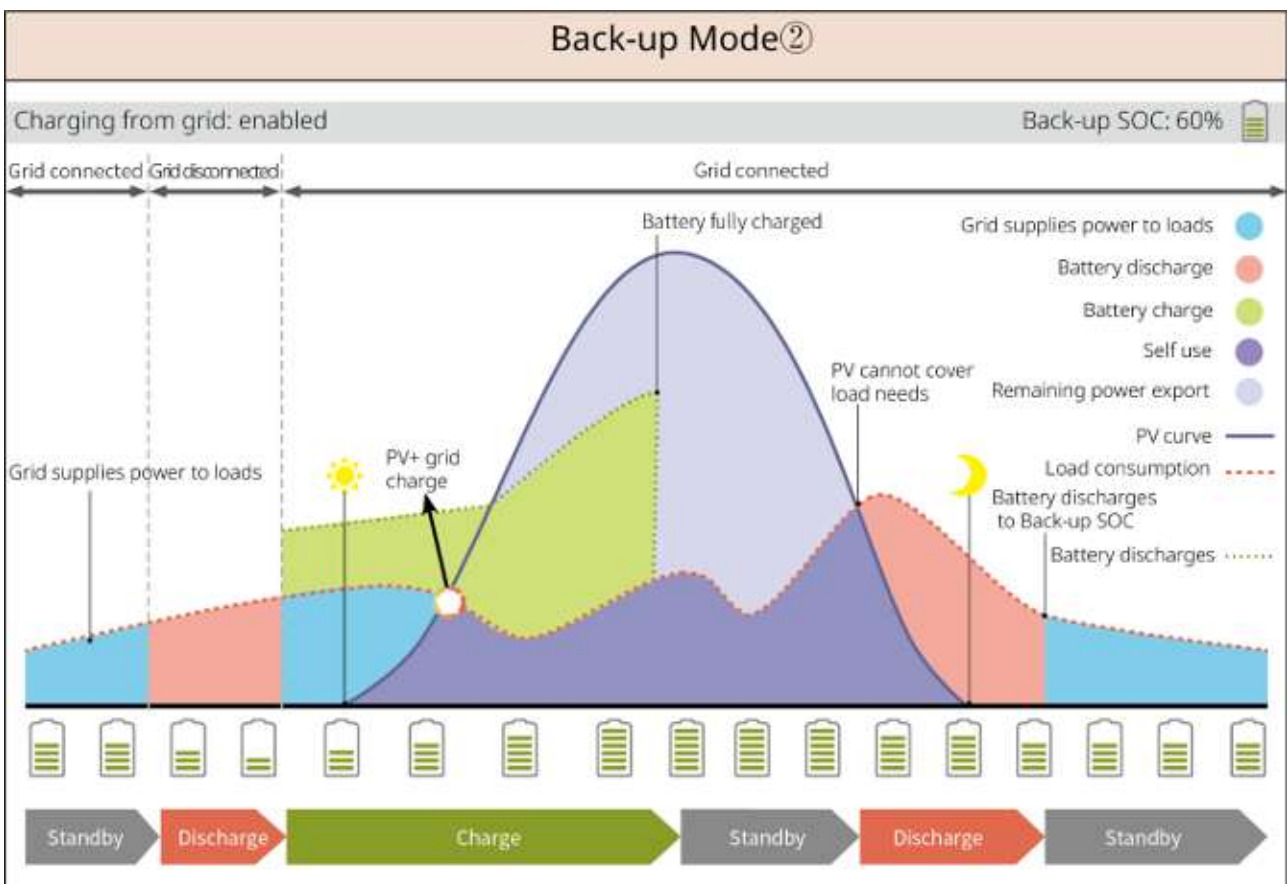
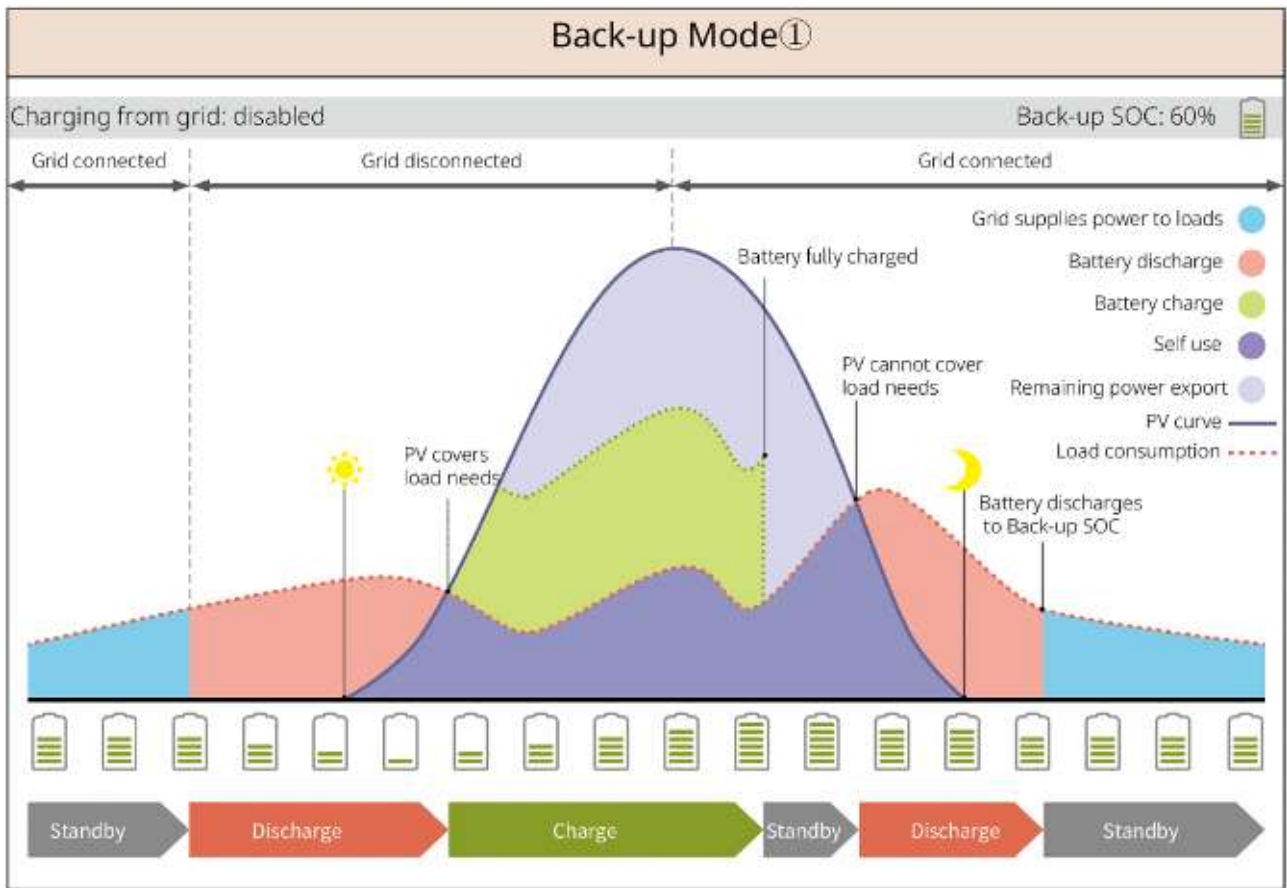

SLG00NET0003

Economic mode

It is recommended to use economic mode in scenarios when the peak-valley electricity price varies a lot. Select economic mode only when it meets the local laws and regulations.

For example, set the battery to charge mode during Vally period to charge battery with grid power. And set the battery to discharge mode during Peak period to power the load with the battery.

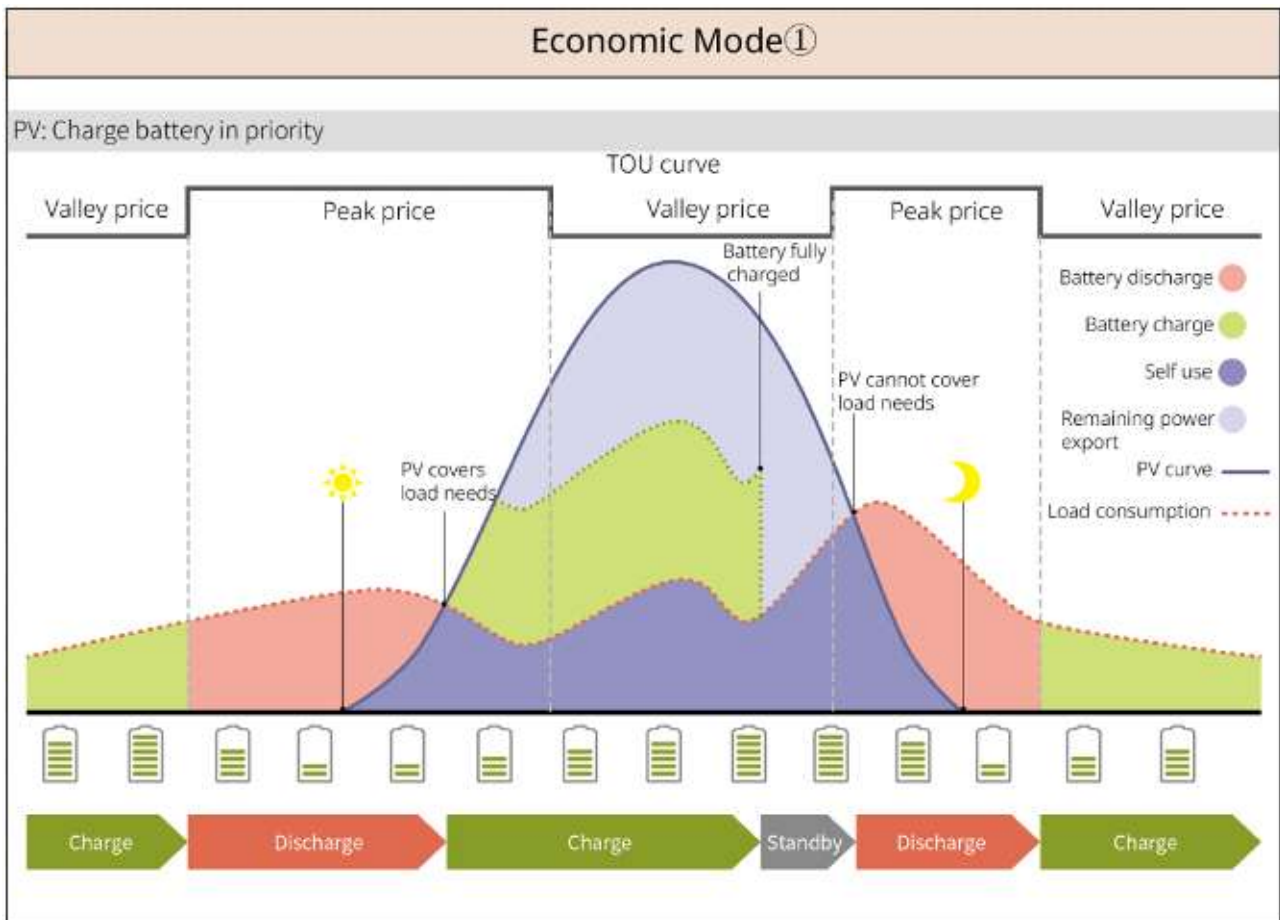

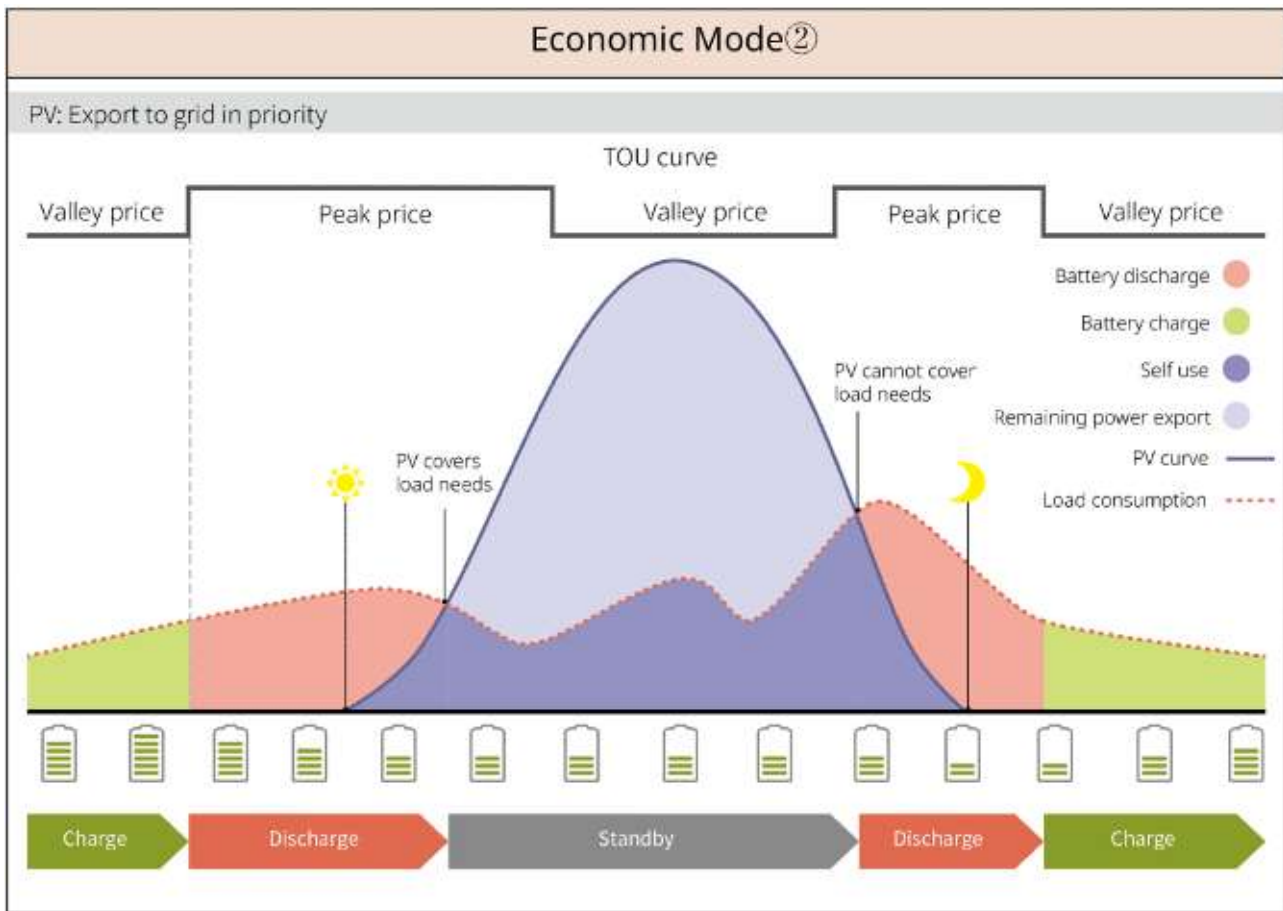

Smart charging mode

- In some countries/regions, the PV power feed into the utility grid is limited.
- Set peak limit power, charge the battery using the surplus power when the PV power exceeds the peak limit power. Or set charging time, during the charging time, the PV power can be used to charge the battery.

Smart Charging①

PV > Peak Limit

Switch to Charge: enabled/disabled

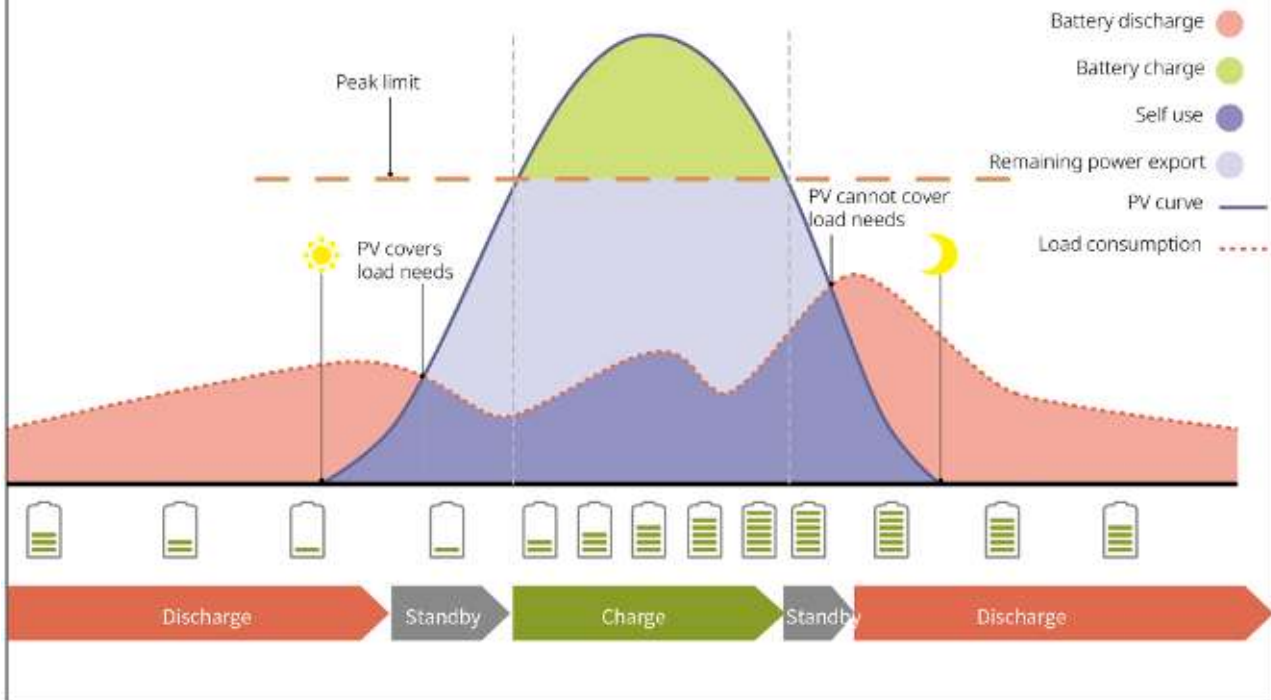

Smart Charging②

PV < Peak Limit

Switch to Charge: enabled

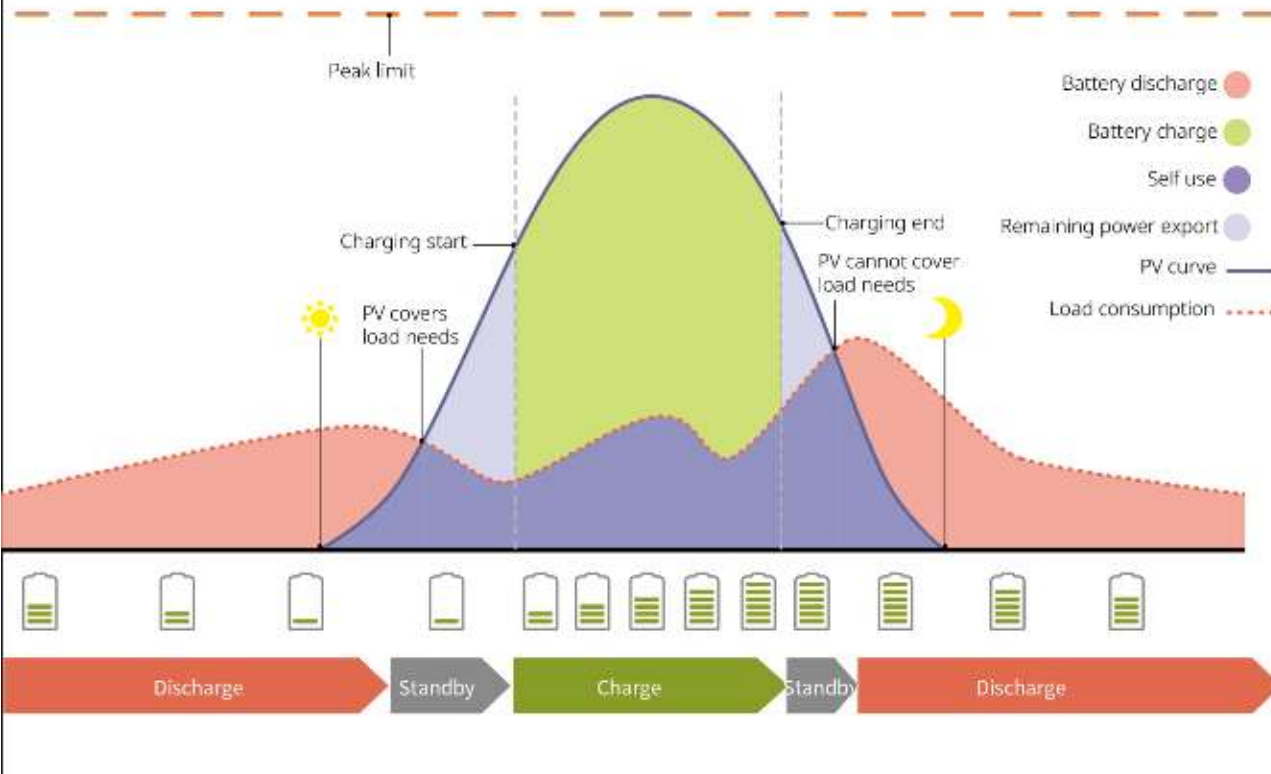

SLG00NET0007

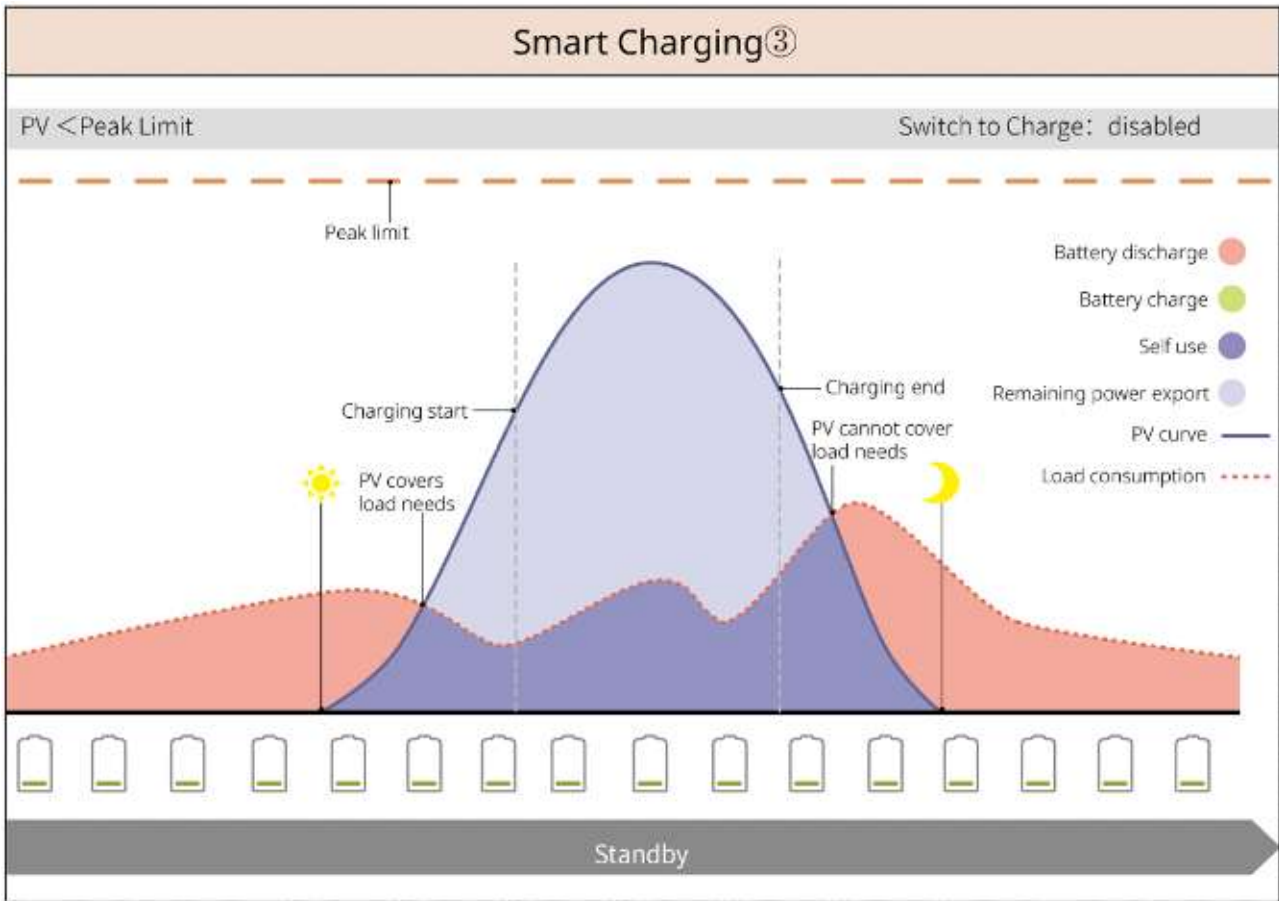

Peakshaving Mode

- Peakshaving mode is mainly applicable to industrial and commercial scenarios.
- When the total power consumption of the loads exceeds the peak shaving limit, the battery discharges to reduce the power consumption exceeds the peak shaving limit.
- If the SOC of the two connected battery systems are lower than the Reserved SOC for Peakshaving, the system will import power from the utility grid according to the set time period, load power, and Import Power Limit. If the SOC of one battery system is lower than the Reserved SOC for Peakshaving, the system will import power from the utility grid according to the load power, and Import Power Limit.

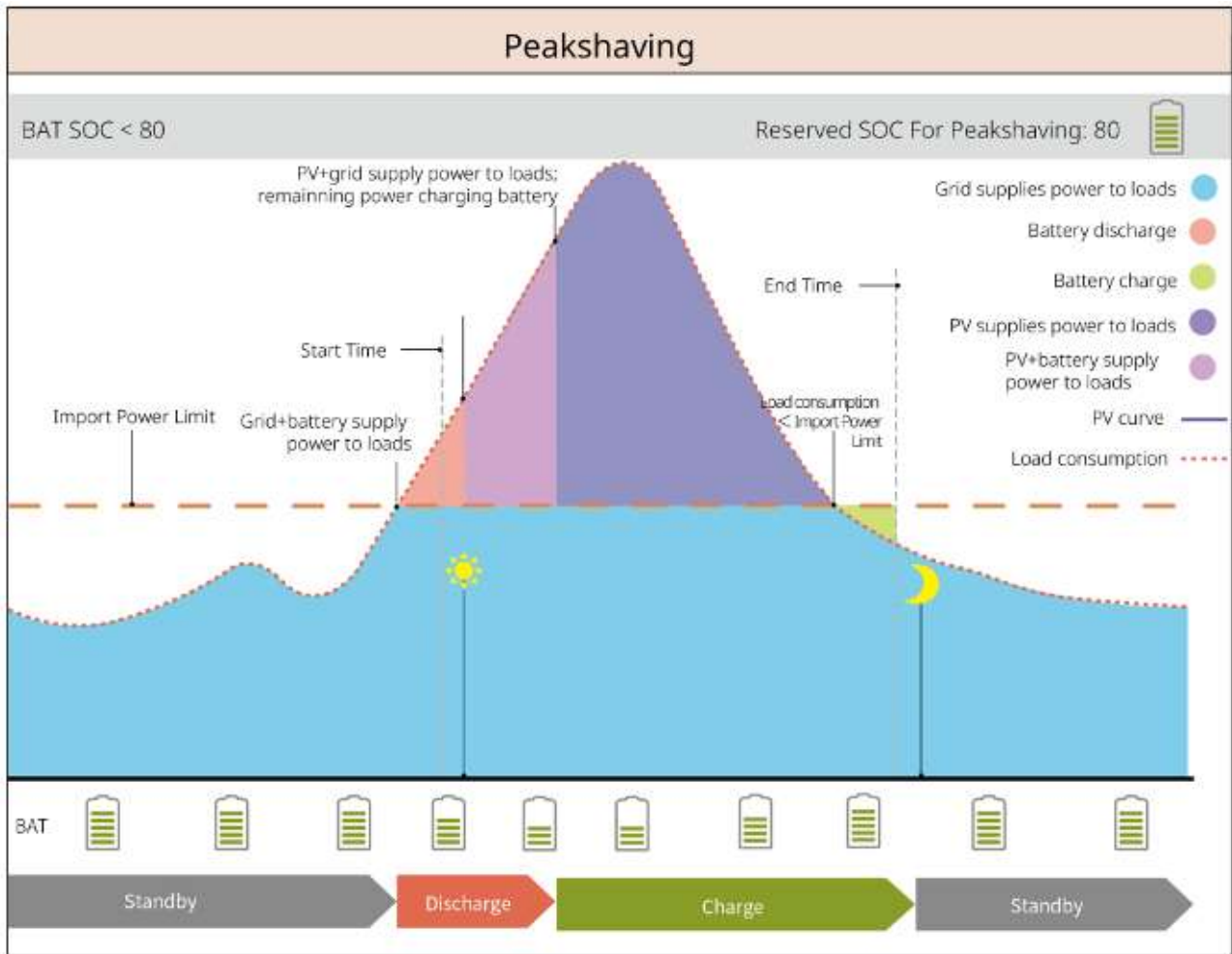

3.5 Features

Three-phase Unbalanced Output

Both the ON-GRID port and the BACK-UP port of the inverter support the three-phase unbalanced output, and each phase can connect loads of different power. The maximum output power per phase of different models is shown in the following table:

No.	Model	Max. Output Power per Phase
1	GW6000-ET-20	3kW
2	GW8000-ET-20	4kW
3	GW9900-ET-20 (only for Australia)	5kW
4	GW10K-ET-20	5kW
5	GW12K-ET-20	5kW
6	GW15K-ET-20	5kW

4 Check and Storage

4.1 Check Before Receiving

Check the following items before receiving the product.

1. Check the outer packing box for damage, such as holes, cracks, deformation, and other signs of equipment damage. Do not unpack the package and contact the supplier as soon as possible if any damage is found.
2. Check the product model. If the model is not what you requested, do not unpack the product and contact the supplier.

4.2 Package Content











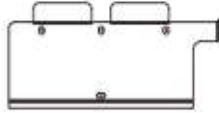

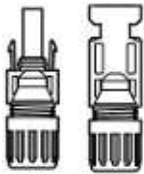



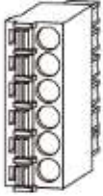
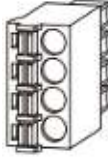
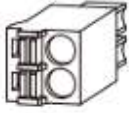

WARNING

Check the deliverables for correct model, complete contents, and intact appearance. Contact the supplier as soon as possible if any damage is found.

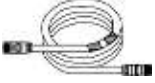
After removing the pack, do not place the deliverables in any rough, uneven or sharp placed to avoid paint loss.

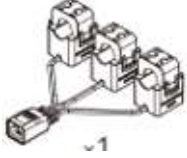
4.2.1 Package of the Inverter (ET 6-15kW)

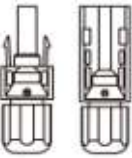
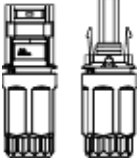
Parts	Quantity	Parts	Quantity
	Inverter x 1		Mounting plate x 1
	Screws for mounting plate x 1		PV connector GW6000-ET-20, GW8000-ET-20: 2 GW9900-ET-20, GW10K-ET-20, GW12K-ET-20, GW15K-ET-20: 3
 or 	Connection tool x 2		Documents x 1















	6PIN terminal x 1		4PIN terminal x 3
	2PIN terminal x 1		AC terminal x 12
	PE terminal x 1		Tubular terminal x 20
	AC cover x 1		BMS/Meter communication cable x 1
	Expansion bolt x 4		CT x 1
	Smart dongle x 1		Screwdriver x 1
 Battery connector	(Optional) Battery connector x 2		
 Battery connector  Crimping terminal	(Optional) Battery connector x 1 Crimping terminal x 8		

4.2.2 Package of the Battery (Lynx Home F)

4.2.2.1 Lynx Home F or Lynx Home F Plus+

- Power control unit

Parts	Quantity	Parts	Quantity
-------	----------	-------	----------

	PCU x 1		Base x 1
	DC connector <ul style="list-style-type: none"> ● Lynx Home F x1 ● Lynx Home F Plus+ x 2 		Expansion bolt x 4
Adjustable feet 	<ul style="list-style-type: none"> ● Adjustable feet: only for Lynx home F Plus+ ● Included bracket quantity when selecting adjustable feet: <ul style="list-style-type: none"> ○ Adjustable feet: 4pcs ○ Locking bracket (match adjustable feet): 2pcs ○ Normal locking bracket: 2pcs ● Included bracket quantity when adjustable feet is not selected: <ul style="list-style-type: none"> ○ Normal locking bracket: 4pcs 		
Locking bracket (match adjustable feet) 			
Normal locking bracket 			
	M5*12 screw x 4		M5 hexagon screw x 2
	M6 screw x 2		Grounding terminal x 2
	Protection cover x 1		Documents x 1
	Terminal resistor x 1	-	-



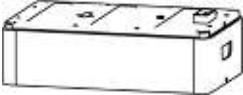













● **Battery module**

Parts	Quantity
	Battery module x 1

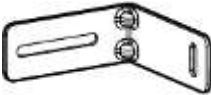
4.2.2.2 Lynx Home F G2

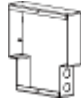
● **Power control unit**

Parts	Quantity	Parts	Quantity
-------	----------	-------	----------

	PCU x 1		Base x 1
	DC Connector • Positive x 2 • Negative x 2		Expansion bolt x 8
	Adjustable feet x 4		M5*12 screws x N N: Quantity depends on product configuration: <ul style="list-style-type: none"> • M5*12 screws x 8 • M5*12 screws x10 • M5*12 screws x 11 • M5*12 screws x 13 • M5*12 screws x 12
	M6 screw x N N: Quantity depends on product configuration: <ul style="list-style-type: none"> • M6 screw x 2 • M6 screw x 0 		PE terminal x 2
	Documents x 1		(Optional) Cover plate x 1
	Locking bracket x 8	 Junction box cover  Junction box	(Optional) Junction box x 1 , Junction box cover x 1 ,
	Waterproof plug for DC connector (6mm ²) x 4	 	Waterproof plug for DC connector (16mm ²) x 4

● **Battery module**







Parts	Quantity
	Battery module x 1

4.2.3 Package of the Battery (Lynx Home D)

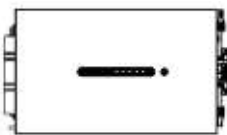

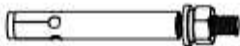

NOTICE
The battery system needs to be mounted on a base or hanger. Please select the base or the hanger

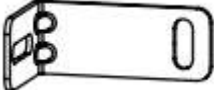

according to the installation conditions. The specific delivery content is subject to the actual selection.

● **Battery**





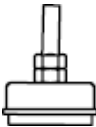
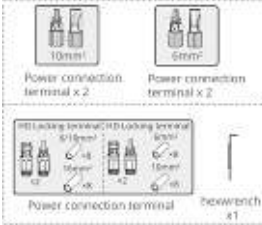



Parts	Quantity	Parts	Quantity
	Battery x 1		Battery's left protective cover x 1
	M6 screws x 2		Battery's right protective cover x 1
	M5 screws <ul style="list-style-type: none"> ● Fixing bracket between batteries delivered as accessories: M5 screws x4 ● Fixing bracket between batteries installed in the battery: M5 screws x2 		M6 expansion bolt x 2
	Fixing bracket between batteries <ul style="list-style-type: none"> ● Fixing bracket between batteries delivered as accessories: Fixing bracket between batteries x2 ● Fixing bracket between batteries installed in the battery: Fixing bracket between batteries x0 		Communication cable between batteries x 1
	Locking bracket x 2		



● **(Optional) Base**

Parts	Quantity	Parts	Quantity
	Base x 1		M5 Screws x 2
	Documents x 1		Fixing bracket between base and battery x 2

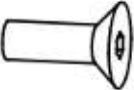
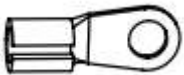



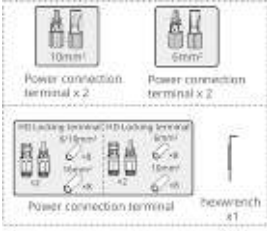

	<p>Grounding terminal x 1</p>		<p>Adjustable feet x N The quantity of adjustable feet is subject to actual shipment. If there are no adjustable feet in the actual delivery and you need use them, please contact the dealer or after-sales service to obtain them.</p>
	<ul style="list-style-type: none"> ● Power connector ● (Optional)hexwrench <p>The hexwrench is shipped together with the battery DC terminal labeled with HD Locking terminal on the ziplock bag.</p>		<p>Terminal resistor x 1</p>
	<p>Fastening tool for power connector</p>	<p>-</p>	<p>-</p>

● (Optional) Mounting rack



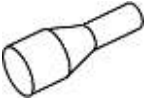



Parts	Quantity	Parts	Quantity
	<p>Wall mounting rack x 1</p>		<p>Front protective cover x 1</p>
	<p>Left protective cover x 1</p>		<p>Right protective cover x 1</p>
	<p>Fixing bracket between rack and battery x 2</p>		<p>M5 screws x 2</p>
	<p>M12 expansion bolt x 4</p>		<p>M4 screws x 5</p>
	<p>Grounding terminal x 1</p>		<p>Terminal resistor x 1</p>

 <p>10mm² Power connection terminal x 2 6mm² Power connection terminal x 2</p> <p>HD Locking terminal 0.15mm² x 4 HD Locking terminal 0.25mm² x 2 HD Locking terminal 0.5mm² x 2 HD Locking terminal 1.0mm² x 2 HD Locking terminal 1.5mm² x 2 HD Locking terminal 2.0mm² x 2</p> <p>Power connection terminal hexwrench x 1</p>	<ul style="list-style-type: none"> ● Power connector ● (Optional)hexwrench <p>The hexwrench is shipped together with the battery DC terminal labeled with HD Locking terminal on the ziplock bag.</p>	 <p>x 1 x 1 x 2</p>	<p>Fastening tool for power connector</p>
	<p>Documents x 1</p>	<p>-</p>	<p>-</p>

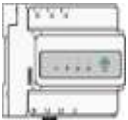
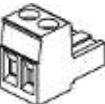

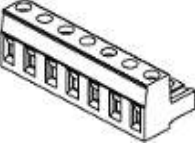
4.2.4 Smart Meter (GM3000)

Parts	Quantity	Parts	Quantity
	<p>Smart meter and CT x 1</p>		<p>2PIN-RJ45 adapter cable x 1</p>
	<p>Tubular terminal x 3</p>		<p>USB plug x 1</p>
	<p>Screws driver x 1</p>		<p>Documents x 1</p>





4.2.5 Smart Meter (GM330)

Parts	Description	Parts	Description
	<p>Smart meter and CT x 1</p>		<p>2PIN terminal x 1</p>
	<p>PIN terminal x 6</p>		<p>7PIN terminal x 1</p>
	<p>Screw driver x 1</p>		<p>6PIN terminal x 1</p>
	<p>2PIN-RJ45 adapter cable x 1</p>		<p>Documents x 1</p>

4.2.6 Smart Dongle (WiFi/ LAN Kit-20)

Parts	Description	Parts	Description
	Smart dongle x 1		Documents x 1

4.2.7 Smart Dongle (Ezlink3000)

Parts	Description	Parts	Description
	Smart dongle x 1		LAN cable connector x 1
	Documents x1		Unlock tool x 1 Remove the module using the removing tool if it is included. If the tool is not provided, remove the module by pressing the unlock button on the module.

4.2.8 Smart Dongle (LS4G Kit-CN&4G Kit-CN)

部件	说明	部件	说明
	4G Smart dongle x 1	-	-

4.2.9 Smart Dongle (4G Kit-CN-G20 & 4G Kit-CN-G21)

Parts	Description	Parts	Description
	Smart dongle x 1		Documents x 1

4.3 Storage

If the equipment is not to be installed or used immediately, please ensure that the storage environment meets the following requirements: If the equipment has been long term stored, it should be checked by

professionals before being put into use.

1. If the inverter has been stored for more than two years or has not been in operation for more than six months after installation, it is recommended to be inspected and tested by professionals before being put into use.
2. To ensure good electrical performance of the internal electronic components of the inverter, it is recommended to power it on every 6 months during storage. If it has not been powered on for more than 6 months, it is recommended to be inspected and tested by professionals before being put into use.
3. In order to protect the performance and life of the battery, it is recommended to avoid unused storage for a long period of time. Prolonged storage may cause deep discharging of the battery, resulting in irreversible chemical loss, leading to capacity degradation or even complete failure, timely use is recommended. If the battery is to be stored for a long period of time, please maintain it as follows:

Specific Model	Battery storage initial SOC range	Recommended Storage Temperature	Charing and Discharging Maintaining Period ^[1]	Battery Maintaining Method ^[2]
LX F6.6-H	30%~50%	0~35°C	-20~0°C, ≤1 month 0~35°C, ≤6 months 35~45°C, ≤1 months	Contact the dealer or the after-sales service for maintenance methods.
LX F9.8-H				
LX F13.1-H				
LX F16.4-H				
LX F9.6-H-20	30%~40%	0~35°C	-20~0°C, ≤1 month 0~35°C, ≤6 months 35~45°C, ≤1 months	
LX F12.8-H-20				
LX F16.0-H-20				
LX F19.2-H-20				
LX F22.4-H-20				
LX F25.6-H-20				
LX F28.8-H-20				
LX D5.0-10	30%~40%	0~35°C	-20~35°C, ≤12 months 35~+45°C, ≤6 months	

NOTICE

[1] The storage time starts from the SN date on the outer packaging of the battery and requires charging and discharging maintenance after the storage cycle is exceeded. (Battery maintenance time = SN date + charging/discharging maintenance cycle). To view the SN date, please refer to [the meaning of SN code](#).

[2] After passing the charging/discharging maintenance, if there is a Maintaining Label attached to the outer box, then please update the maintenance information on the Maintaining Label. if there is no Maintaining Label, please record the maintenance time and SOC of the batteries and keep the data to facilitate the keeping of maintenance records.

Packing requirements:

Do not unpack the outer package or throw the desiccant away.

Installation environment requirements :

1. Place the equipment in a cool place where away from direct sunlight.
2. Store the equipment in a clean place. Make sure the temperature and humidity are appropriate and no condensation. Do not install the equipment if the ports or terminals are condensed.
3. Keep the equipment away from flammable, explosive, and corrosive matters.

Stacking requirements:

1. The height and direction of the stacking inverter should follow the instructions on the packing box.
2. The inverter must be stacked with caution to prevent them from falling.

5 Installation

⚠ DANGER

Install and connect the equipment using the deliverables included in the package. Otherwise, the manufacturer shall not be liable for the damage.

5.1 System Installation and Commissioning Procedure

Steps	1 Installation	2 PE	3 PV	4 Battery	5 AC	6 COM	7 Communication module	
Inverter								
Tools								
Steps	1 Installation				2 PE	3 Battery		4 COM
Battery								
Tools								
Steps	1 Installation		2 Cable Connections		3 Power	4 Commissioning		
Smart meter								

5.2 Installation Requirements

5.2.1 Installation Environment Requirements

NOTICE

Lynx home D:

- The main source of battery operation sound comes from the active cooling system, specifically the axial flow cooling fan with hydrodynamically optimized design.
- When the battery produces $\leq 35\text{dB (A)}$ regular airflow sound, it characterizes the cooling system is in normal working condition and will not have any impact on the electrical performance, structural safety and life of the equipment. If you are sensitive to the noise, please choose the installation location reasonably.

1. Do not install the equipment in a place near flammable, explosive, or corrosive materials.
2. The temperature and humidity at the installation site should be within the appropriate range.
3. Do not install the equipment in a place that is easy to touch, especially within children's reach.
4. 60°C high temperature exists when the equipment is working. Do not touch the surface to avoid burning.
5. Install the equipment in a sheltered place to avoid direct sunlight, rain, and snow. Build a sunshade if it is needed.
6. The inverter output power may decrease due to direct sunlight or high temperature.
7. The place to install the equipment shall be well-ventilated for heat radiation and large enough for operations.
8. Check the protection rating of the equipment and ensure that the installation environment meets the requirements. The inverter, battery system, and smart dongle can be installed both indoors or outdoors. But the smart meter can only be installed indoors.
9. Install the equipment at a height that is convenient for operation and maintenance, electrical connections, and checking indicators and labels.
10. The altitude to install the equipment shall be lower than the maximum working altitude of the system.
11. Consult the manufacturer before installing the equipment outdoors in salt affected areas. A salt affected area refers to the region within 500 meters offshore, and will be related to the sea wind, precipitation and topography.
12. Install the equipment away from electromagnetic interference. If there is any radio or wireless communication equipment below 30MHz near the equipment, you have to:
 - Inverter: add a multi-turn winding ferrite core at the AC output cable of the inverter, or add a low-pass EMI filter.
 - Other equipments: the distance between the equipment and the wireless EMI equipment should be more than 30m.
13. The DC and communication cables between the battery and inverter should be less than 3 meters. Please ensure that the installation distance between the inverter and the battery meets the cable length requirements.

NOTICE

If installed in an environment below 0°C, the battery will not be able to continue charging to restore energy after being discharged, resulting in undervoltage protection.

- Lynx home F、Lynx home F Plus+、Lynx home F G2: Charging temperature range: 0<T<50°C; Discharging temperature range: -20<T<50°C
- Lynx home D: Charging temperature range: 0<T<53°C; Discharging temperature range: -20<T<53°C

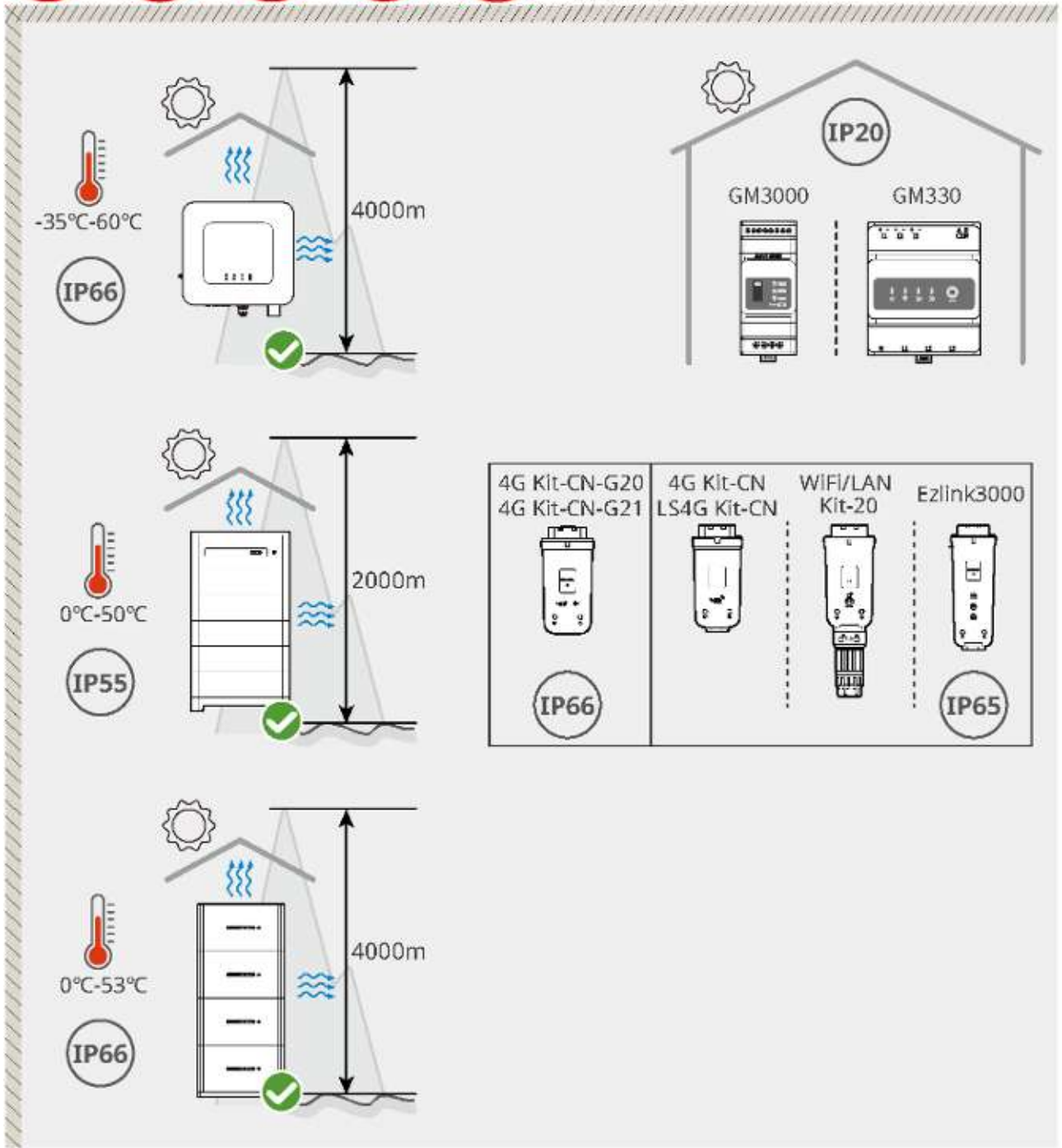

ET1020INT0003

5.2.2 Installation Space Requirements

Reserve enough space for operations and heat dissipation when installing the system.

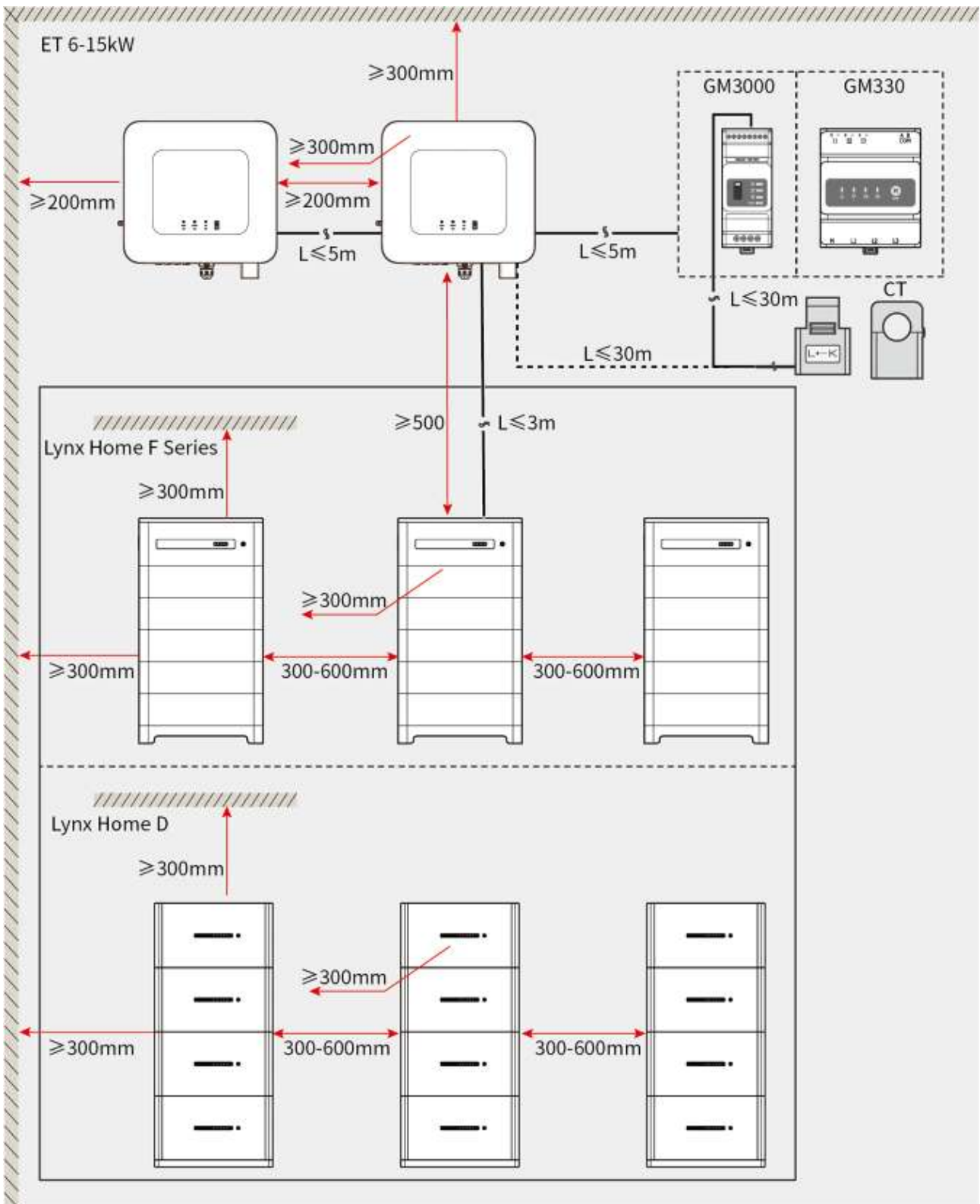

ET1020DSC0002

5.2.3 Tool Requirements

NOTICE



The following tools are recommended when installing the equipment. Use other auxiliary tools on site if necessary.

Installation Tools

Tool	Description	Tool	Description
	Diagonal pliers		RJ45 crimping tool
	Wire stripper		YQK-70 hydraulic pliers
	VXC9 hydraulic pliers		Level
	Adjustable wrench		PV connector tool PV-CZM-61100
	Hammer drill (Φ8mm)		Torque wrench M5/M6/M8
	Rubber hammer		Socket wrench set
	Marker		Multimeter Range≤1100V
	Heat shrink tube		Heat gun
	Cable tie		Vacuum cleaner

Personal Protective Equipment

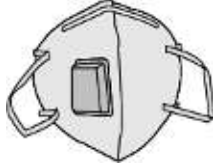
Tool	Description	Tool	Description
------	-------------	------	-------------

	Insulation gloves and safety gloves		Dust mask
	Goggles		Safety shoes

5.2.4 Transportation Requirements

WARNING

- Operations such as transportation, turnover, installation and so on must meet the requirements of local laws and regulations.
- Move the equipment to the site before installation. Follow the instructions below to avoid personal injury or equipment damage.
 1. Consider the weight of the equipment before moving it. Assign enough personnel to move the equipment to avoid personal injury.
 2. Wear safety gloves to avoid personal injury.
 3. Keep balance to avoid falling down when moving the equipment.

5.3 Installing the Inverter

CAUTION

- Avoid the water pipes and cables buried in the wall when drilling holes.
- Wear goggles and a dust mask to prevent the dust from being inhaled or contacting eyes when drilling holes.
- Make sure the inverter is firmly installed in case of falling down.

Step 1 Put the plate on the wall horizontally and mark positions for drilling holes.

Step 2 Drill holes with the hammer drill.

Step 3 Use the expansion bolts to fix the inverter on the wall.

Step 4 Secure the DC switch with the DC switch lock, ensuring that the DC switch is OFF during installation. Install the inverter on the mounting plate. (Optional) Australia only. The DC switch lock of appropriate size should be prepared by customers. Tighten the nuts to secure the mounting plate and the inverter.

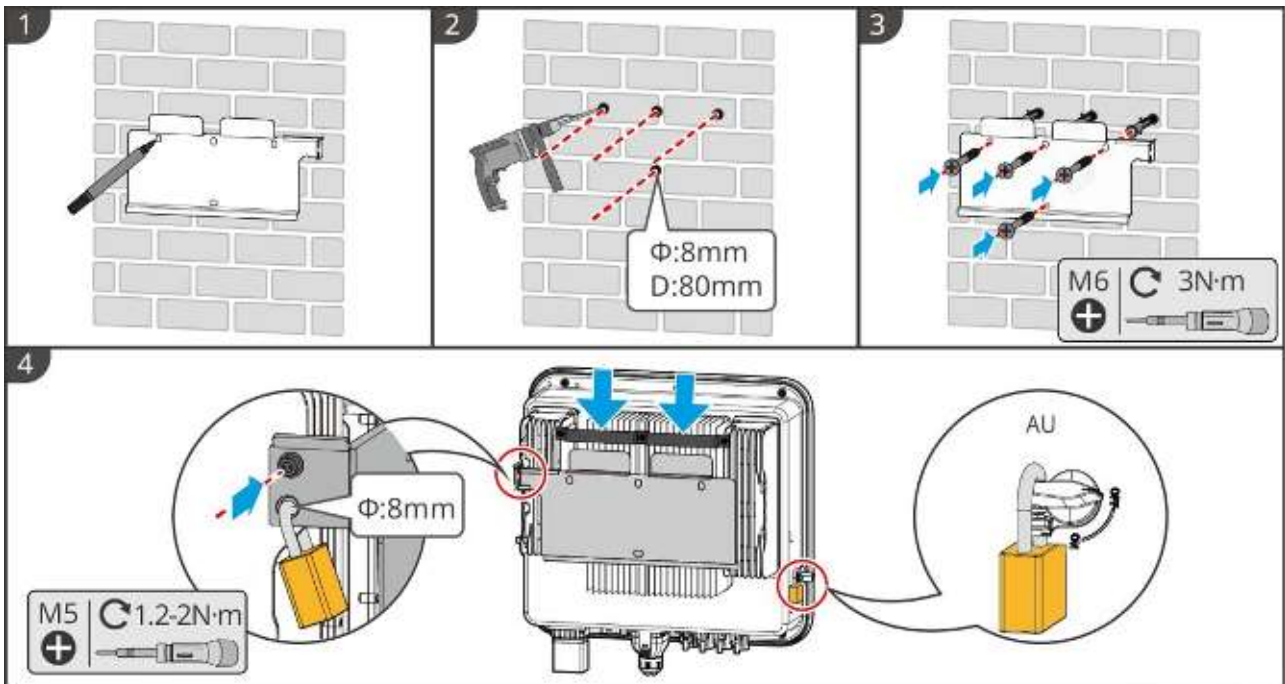

ET1020INT0002

5.4 Installing the Battery System

5.4.1 Installing Lynx Home F

WARNING

- Ensure that the PCU is installed above the battery modules. Do not install any battery modules above the PCU.
- Ensure that the battery system is installed vertically and securely. Align the installation holes of the battery base, battery modules, and PCU. Ensure that the locking bracket clings to the ground, wall or battery system.
- Cover the equipment with a cardboard to prevent foreign matters when drilling holes. Otherwise, the system may be damaged.
- Remove the protective cover on the connection part of the battery system before installation.
- Remove the cover of the battery module's connection port before installing the battery system.

Step 1 Install the locking bracket to the base.

Step 2 Place the base cling to the wall and mark the drilling positions. Then remove the base.

Step 3 Drill holes with the hammer drill.

Step 4 Screw the expansion bolts to fix the base. Ensure that the base is installed in the correct direction.

Step 5 Remove the protective cover of the blind-mate connector.

Step 6 Place the battery module on the base, and ensure that the base and the battery are installed in the same direction. Install the remaining batteries and PCU based on the actual needs.

Step 7 Preinstall the locking bracket to the PCU.

Step 8 Put the PCU above the installed battery module securely. Mark the drilling hole using a marker, then remove the PCU.

Step 9 Drill holes with the hammer drill.

Step 10 Secure the locking bracket to the wall.

Step 11 Install the locking bracket to PCU.

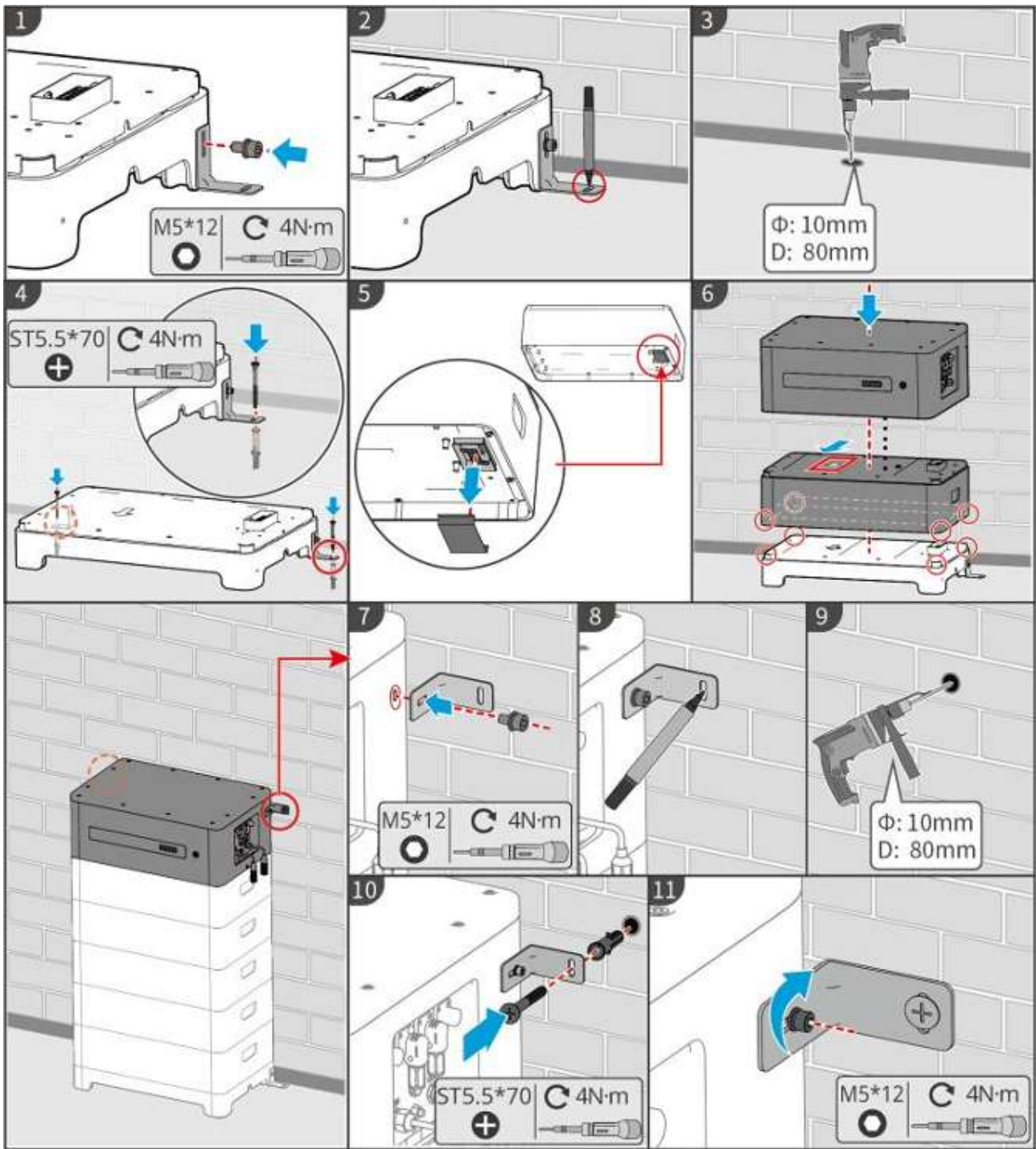

LXF10INT0002

5.4.2 Installing Lynx Home F Plus+

Step 1(Optional) Install the adjustable feet to the base.

Step 2 Install the locking bracket to the base.

Step 3 Place the base cling to the wall and mark the drilling positions. Then remove the base.

Step 4 Drill holes with the hammer drill.

Step 5 Screw the expansion bolts to fix the base. Ensure that the base is installed in the correct direction.

Step 6 Remove the protective cover of the blind-mate connector.

Step 7 Place the battery module on the base, and ensure that the base and the battery are installed in the same direction. Install the remaining batteries and PCU based on the actual needs.

Step 8 Preinstall the locking bracket to the PCU.

Step 9 Put the PCU above the installed battery module securely. Mark the drilling hole using a marker, then

remove the PCU.

Step 10 Drill holes with the hammer drill.

Step 11 Secure the locking bracket to the wall.

Step 12 Install the locking bracket to PCU.

Step 13 (Optional) Check the battery system to ensure that it is installed vertically and securely. In case of tilting or shaking, the battery system can be adjusted by rotating the adjust feet.

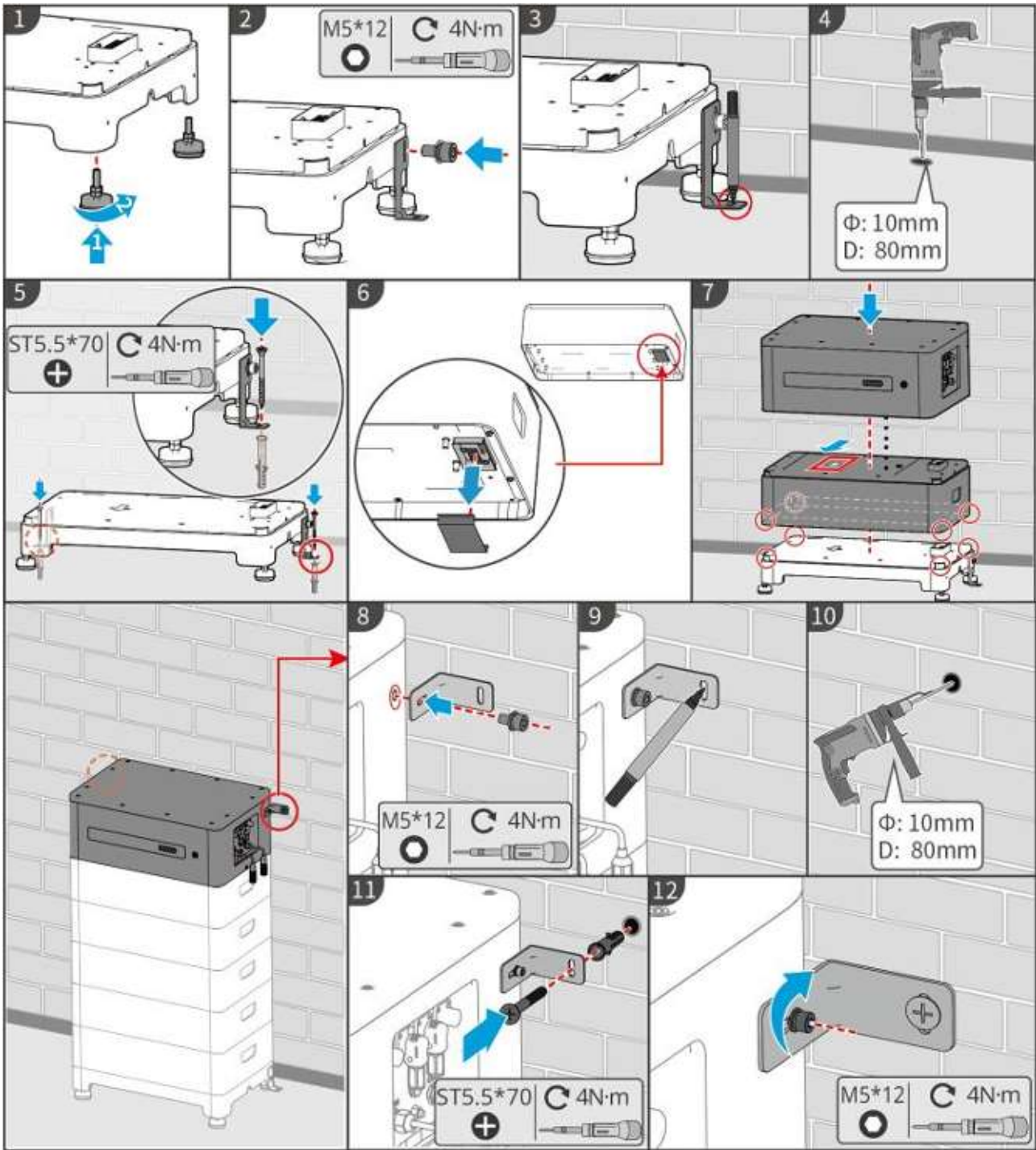

LXF10INT0003

5.4.3 Installing Lynx Home F (G2)

Step 1(Optional) Install the adjustable feet to the base.

Step 2 Install the locking bracket to the base.

Step 3 Place the base cling to the wall and mark the drilling positions. Then remove the base.

Step 4 Drill holes with the hammer drill. Screw the expansion bolts to fix the base. Ensure that the base is

installed in the correct direction.

Step 5 Remove the cover in front of the battery wiring terminal.

Step 6 Place the battery module on the base, and ensure that the base and the battery are installed in the same direction. Install the remaining batteries and PCU based on the actual needs.

Step 7 Install the locking bracket of the PCU.

Step 8 Put the PCU above the installed battery module securely. Mark the drilling hole using a marker, then remove the PCU.

Step 9 Drill holes with the hammer drill.

Step 10 Secure the locking bracket to prevent the PCU from falling down.

Step 11

- (Optional) Fix the locking bracket of PCU.
- (Optional) Install junction box.

Step 12 (Optional) Check the battery system to ensure that it is installed vertically and securely. In case of tilting or shaking, the battery system can be adjusted by rotating the adjust feet.

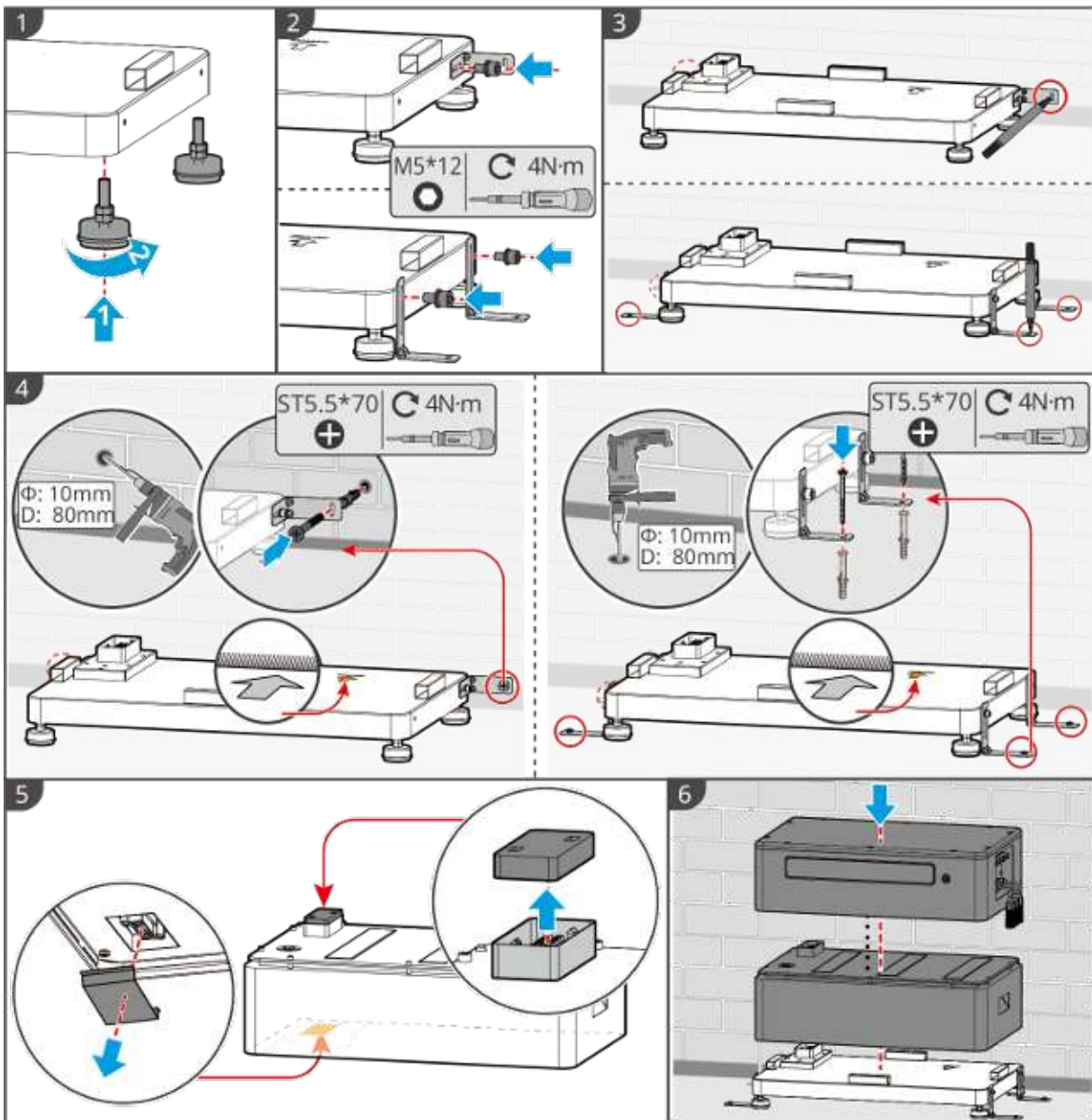

LXF20INT0002

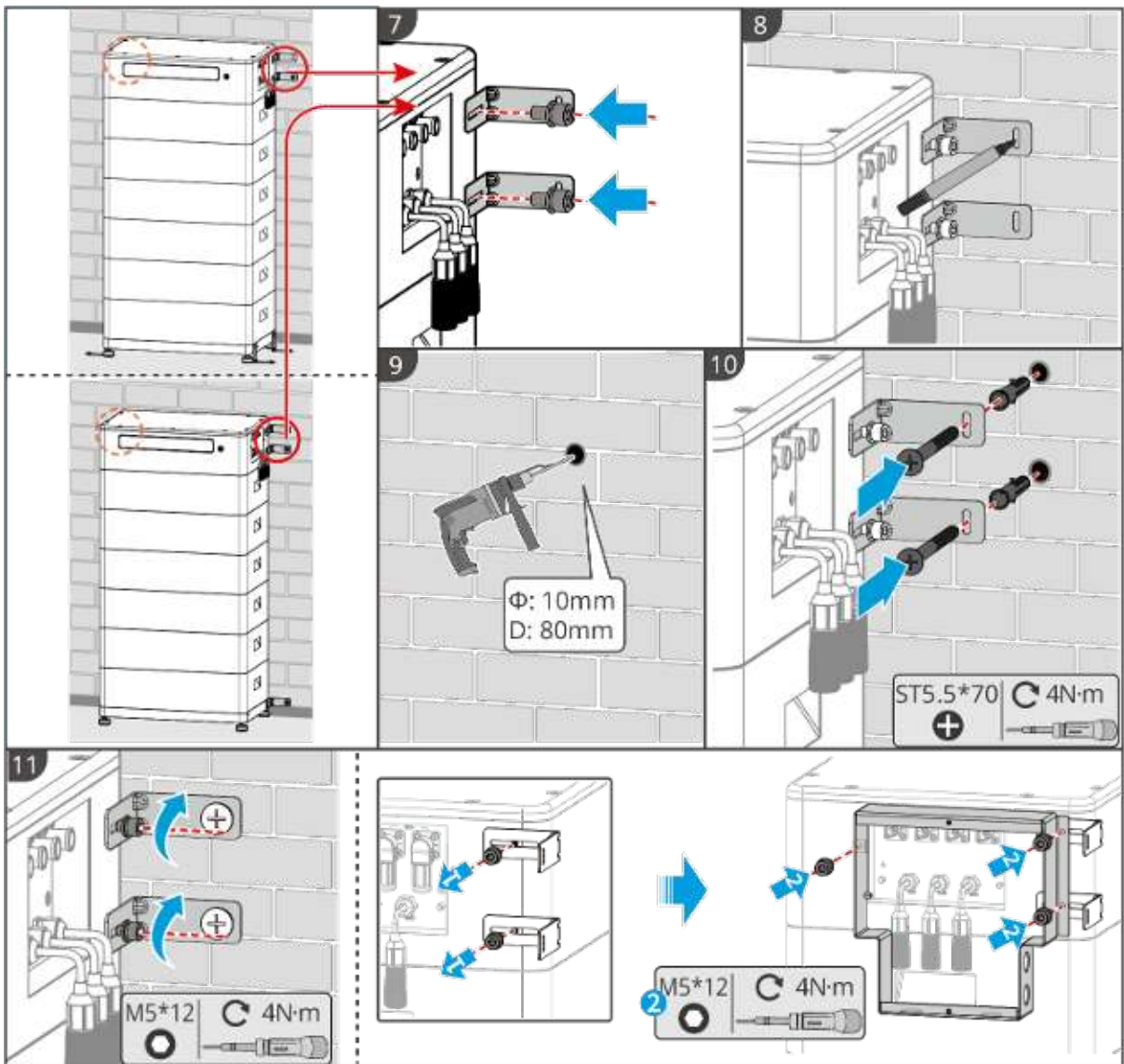

LXF20INT0003

5.4.4 Installing Lynx Home D

NOTICE

- The battery system has to be installed on a base or on a wall mount rack.
- When stacking batteries, auxiliary tools need to be used for installation.
- When a single group of battery exceeds 3 pieces, it is recommended to use a base installation.
- Please stack the batteries based on the recommended stacking method.

Battery Stacking Method

Total Quantity of Batteries (blocks)	First stack (block)	second stack (block)
8	4	4
7	4	3
6	3	3
5	3	2
4	2	2
3	3	-
2	2	-

1	1	-
---	---	---

Installing the Wall Mounting Rack (Optional)

Step 1 Make the wall mount rack tightly adhere to the wall. Ensure that the rack is securely placed and use a level bar to measure if the rack is level. After adjusting the position and levelness of the rack, mark the drilling positions, then remove the rack.

Step 2 Drill holes and install expansion bolt.

1. Drill holes with the hammer drill. Clean the hole.
2. Use a rubber hammer to install the expansion screw into the hole.
3. Use an external hex wrench to tighten the nut clockwise to expand the screw.
4. Rotate the nut counterclockwise to remove it.
5. Use external hex wrench to install the rack on the wall.

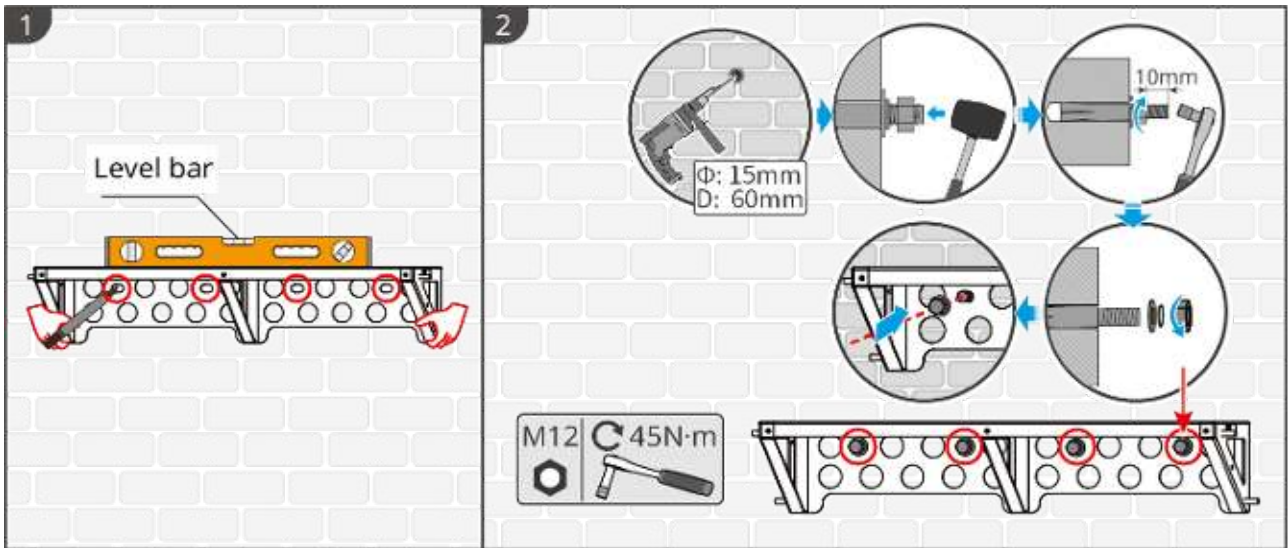

LXD10INT0005

Installing the Base (Optional)

NOTICE

Check whether there are adjustable feet in the package. If not and you need them, please contact the dealer or after-sales service to obtain them.

Install the adjustable feet to the base.

Place the base 15-20mm away from the wall, parallel to the wall, and ensure that the ground is level.

When installing the battery using the base, ensure that the left side of the battery is tightly against the limit block on the base.

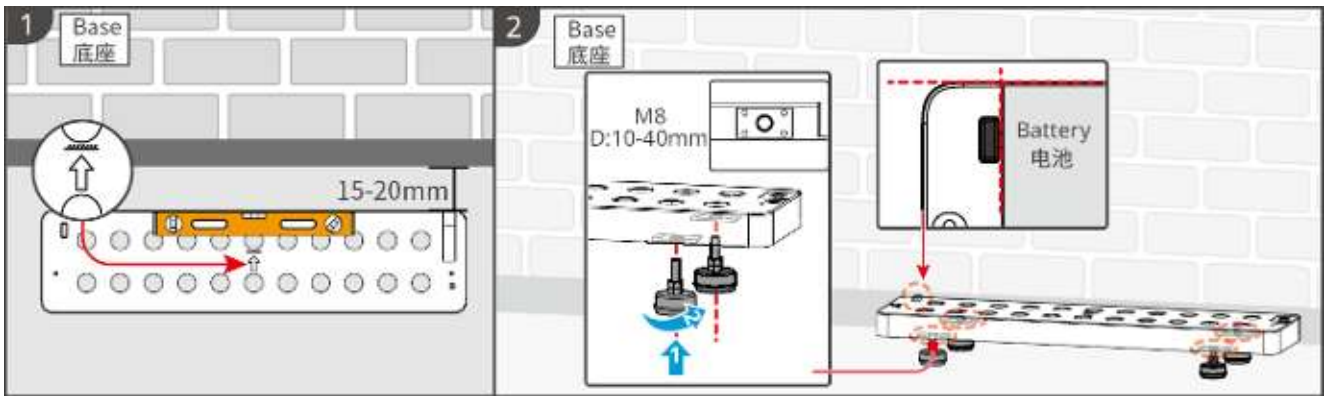

Installing the Battery

Step 1 Preinstall the locking bracket to battery.

Step 2 Use a marker pen to mark the punching position and drill the hole.

1. Drill holes with the hammer drill.(hole diameter: 8mm , depth: 60mm)
2. Clean the hole.

Step 3 Drill holes and install expansion bolt.

1. Use a rubber hammer to install the expansion screw into the hole.
2. Use an external hex wrench to tighten the nut clockwise to expand the screw.
3. Rotate the nut counterclockwise to remove it.
4. Reinstall the battery on the base or rack, and adjust the battery position to make it 15-20mm away from the wall.
5. Use an external hex wrench to secure the battery to the wall, and use a torque screwdriver to secure the locking bracket to the battery.

Step 4 Use brackets to secure the battery system.

Step 5 If multiple batteries need to be installed, please repeat steps 3 to 4 to complete all battery installations. It is not allowed to stack more than 4 batteries in one group.

Step 6 Use locking brackets to secure the battery to the base or rack and then secure the batteries in sequence.

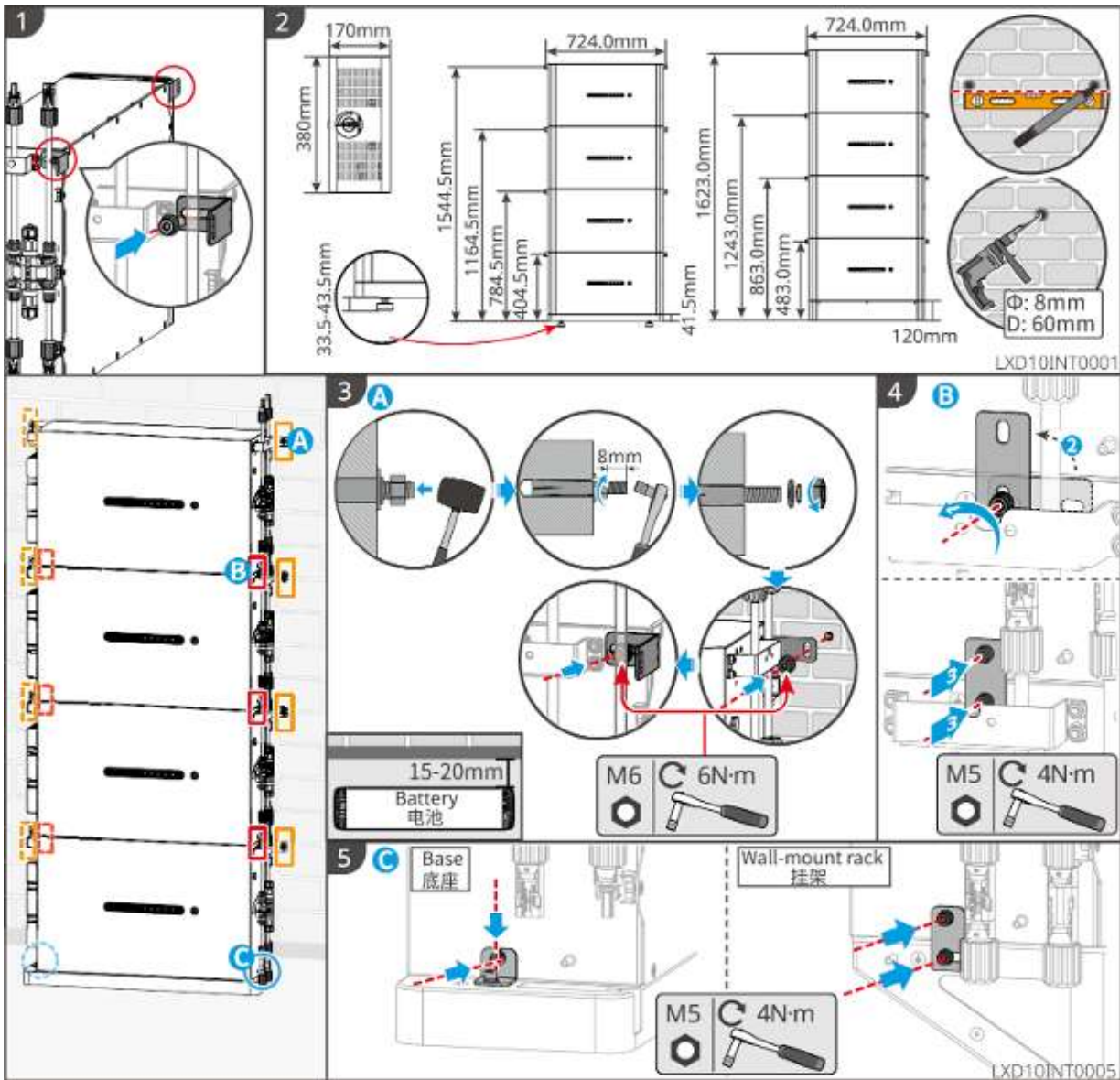

5.5 Installing the Smart Meter

WARNING

In areas at risk of lightning, if the meter cable exceeds 10m and the cables are not wired with grounded metal conduits, you are recommended to use an external lightning protection device.

GM3000

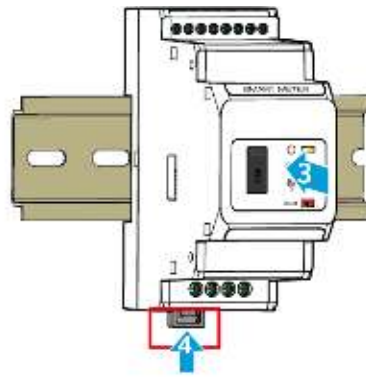
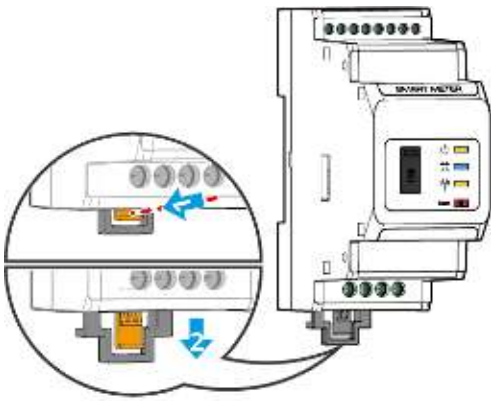

GMK10INT0002

GM330

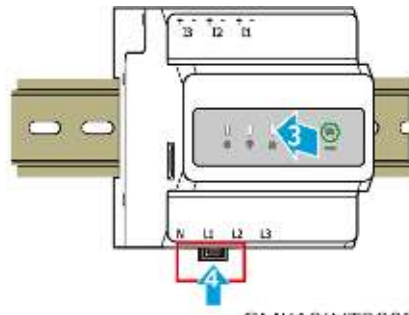
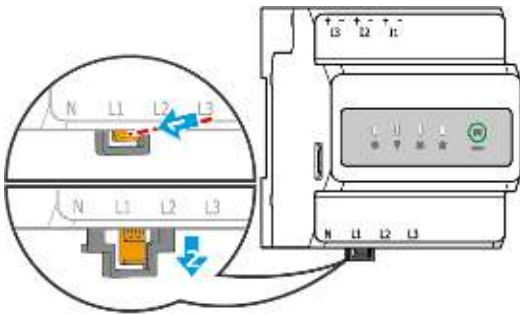

GMK10INT0003

6 System Wirings

DANGER

- Perform electrical connections in compliance with local laws and regulations. Including operations, cables, and component specifications.
- Disconnect the DC switches and the AC output switches to power off the equipment before any electrical connections. Do not work with power on. Otherwise, an electric shock may occur.
- Tie the same type cables together, and place them separately from cables of different types. Do not place the cables entangled or crossed.
- If the cable bears too much tension, the connection may be poor. Reserve a certain length of the cable before connecting it to the Inverter cable port.
- Ensure the cable conductor is in full contact with the terminals during crimping. Do not crimp the cable jacket with the terminal. Otherwise the equipment may not be able to operate, or its terminal block getting damaged due to heating and other phenomenon because of unreliable connection after operation.

NOTICE

- Wear personal protective equipment like safety shoes, safety gloves, and insulating gloves during electrical connections.
- All electrical connections should be performed by qualified professionals.
- Cable colors in this document are for reference only. The cable specifications shall meet local laws and regulations.

6.1 System Wiring Diagram

NOTICE

- N and PE wiring ON-GRID and BACK-UP of the inverter are different based on the regulation requirements of different regions. Refer to the specific requirements of local regulations.
- The inverter is integrated with a built-in smart meter, which can be directly connected to CT.
- The data accuracy will decrease if the cable length between the CT and the inverter exceeds 25m. An external smart meter is required for better precision.
- There are built-in relays inside of the inverter's ON-GRID and BACK-UP AC ports. When the inverter is in the off-grid mode, the built-in ON-GRID relay is open; while when the inverter is in grid-tied mode, it is closed.
- When the inverter is powered on, the BACK-UP AC port is energized. Power off the inverter first if maintenance is required on the BACK-UP loads. Otherwise, it may cause electric shock.

N and PE cables are connected together in the Main Panel for wiring.

NOTICE

- To maintain neutral integrity, the neutral cable of ON-GRID side and BACK-UP side must be connected together, otherwise BACK-UP function will not work.
- The following diagram is applicable to areas in Australia and New Zealand.

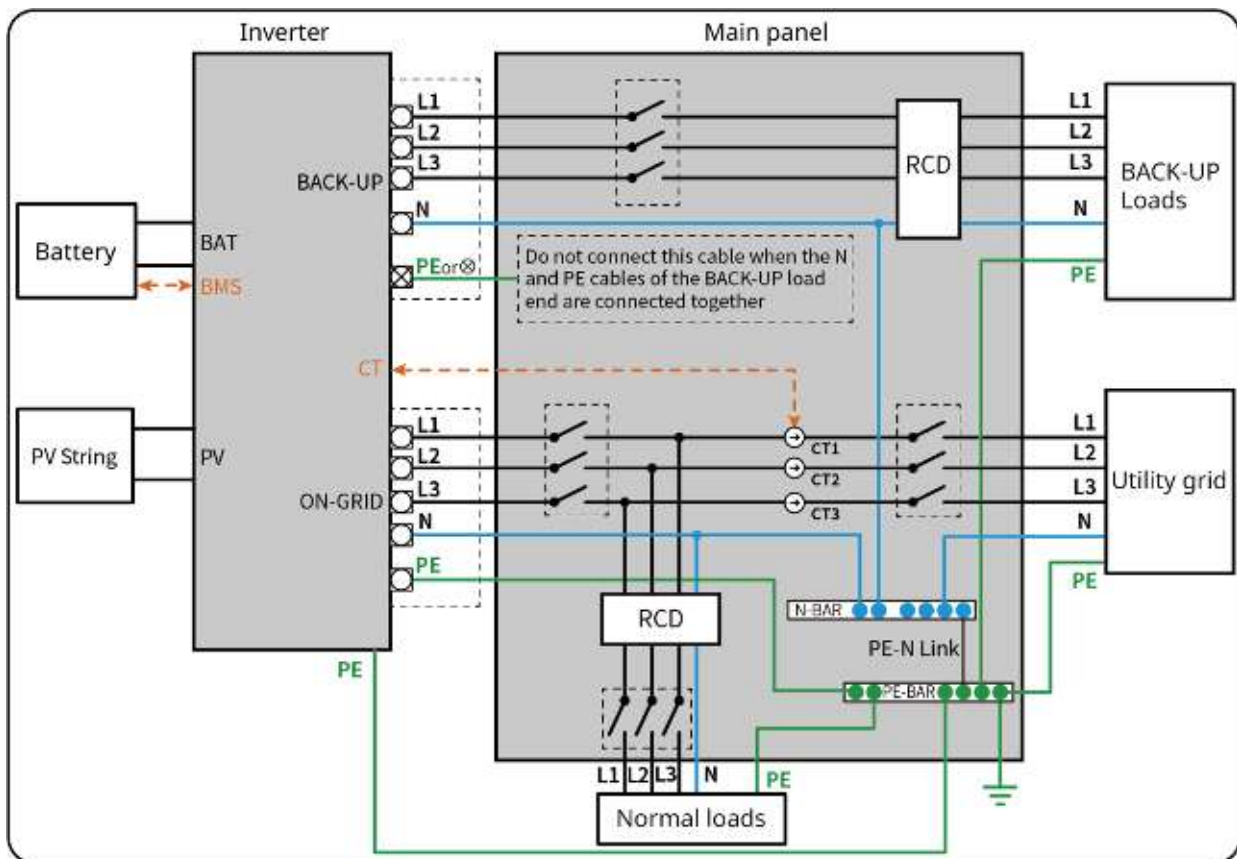

ET1020NET0010

N and PE cables are separately wired in the Main Panel.

NOTICE

- Ensure that the grounding of BACK-UP is correctly and tightened. Otherwise, the BACK-UP function may be abnormal in case of grid failure.
- The following diagram is applicable to areas except Australia or New Zealand.
- In Germany, the internal relay will automatically connect the N wire and PE cable in back-up mode within 100ms and automatically disconnect in on-grid mode.
- In areas other than Germany, the internal relay is disconnected by default in either mode.

- When the inverter switches to off grid mode, the internal relay automatically connects, connecting the PE and N cables.
- When the inverter switches to grid connection mode, the internal relay automatically disconnects, thereby disconnecting the PE and N cables.

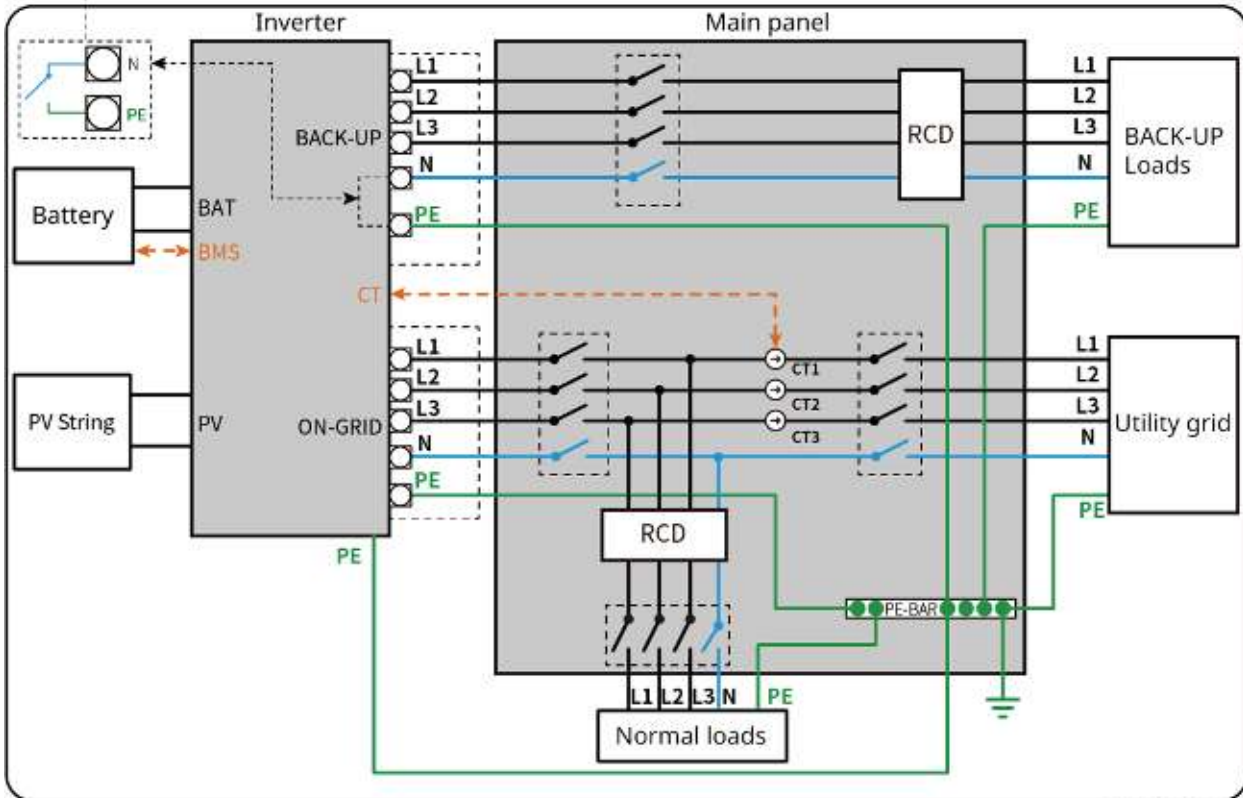

ET1020NET0011

6.2 Detailed System Wiring Diagram

The system wiring diagram takes some models as an example, refer to the electrical connection section and actual used products for more detailed instructions.

6.2.1 Detailed System Wiring Diagram For Single Inverter

Use built-in smart meter in the system

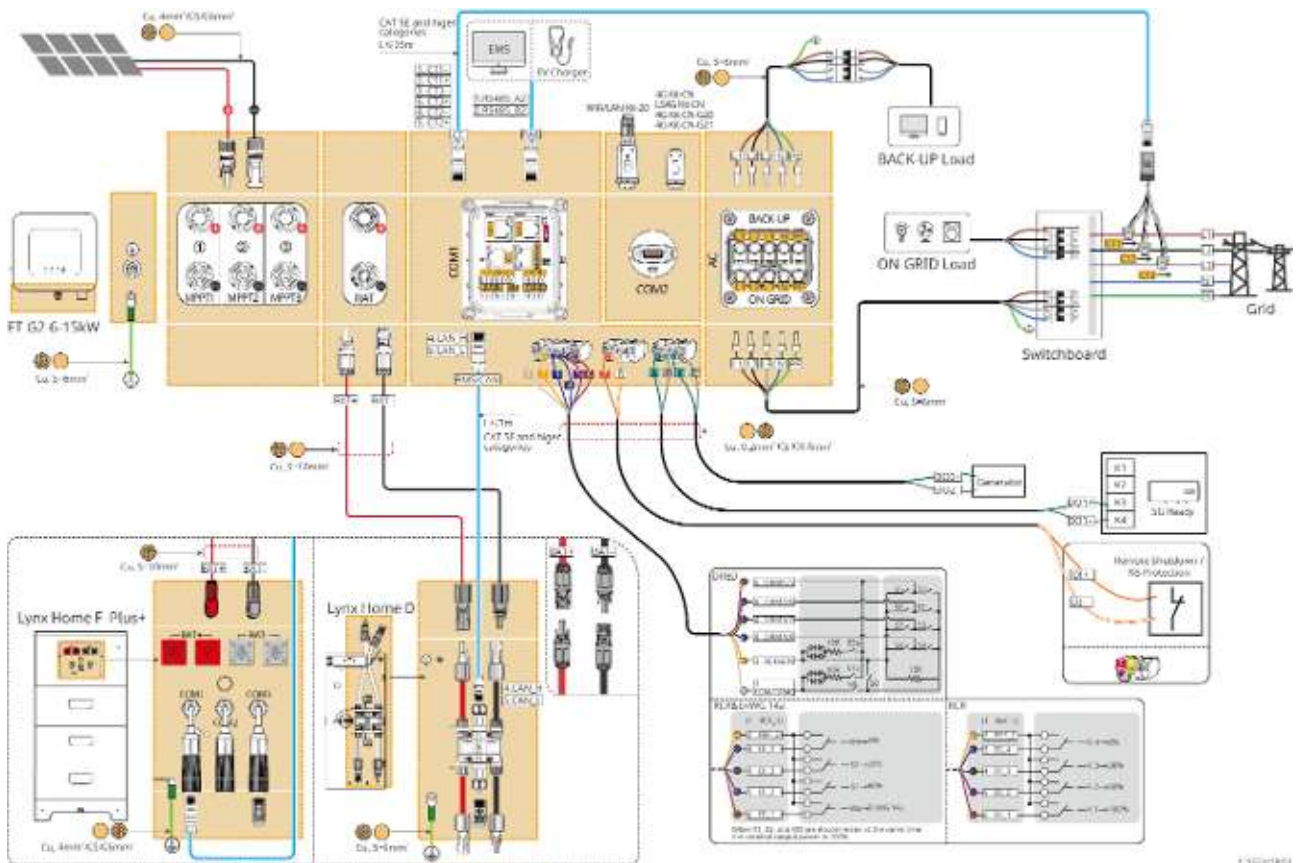

1-10101803

Use GM3000 in the system

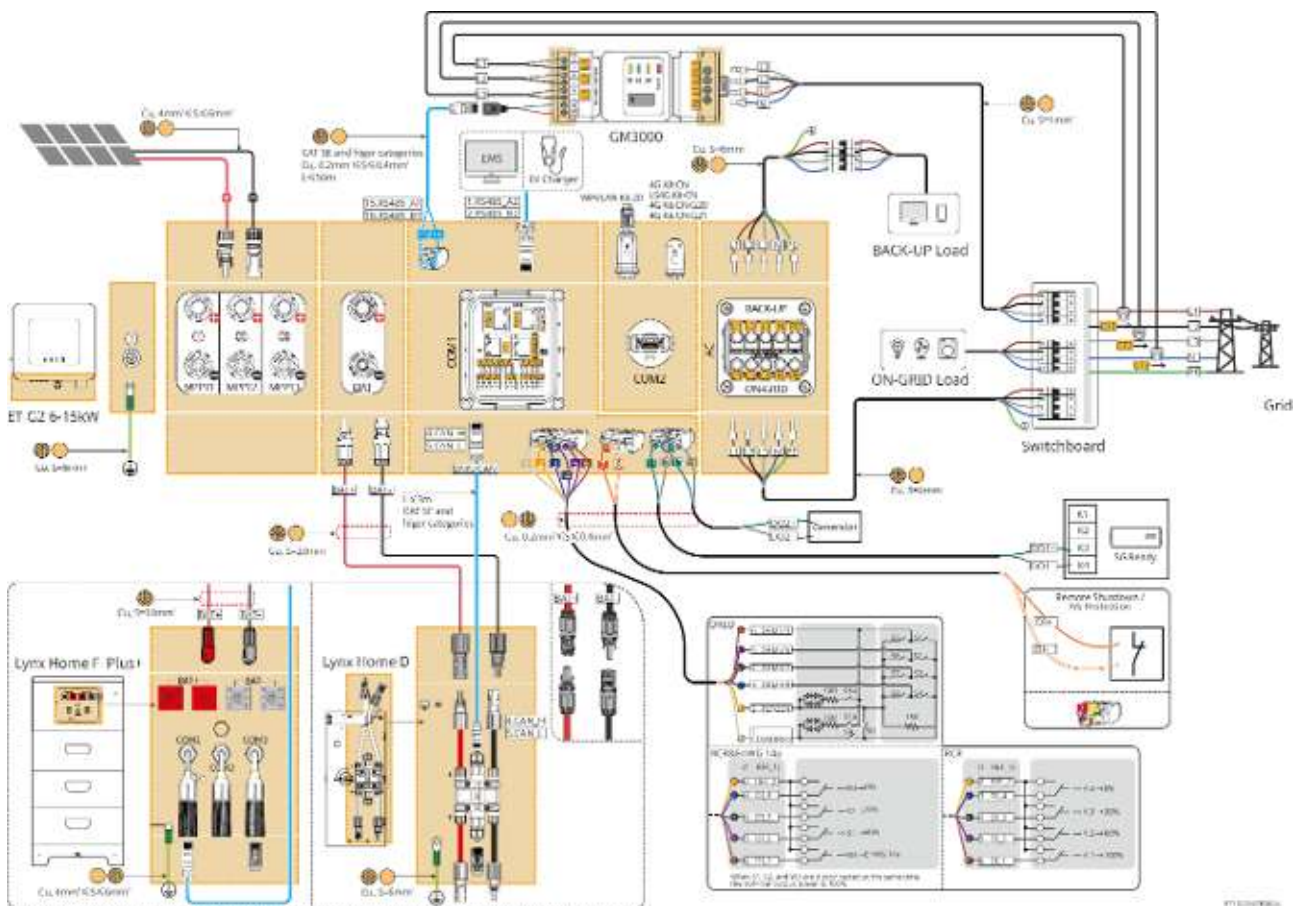

1-10101803

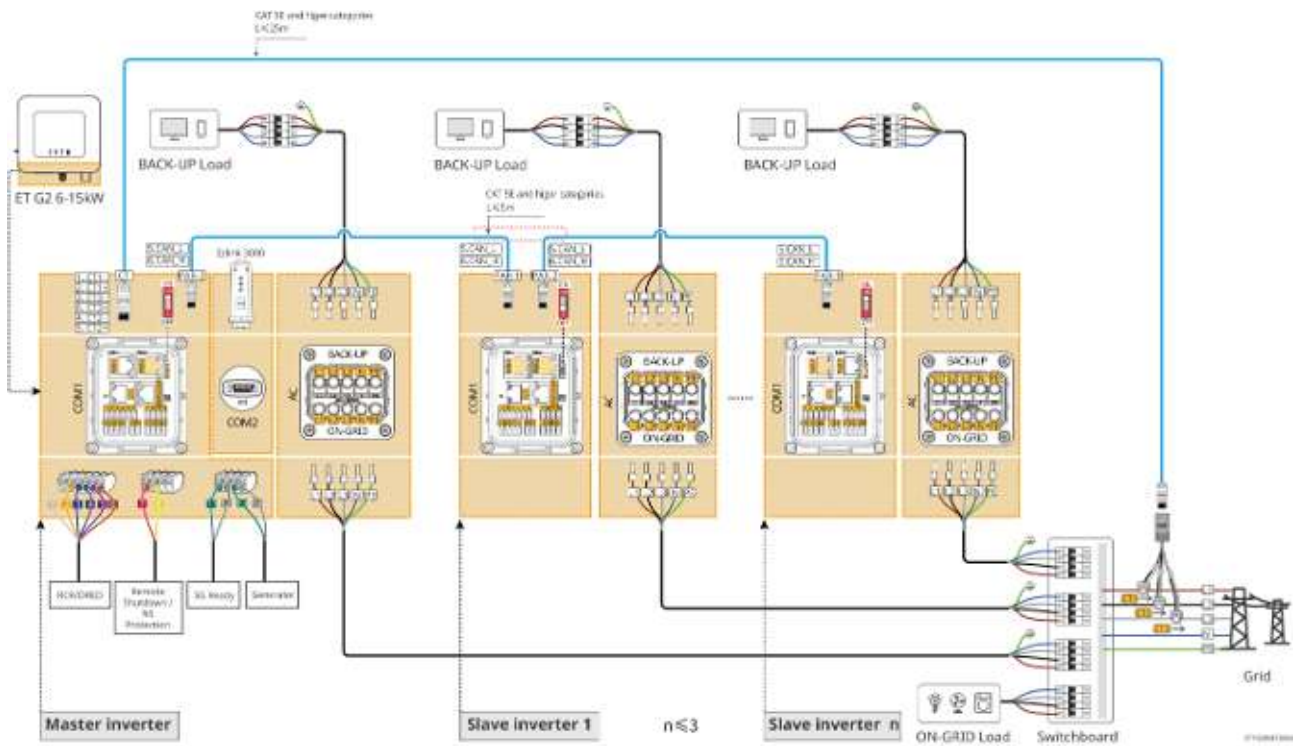

Use GM3000 in the system

The parallel system with GM3000 is similar to the parallel system with GM330. For more details about smart meter connections, refer to the single inverter system.

Use GM330 in the system

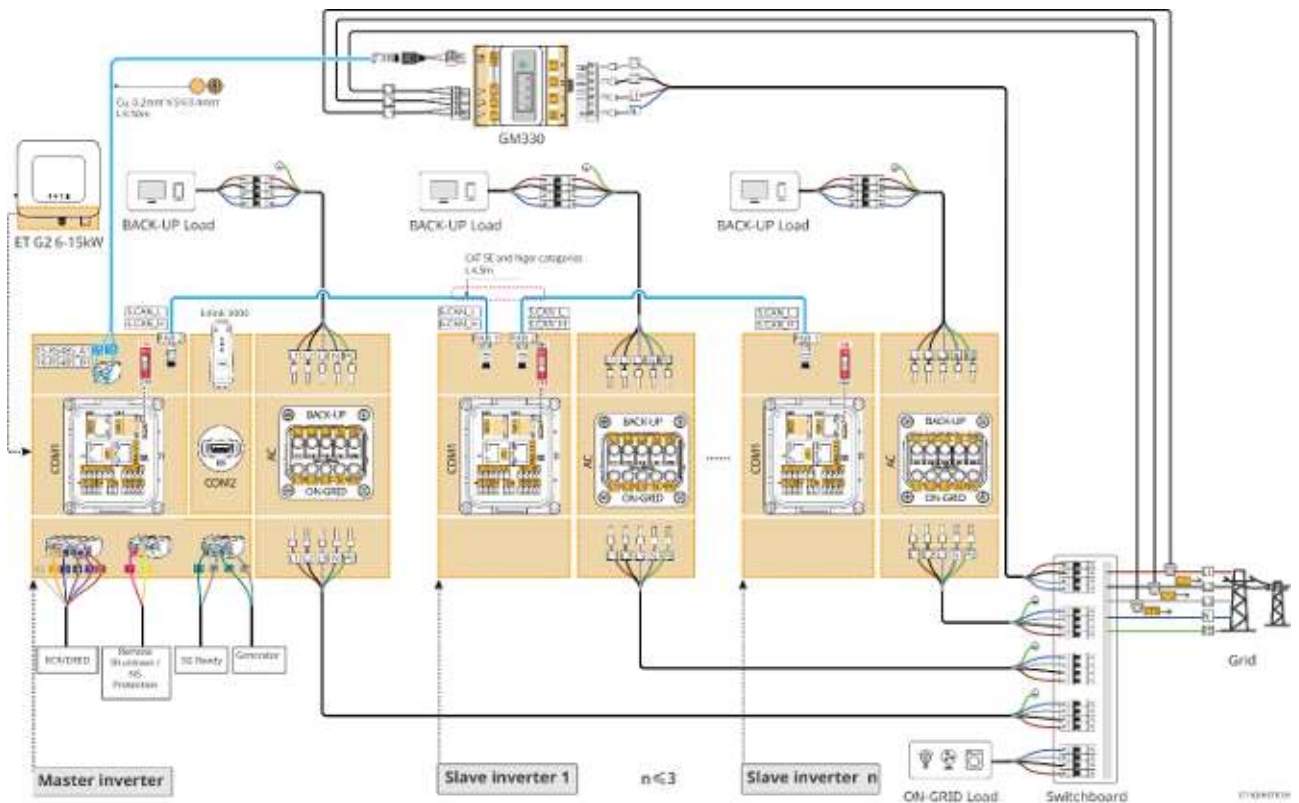

6.3 Preparing Materials



- Do not connect loads between the inverter and the AC switch directly connected to the inverter.
- Install one AC output circuit breaker for each inverter. Multiple inverters cannot share one AC circuit breaker.
- An AC circuit breaker shall be installed on the AC side to make sure that the inverter can safely disconnect the grid when an exception happens. Select the appropriate AC circuit breaker in compliance with local laws and regulations.
- When the inverter is powered on, the BACK-UP AC port is energized. Power off the inverter first if maintenance is required on the BACK-UP loads. Otherwise, it may cause electric shock.

6.3.1 Preparing Breakers

No.	Circuit breaker	Recommended specifications	Source
1	ON-GRID breaker	Nominal voltage $\geq 230V$, nominal current: <ul style="list-style-type: none"> ● GW6000-ET-20: nominal current $\geq 20A$ ● Others: nominal current $\geq 32A$ 	Prepared by customers.
2	BACK-UP breaker	Nominal voltage $\geq 230V$, nominal current: <ul style="list-style-type: none"> ● GW6000-ET-20: nominal current $\geq 20A$ ● GW8000-ET-20: nominal current $\geq 25A$ ● Others: nominal current $\geq 32A$, nominal voltage $\geq 230V$ AC 	Prepared by customers.
3	Battery breaker	Optional in compliance with local laws and regulations <ul style="list-style-type: none"> ● 2P DC breaker ● GW6000-ET-20, GW8000-ET-20: nominal current $\geq 40A$, nominal voltage $\geq 720VDC$ ● Others: nominal current $\geq 50A$, nominal voltage $\geq 720V$ DC 	Prepared by customers.
4	RCD	Optional in compliance with local laws and regulations <ul style="list-style-type: none"> ● Type A ● ON-GRID RCD: 300mA ● BACK-UP RCD: 30mA 	Prepared by customers.
5	Smart meter breaker	<ul style="list-style-type: none"> ● Nominal Voltage: 380V/ 400V ● Nominal current: 0.5A 	Prepared by customers.

6.3.2 Preparing Cables

No.	Cable	Recommended specifications	Obtain method
1	Inverter PE cable	<ul style="list-style-type: none"> ● Single-core outdoor copper cable ● Conductor cross-sectional area: $S=6mm^2$ 	Prepared by customers.

2	Battery PE cable	<ul style="list-style-type: none"> ● Single-core outdoor copper cable ● Conductor cross-sectional area: 6mm² 	Prepared by customers.
3	PV DC cable	<ul style="list-style-type: none"> ● Commonly used outdoor photovoltaic cable ● Conductor cross-sectional area: 4mm²-6mm² ● Outer diameter: 5.9mm-8.8mm 	Prepared by customers.
4	Battery DC cable	<ul style="list-style-type: none"> ● Single-core outdoor copper cable ● Conductor cross-sectional area: 10mm² ● Outer diameter: 6.5mm-8.5mm 	Prepared by customers or buy from GoodWe.
5	AC cable	<ul style="list-style-type: none"> ● Multi-core outdoor copper cable ● Conductor cross-sectional area: 6mm² ● Outer diameter: 18mm 	Prepared by customers.
6	Smart meter power cable	Outdoor copper cable Conductor cross-sectional area: 1mm ²	Prepared by customers.
7	BMS communication cable	Customized communication cable. Default length: 3m. Recommended specifications if needed: CAT 5E or higher categories standard net cable with RJ45 connector.	Included in the package of the inverter.
8	(Optional) Smart meter RS485 communication cable	Standard network cable: CAT 5E or higher categories standard shielded net cable with RJ45 connector.	RJ45-2PIN adapter and standard net cable: included in the package of the inverter.
9	Communication cable for battery parallel connection	CAT 5E or higher categories standard net cable with RJ45 connector.	Prepared by customers.
10	DO communication cable for load control or generator control	<ul style="list-style-type: none"> ● Shielded cable that meet local requirements 	Prepared by customers.
11	Remote shutdown communication cable	<ul style="list-style-type: none"> ● Conductor cross-sectional area: 0.2mm²-0.4mm² ● Outer diameter: 5mm-8mm 	Prepared by customers.
12	RCR/DRED communication cable		Prepared by customers.
13	Communication cable for parallel connected inverters	<ul style="list-style-type: none"> ● RJ45 connector ● CAT 5E or higher categories straight-through network cable ● Recommended cable length: ≤5m 	Prepared by customers.
14	EMS communication cable or Charging Pile Communication Cable	CAT 5E or higher categories standard net cable with RJ45 connector.	Prepared by customers.
15	CT cable		Prepared by

6.4 Connecting the PE cable

WARNING

- Connect the PE cable first before installing the equipment. Disconnect the PE cable before dismantling the equipment.
- The PE cable connected to the enclosure of the inverter cannot replace the PE cable connected to the AC output port. Make sure that both of the two PE cables are securely connected.
- Make sure that all the grounding points on the enclosures are equipotentially connected when there are multiple inverters.
- To improve the corrosion resistance of the terminal, you are recommended to apply silica gel or paint on the ground terminal after installing the PE cable.

Inverter

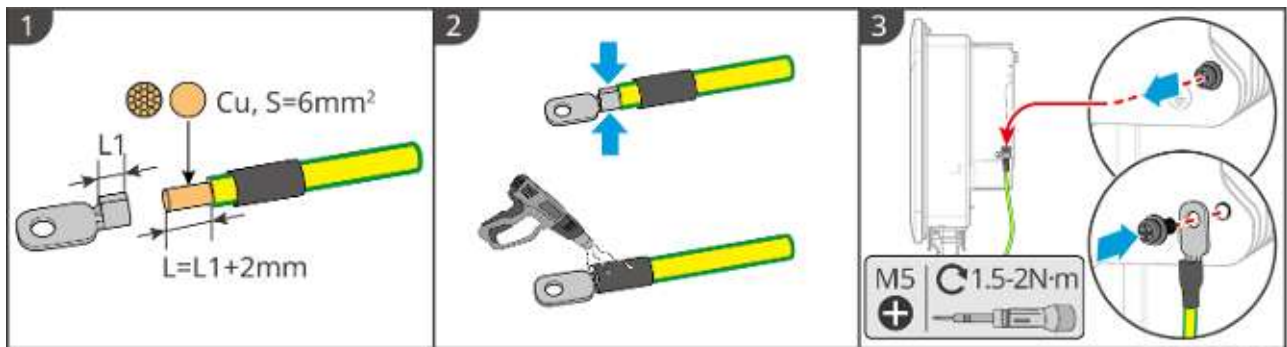

ET1020ELC0001

Battery system

NOTICE

The drawing force of the cable after crimping should be at least 400N.

Lynx Home F Series

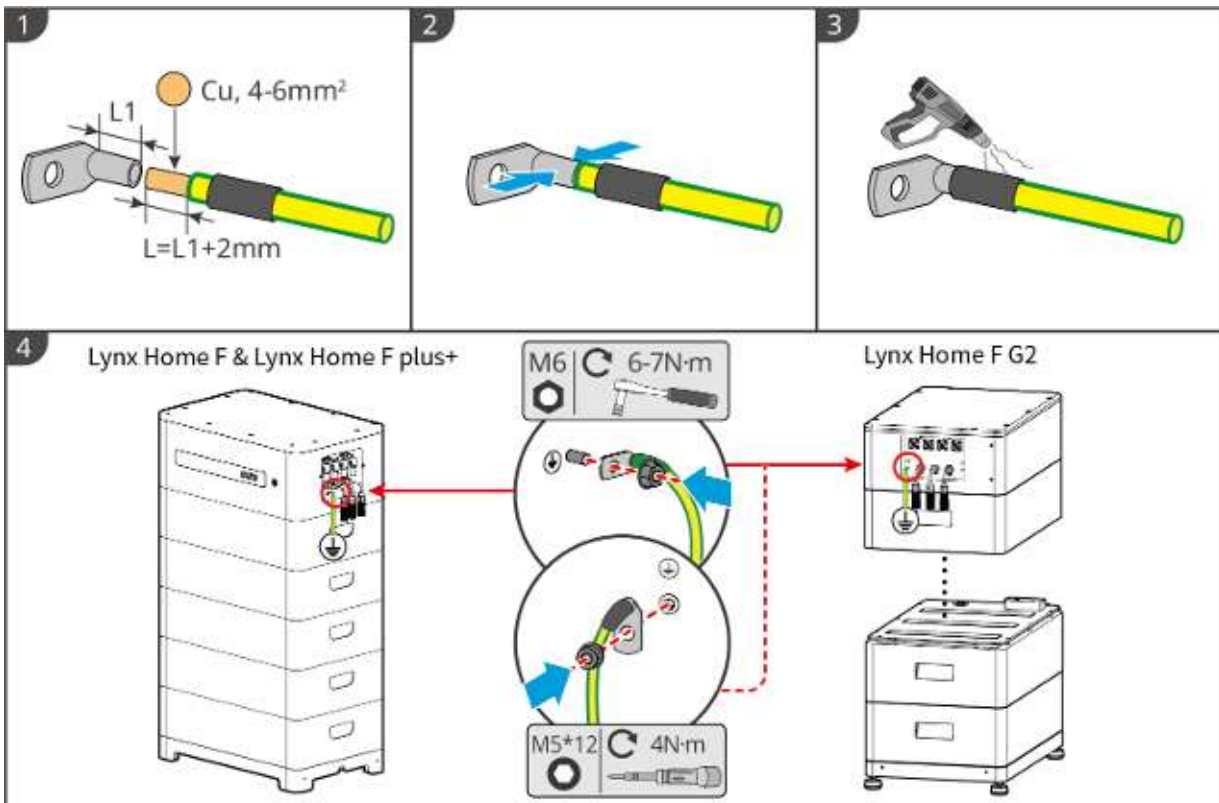

LXF10ELC0001

Lynx Home D

Connect the grounding cable to any grounding point of the battery system.

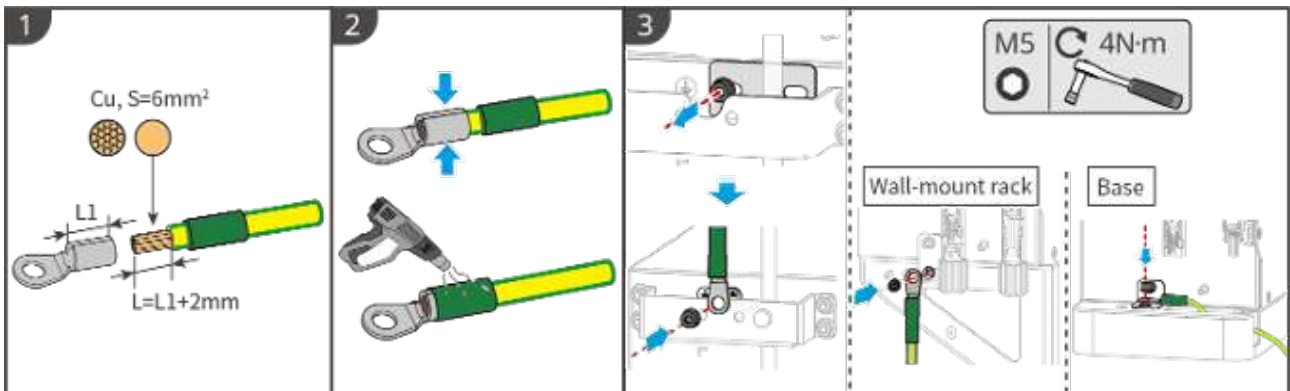

LXD10ELC0001

6.5 Connecting the PV Cable



- Do not connect one PV string to more than one inverter at the same time. Otherwise, it may cause damage to the inverter.
- High voltage exists when the PV string is exposed to the sunlight, pay attention during electrical connections.
- Confirm the following information before connecting the PV string to the inverter. Otherwise, the inverter may be damaged permanently or even cause fire and cause personal and property losses.
 1. Make sure that the max short circuit current and the max input voltage per MPPT are within the permissible range.

2. Make sure that the positive pole of the PV string connects to the PV+ of the inverter. And the negative pole of the PV string connects to the PV- of the inverter.

! WARNING

- The PV strings cannot be grounded. Ensure the minimum insulation resistance of the PV string to the ground meets the minimum insulation resistance requirements before connecting the PV string to the inverter ($R = \text{maximum input voltage} / 30\text{mA}$).
- Ensure the DC cables are connected tightly, securely and correctly.
- Measure the DC cable using the multimeter to avoid reverse polarity connection. Also, the voltage should be within the permissible range.

NOTICE

The two input strings per MPPT should be of the same type, the same number of modules, the same tilt and angle to ensure the best efficiency.

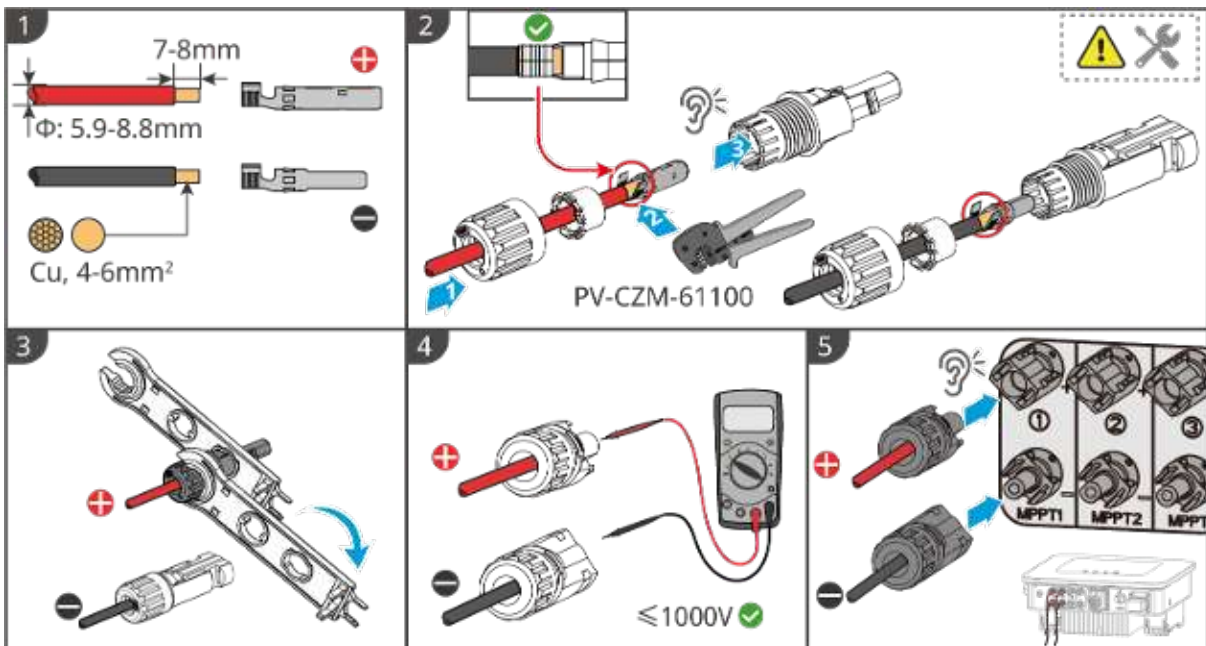

ET1020ELC0002

6.6 Connecting the Battery Cable

! DANGER

- Do not connect one battery pack to more than one inverter at the same time. Otherwise, it may cause damage to the inverter.
- It is forbidden to connect loads between the inverter and batteries.
- When connecting battery cables, use insulated tools to prevent accidental electric shock or short circuit to the batteries.
- Ensure that the open circuit voltage of the battery is within the permissible range of the inverter.
- Install a DC breaker between the inverter and the battery in compliance with local laws and regulations.

注意

When using Lynx Home D batteries:

- Please choose the appropriate crimp terminals for the cables based on the actual connected devices.
- Please use appropriate hydraulic pliers according to the DC connector model. The recommended

specifications are:

- ✧ The recommended tool for crimping battery DC terminals without HD Locking terminal labels on the ziplock bag in the delivery is the YQK-70 hydraulic pliers.
- ✧ The recommended tool for crimping battery DC terminals without HD Locking terminal labels on the ziplock bag in the delivery is the YQK-70 hydraulic pliers.
- ✧ If the recommended hydraulic plier cannot be purchased, please choose the crimping tool according to the terminal size to ensure that the crimped terminals meet the usage requirements.
- Please use the DC connectors and terminals delivered to connect the power cables:
 - ✧ For the black power cable of the battery system with a HD word label or with a white number tube, please plug it into the connector with the HD Locking terminal label on the ziplock bag in the delivery.
 - ✧ For the black power cable of the battery system without a HD word label or without a white number tube, please check whether the HD Locking terminal label is affixed to the ziplock bag containing the power connectors. If no, the male and female connectors should be plugged into each other. If there is an HD Locking terminal label, please contact the dealer or after-sales service.

Battery system wiring diagram

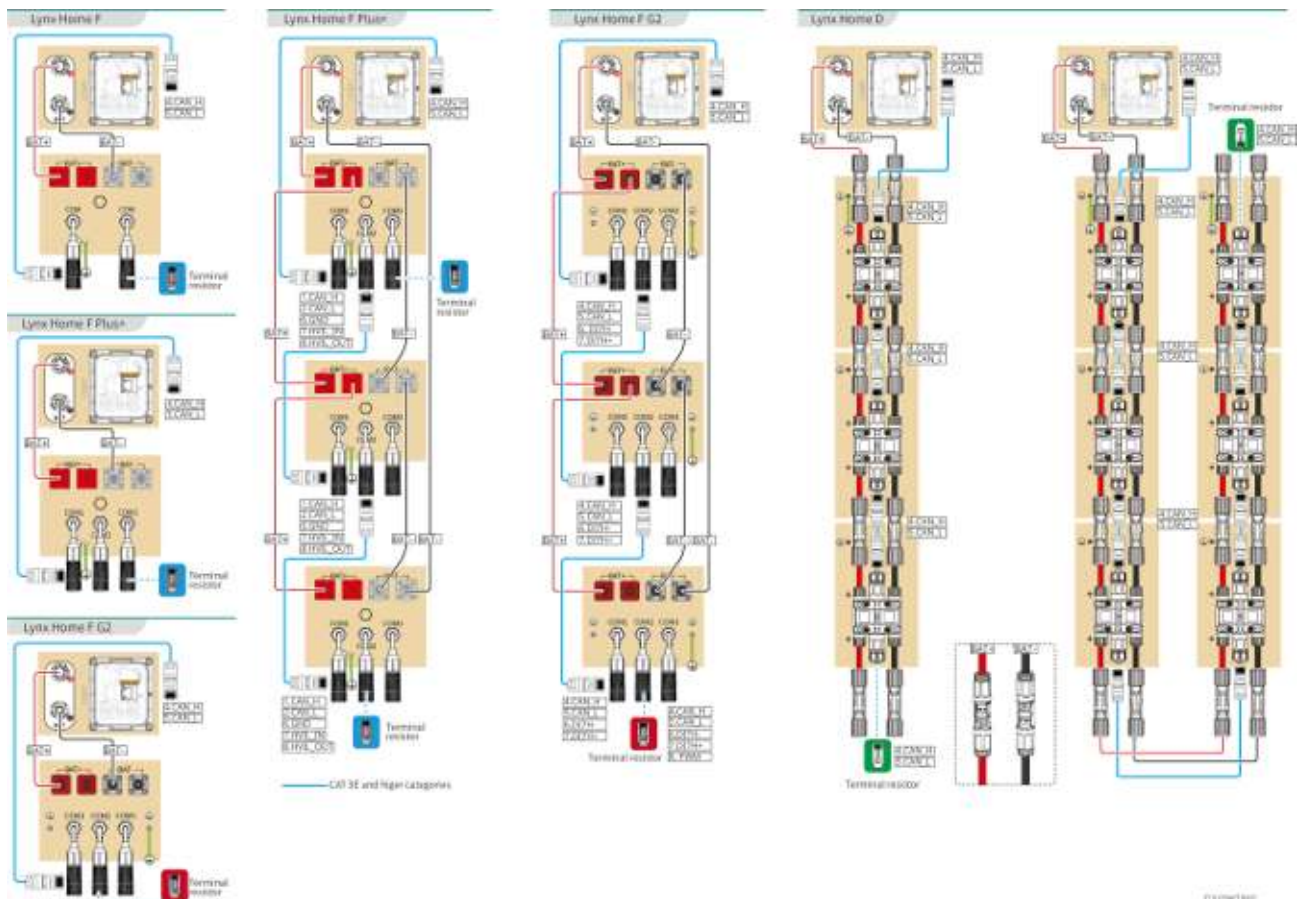

BMS communication between the inverter and the Lynx Home F Series battery:

Inverter port	Connected to the battery port	Port definition	Description
BMS	COM1/COM2/COM	4: CAN_H 5: CAN_L	The inverter communicates with the battery through CAN.

Definition of the battery communication port (Lynx Home F):

PIN	COM	Description
4	CAN_H	Connects to the inverter BMS communication port to communication with the inverter; or terminal resistor.
5	CAN_L	
1, 2, 3, 6, 7, 8	-	-

Communication between the parallel connected Lynx Home F Plus Series batteries:

PIN	COM1	COM2	COM3	Description
1	CAN_H	CAN_H	CAN_H	BMS communication for battery system parallel connections
2	CAN_L	CAN_L	CAN_L	
3	-	-	-	Reserved
4	CAN_H	-	-	<ul style="list-style-type: none"> ● COM1: connects to the inverter BMS communication port to communication with the inverter ● COM2, COM3: reserved
5	CAN_L	-	-	
6	GND	GND	GND	PIN for grounding.
7	HVIL_IN	HVIL_IN	-	<ul style="list-style-type: none"> ● COM1, COM2: interlock function ● COM3: reserved
8	HVIL_OUT	HVIL_OUT	-	

Communication between the parallel connected Lynx Home F G2 Series batteries:

PIN	COM1	COM2	COM3	Description
1	RS485_A1	RS485_A1	Reserved	Connects the external communication device through RS485
2	RS485_B1	RS485_B1		
3	-	-		Reserved
4	CAN_H	CAN_H		Connect the inverter communication port or battery parallel communication port
5	CAN_L	CAN_L		
6	DI7H-	DI7H-		Detects the cluster signal of the battery system.
7	DI7H+	DI7H+		
8	-	PWM		Sends paralleled PWM signals.

Communication between the inverter and the Lynx Home D battery

Inverter port	Connected to the battery port	Port definition	Description
BMS1	COM	4: CAN_H 5: CAN_L	<ul style="list-style-type: none"> ● The inverter communicates with the battery through CAN. ● Connects the BMS1 port of the inverter to the communication port of the battery.

Definition of the Lynx Home D communication port:

PIN	Battery port	Description
1	RS485_A1	Reserved
2	RS485_B1	
4	CAN_H	Connect the inverter communication prot or battery parallel communication port
5	CAN_L	
3/6/7/8	-	-

6.6.1 Connecting the Power Cable Between the Inverter and Battery

⚠ WARNING

- Measure the DC cable using the multimeter to avoid reverse polarity connection. Also, the voltage should be within the permissible range.
- Connect the battery cables to the corresponding terminals such BAT+, BAT- and grounding ports correctly. Otherwise it will cause damage to the inverter.
- Ensure that the whole cable cores are inserted into the terminal holes. No part of the cable core can be exposed.
- Ensure that the cables are connected securely. Otherwise it will cause damage to the inverter due to overheat during its operation.
- Do not connect one battery pack to more than one inverter at the same time. Otherwise, it may cause damage to the inverter.

Inverter + Lynx Home F battery

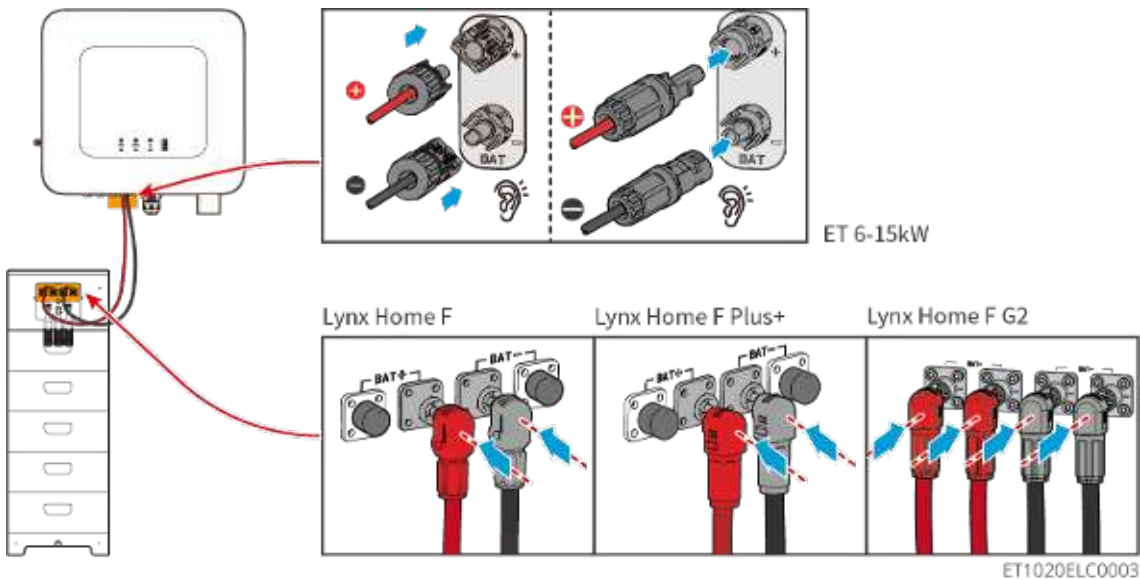

Inverter + Lynx Home D

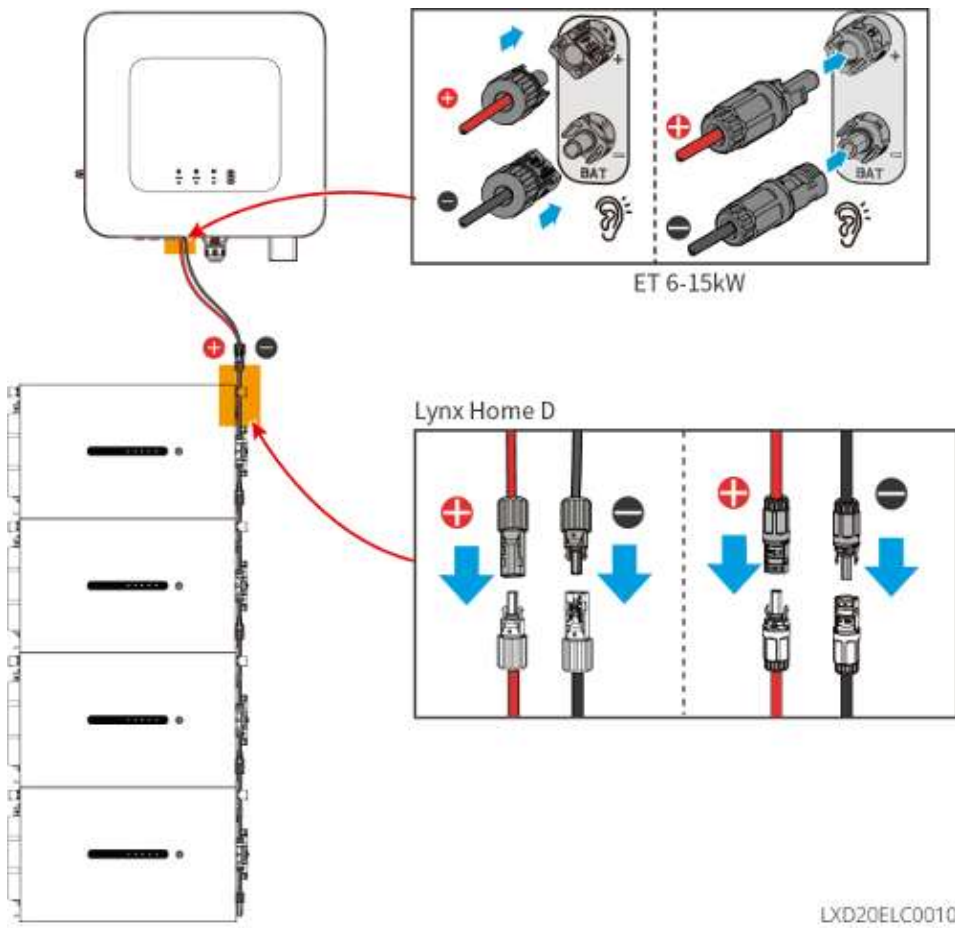

Make the inverter power cable

Type I

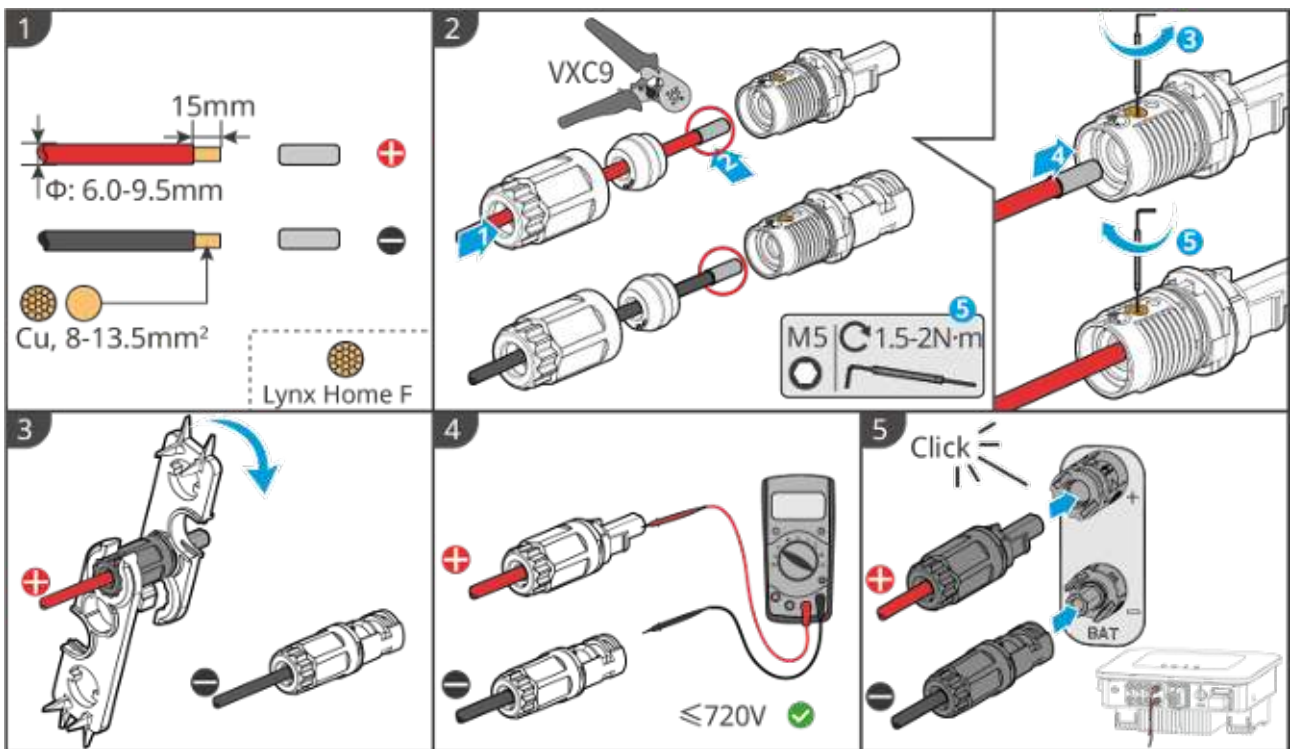

Type II

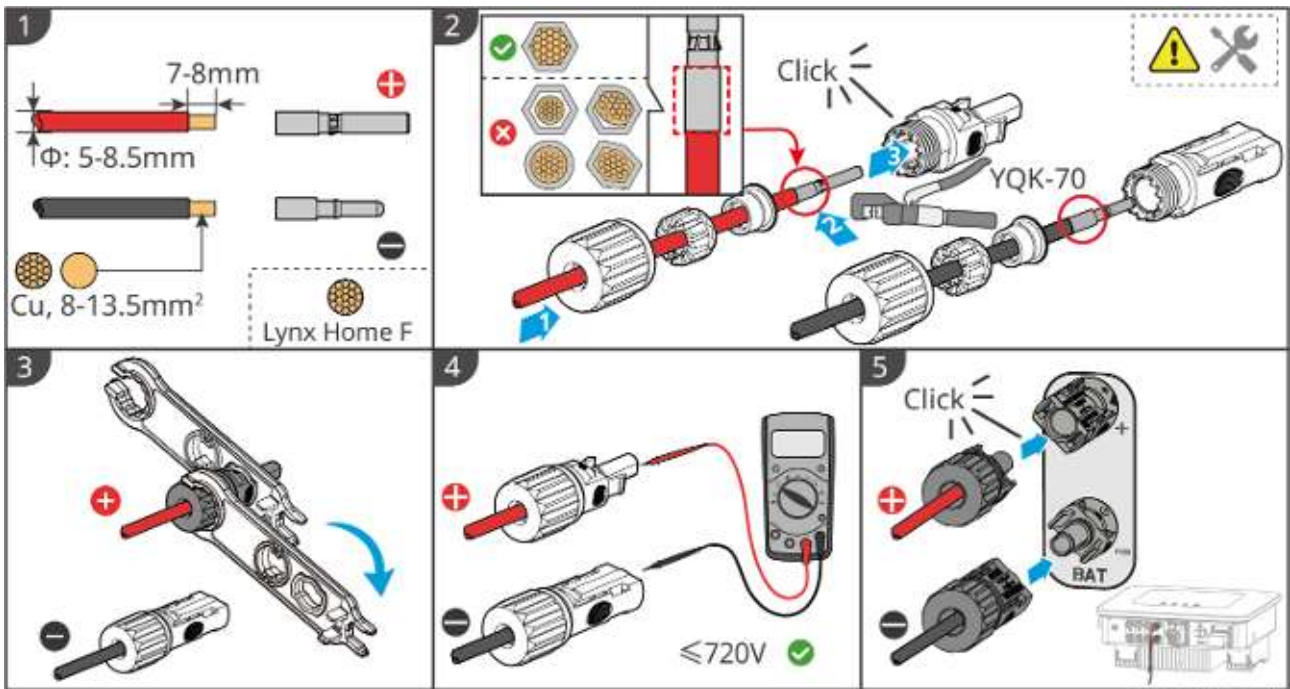

ET1020ELC0011

Make the battery power cable (Lynx Home F)

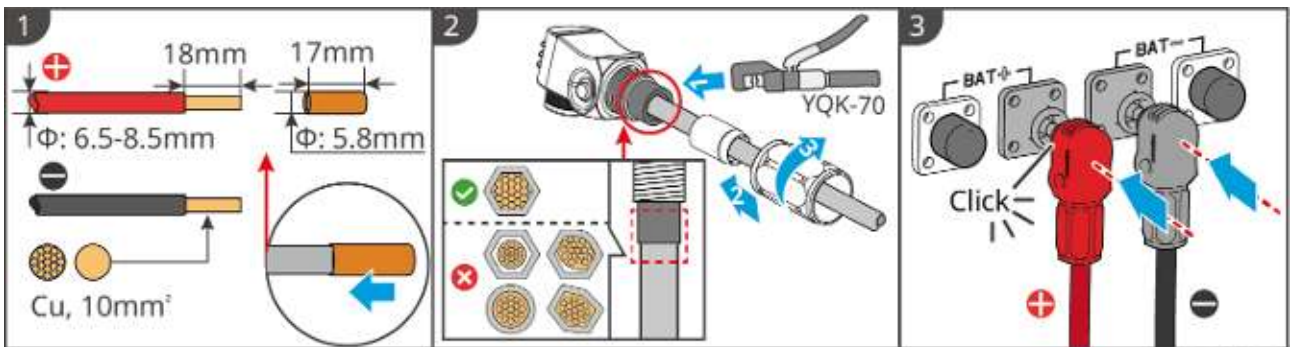

LXF10ELC0006

Make the battery power cable (Lynx Home F Plus)

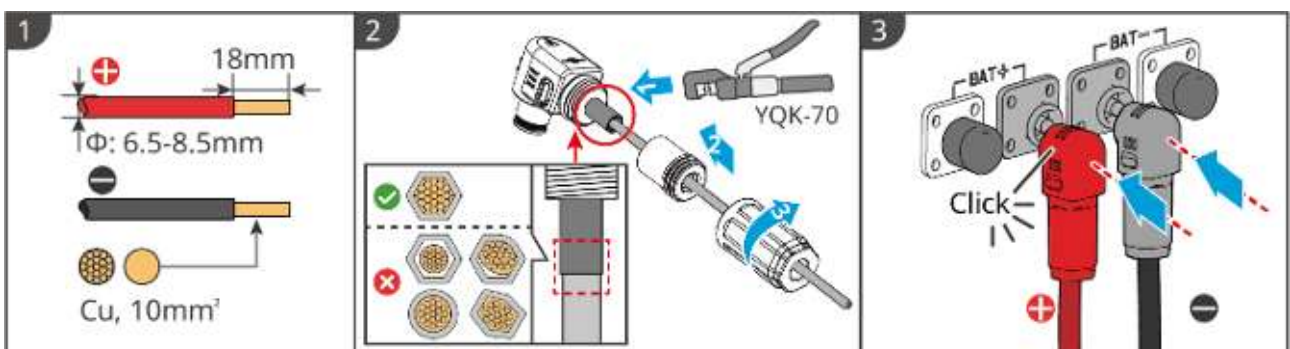

LXF10ELC0007

Make the battery power cable (Lynx Home F G2)

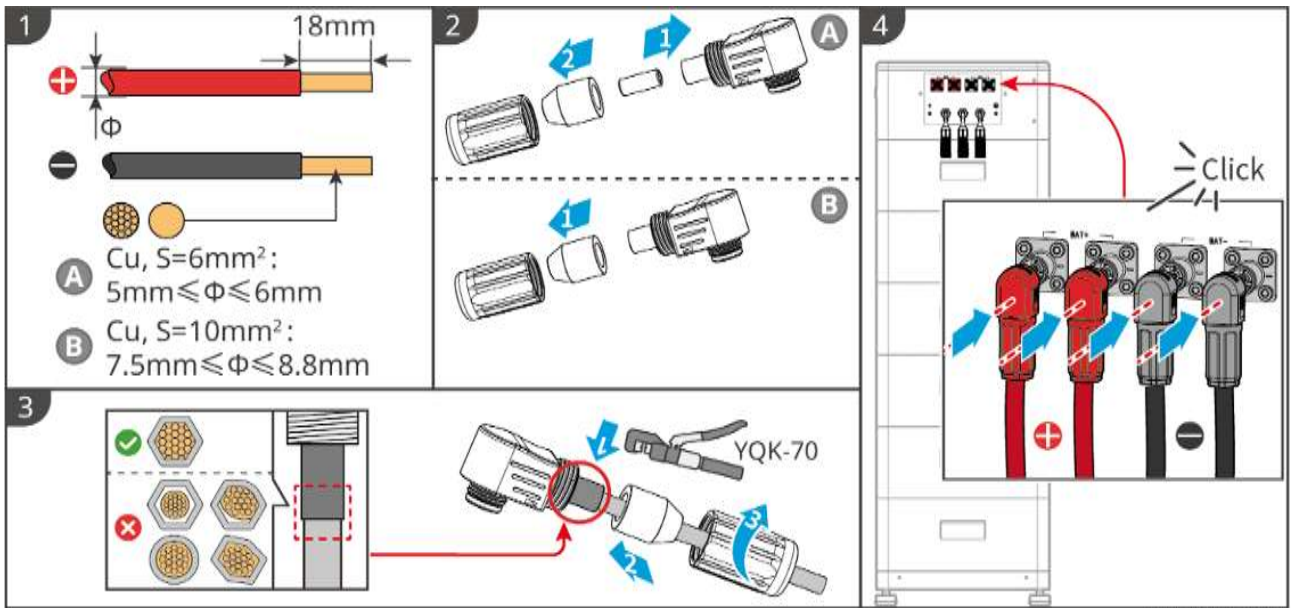

Make the battery power cable (Lynx Home D)

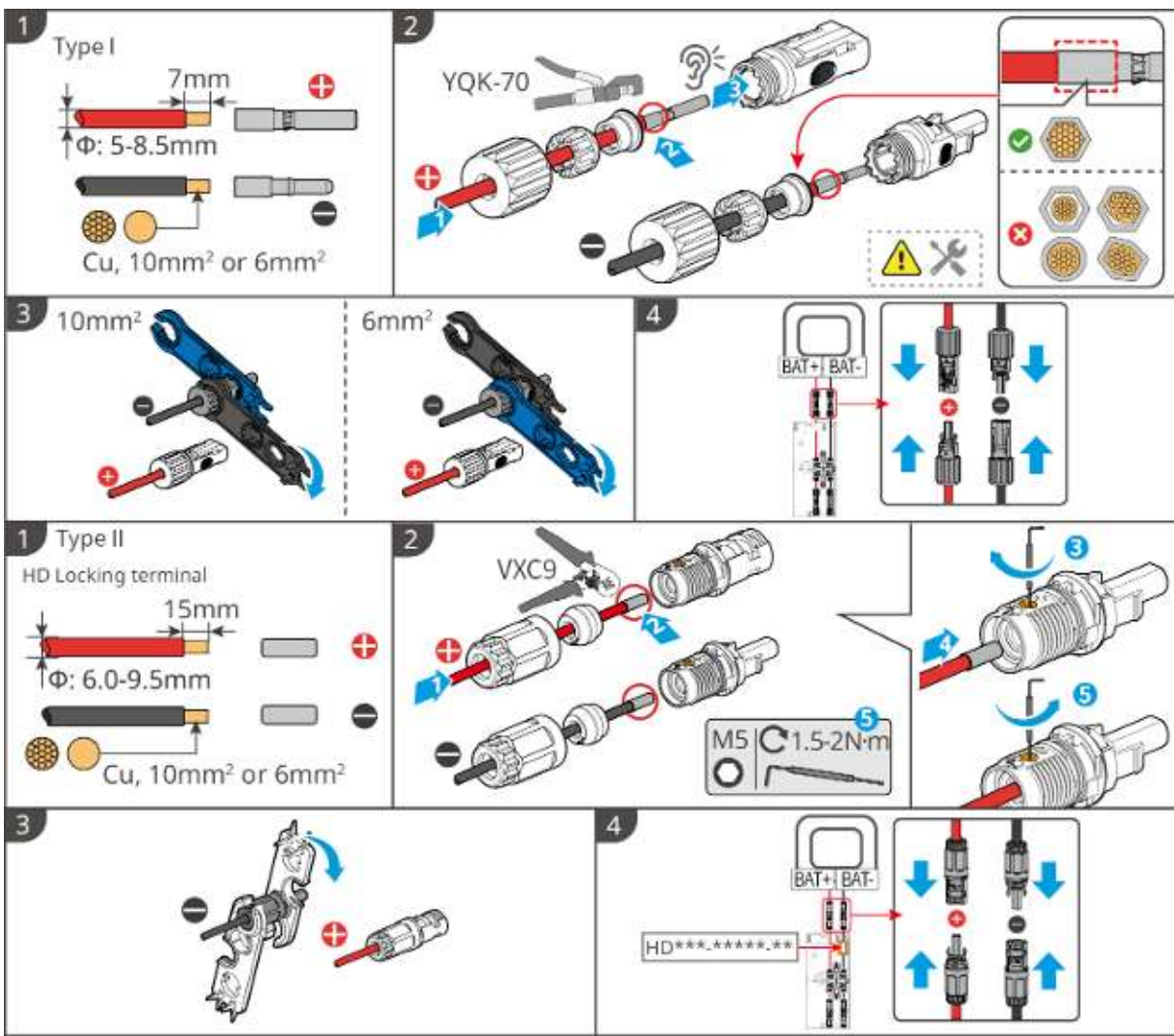

6.6.2 Connecting the Communication Cable Between the Inverter and Battery

NOTICE

The BMS cable is included in the package of the inverter, the included BMS communication cable is recommended. If more communication cables are needed, prepare shielded network cables and RJ connectors by yourself to make the cable.

Inverter + Lynx Home F bat

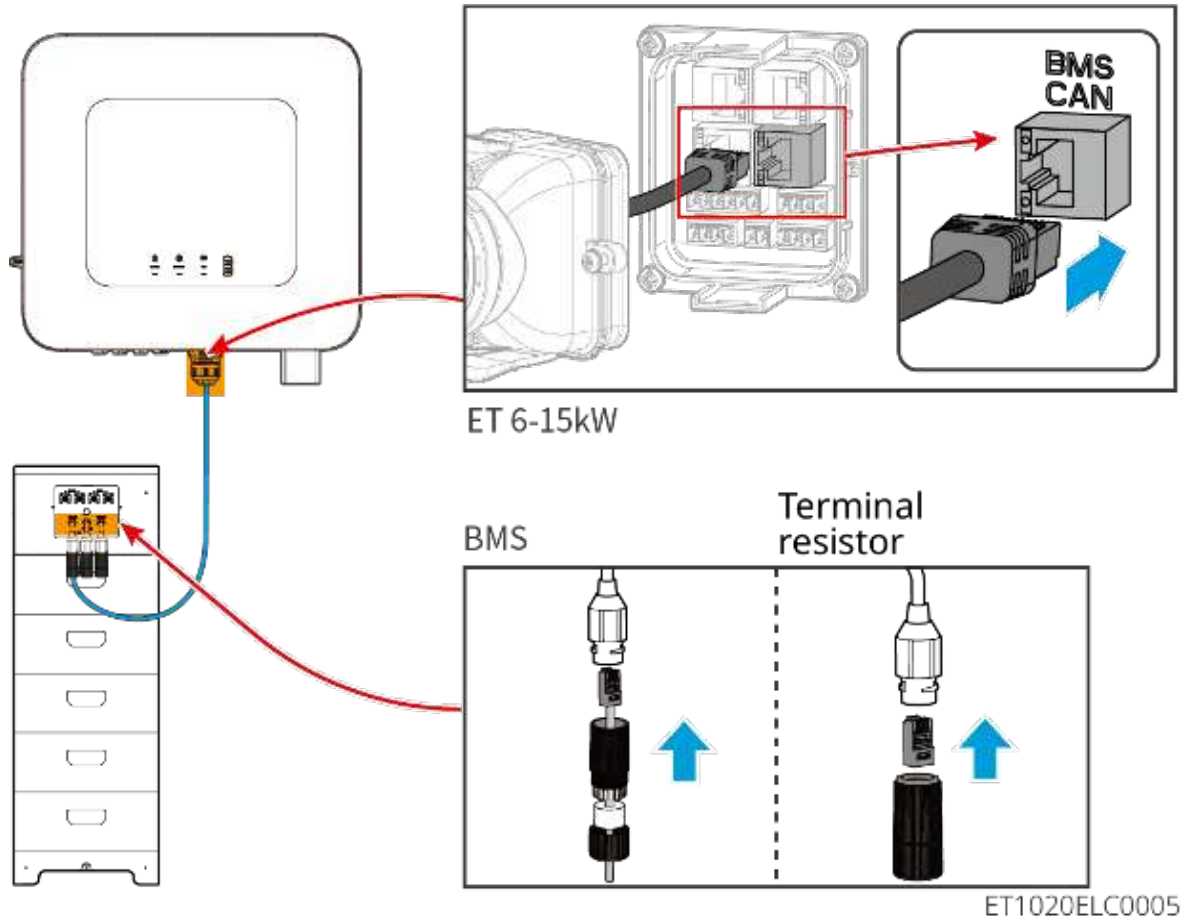

Installing protective cover for Lynx Home F G2 (optional)

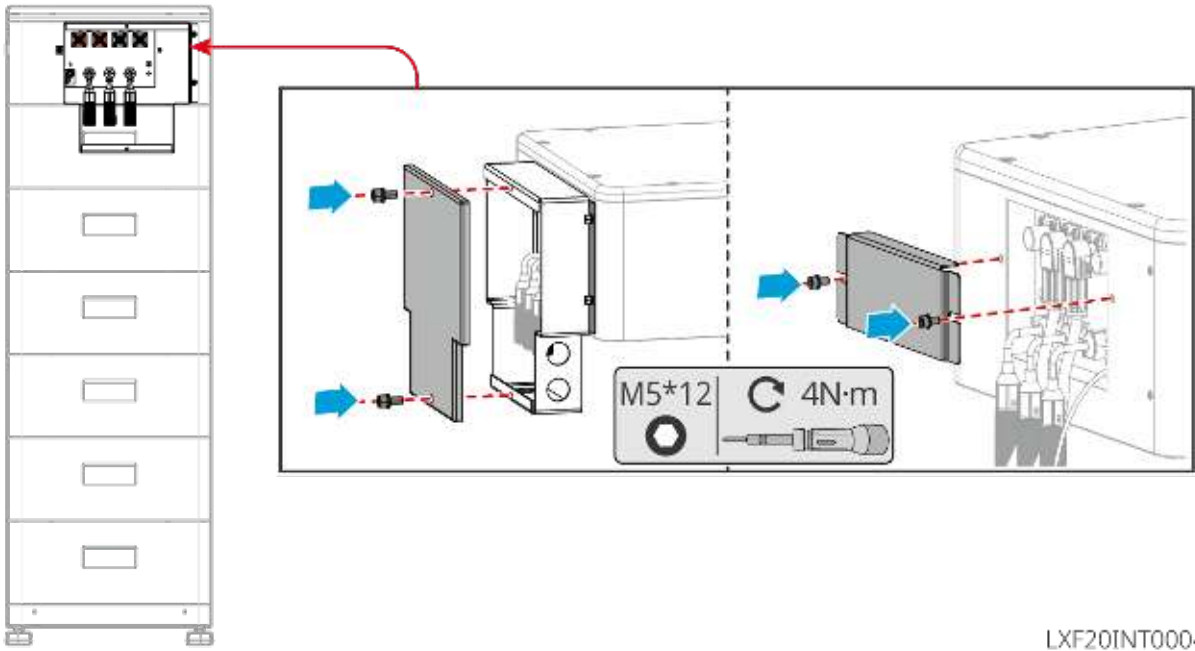

LXF20INT0004

Inverter + Lynx Home D

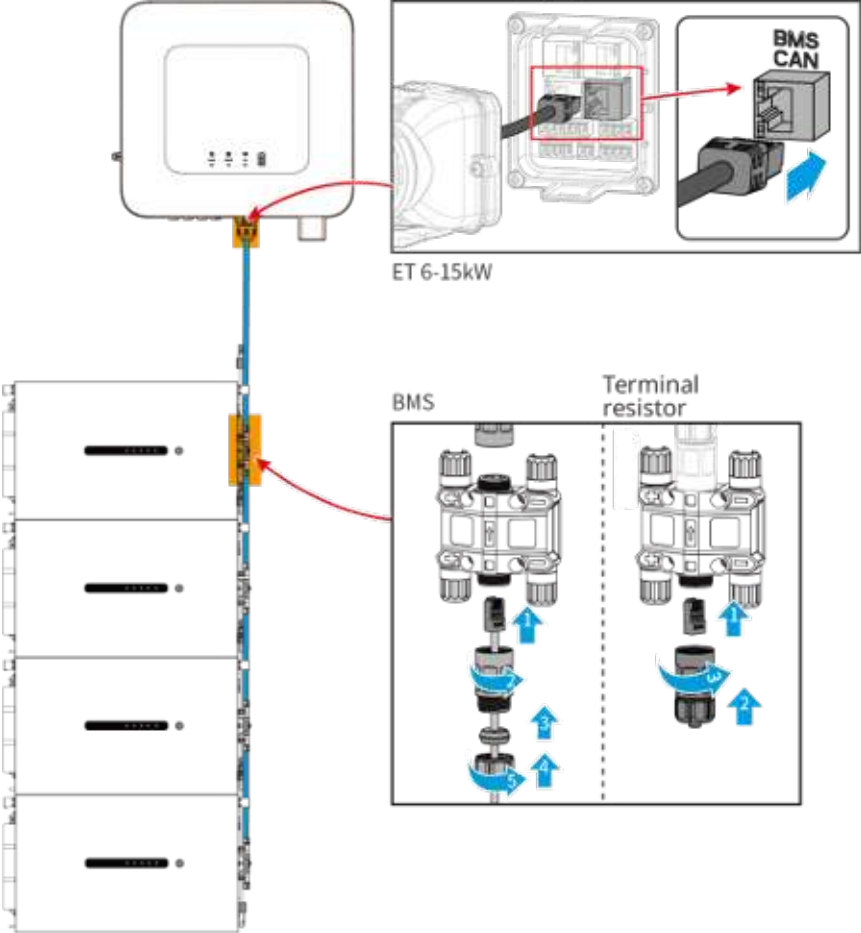

LXD20ELC0011

6.6.3 Connecting the Power Cable and Communication Cable Between Lynx Home D Batteries

6.6.3.1 Power cable

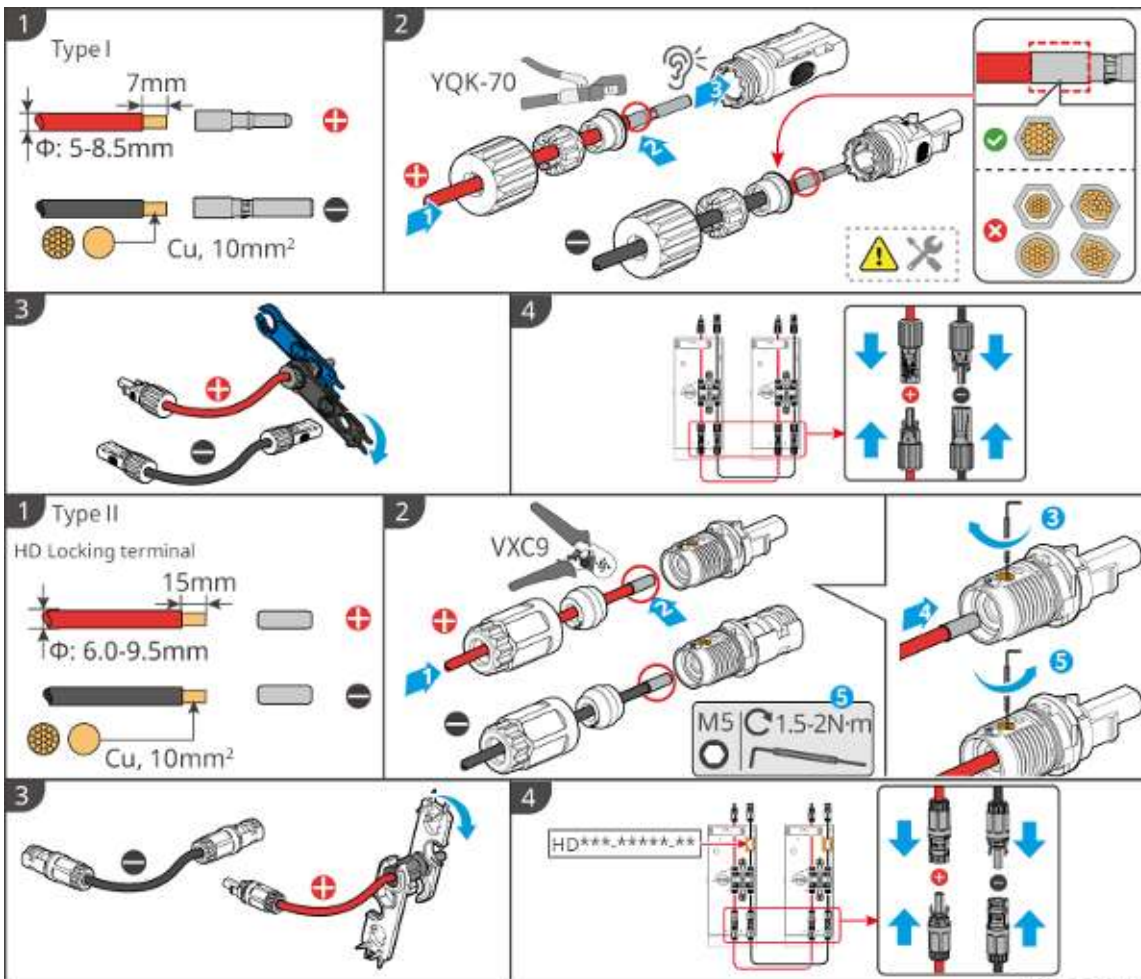

LXD10ELC0002

Connecting the Power cable

Type I

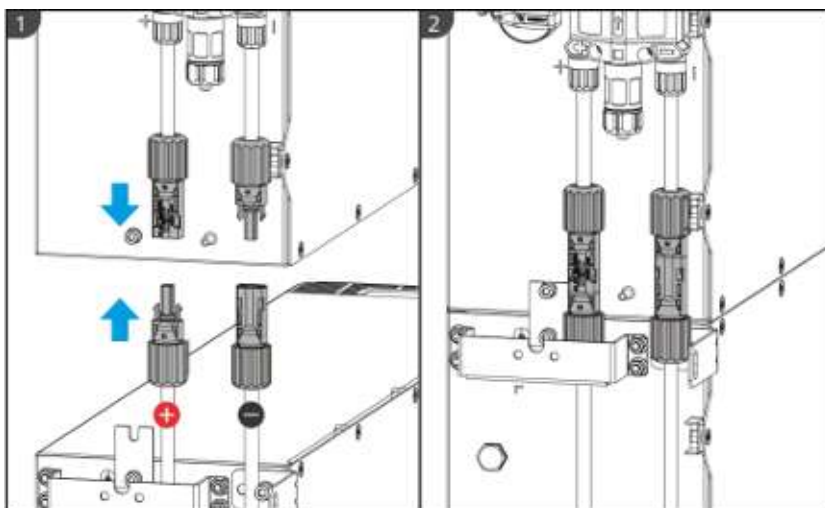

LXD10ELC0006

Type II

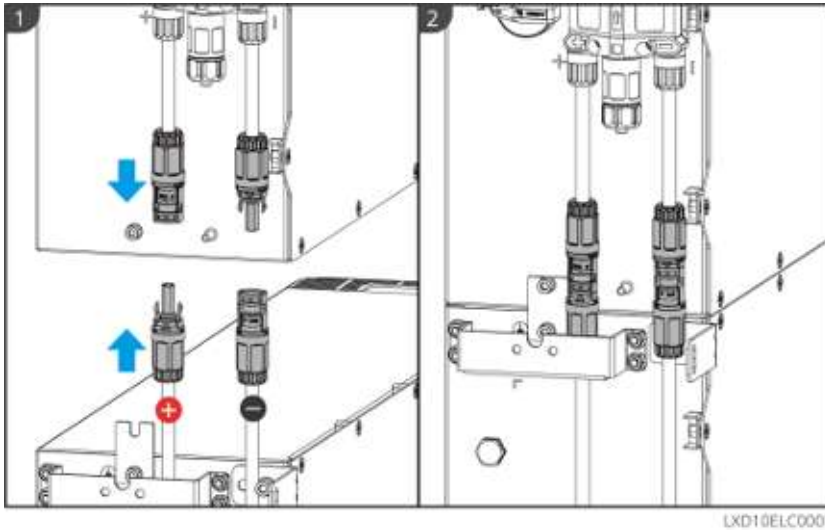

Use the package included tool and follow the steps below to remove the power connector.

Type I

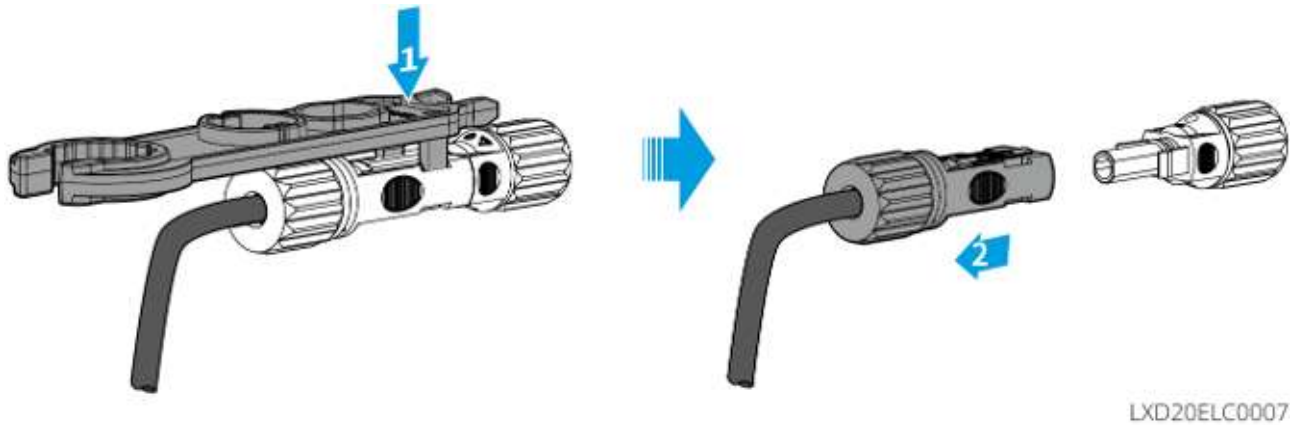

Type II

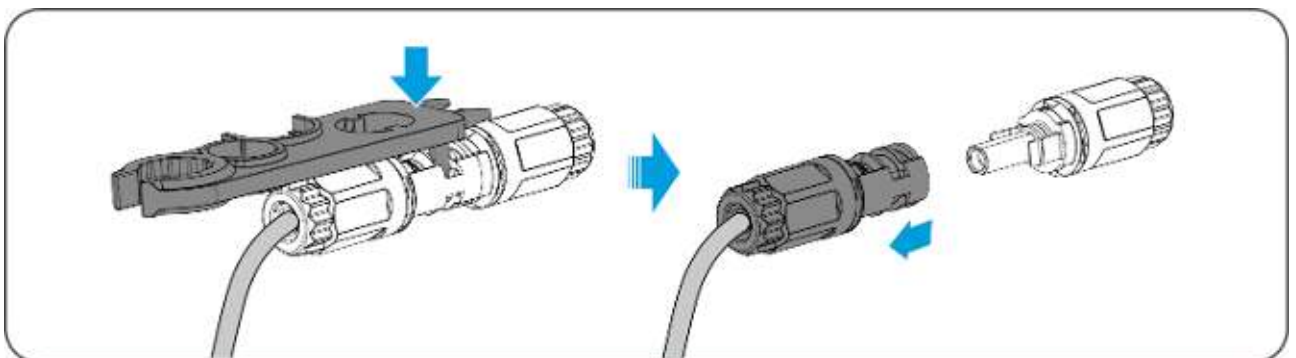

6.6.3.2 Communication Cable and Terminal Resistor

Use the communication cable and terminal resistor included in the package.

WARNING

- Do not forget to install the terminal resistor, otherwise the battery system cannot work properly.
- Do not remove the waterproof plug during installation.

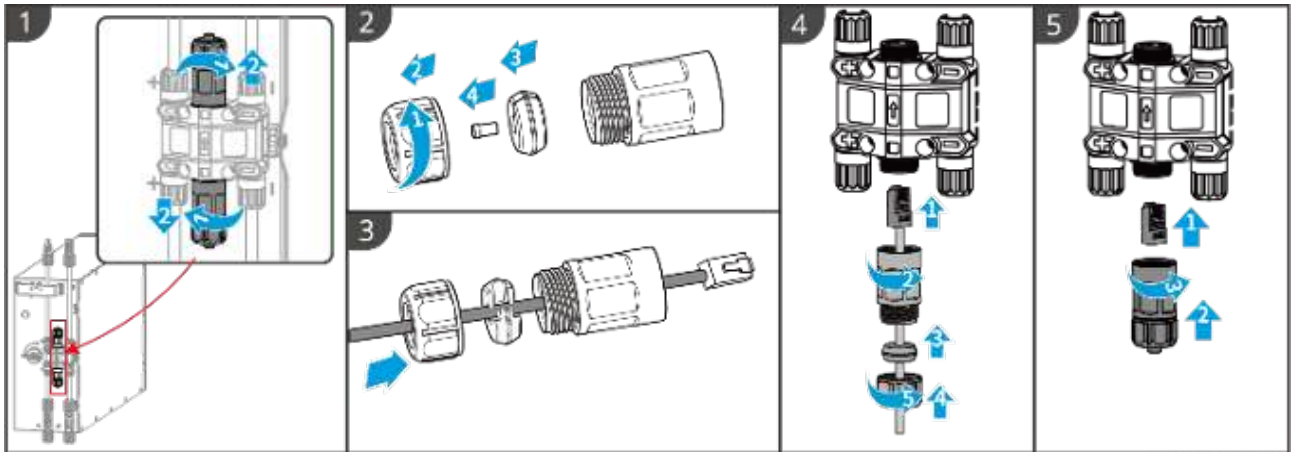

LXD10ELC0008

6.6.3.3 Installing the Protective Cover

NOTICE

Remove the release paper on the back of the protective cover before installing the front protective cover of the rack.

Step 1 (Optional) For ground installation only. If no cable pass through the base, install a hole plug here.

Step 2 Install the side cover of the battery.

Step 3 (Optional) For wall mount installation only. Install the cover of the wall mounting rack.

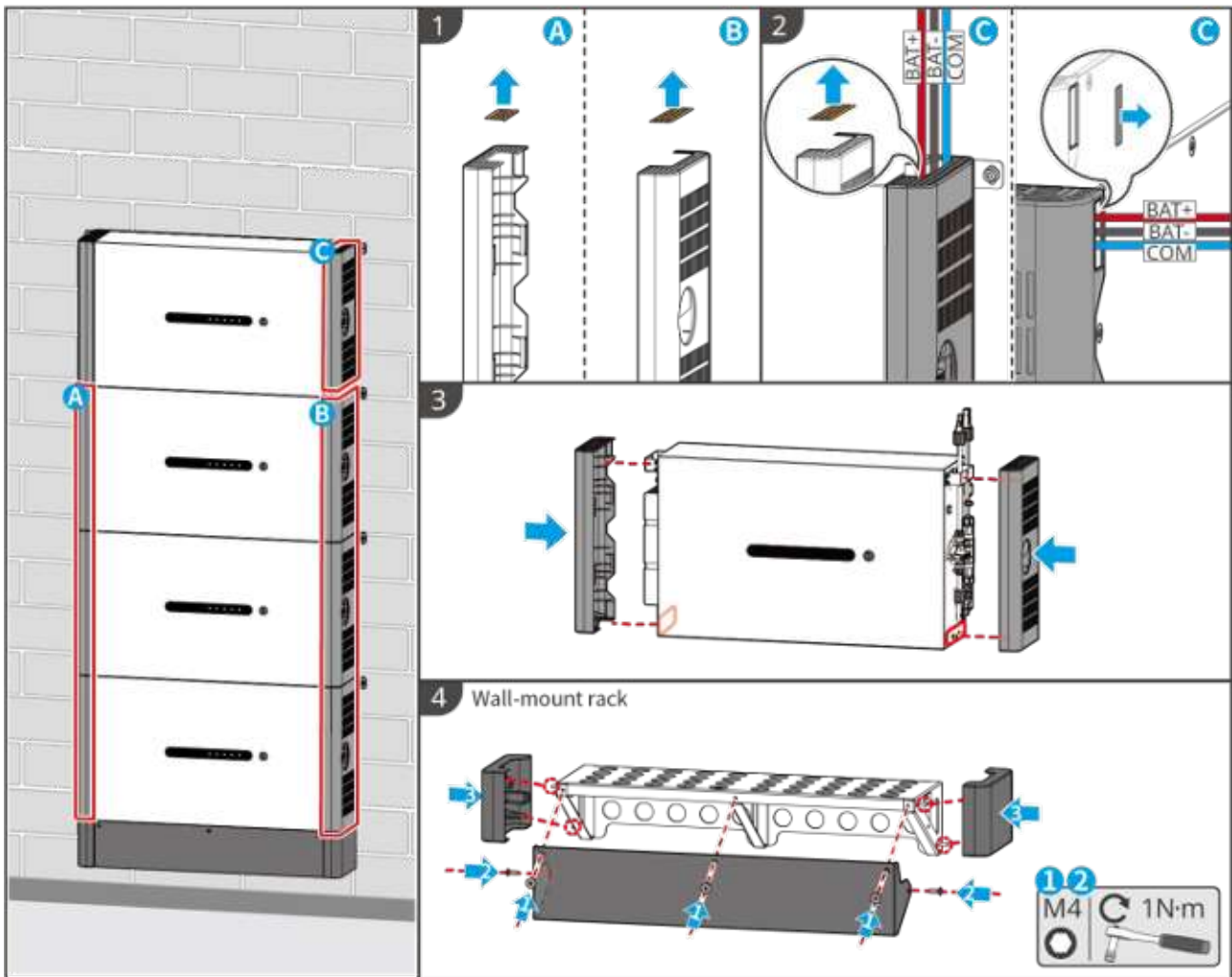

LXD10INT0014

6.7 Connecting the AC Cable

WARNING

- The residual current monitoring unit (RCMU) is integrated into the inverter to avoid the residual current exceeds the limit. The inverter will disconnect the utility grid quickly once it found the residual current exceeds the limit.
- Install one AC output circuit breaker for each inverter. Multiple inverters cannot share one AC circuit breaker.
- An AC circuit breaker shall be installed on the AC side to make sure that the inverter can safely disconnect the grid when an exception happens. Select the appropriate AC circuit breaker in compliance with local laws and regulations.
- When the inverter is powered on, the BACK-UP AC port is energized. Power off the inverter first if maintenance is required on the BACK-UP loads. Otherwise, it may cause electric shock.
- Ensure the AC cables match the AC terminals labeled "L1", "L2", "L3", "N", "PE" when connecting cables. Incorrect cable connections will damage the equipment.
- Ensure that the whole cable cores are inserted into the terminal holes. No part of the cable core can be exposed.
- Ensure that the insulation board is inserted into the AC terminal tightly.
- Ensure that the cables are connected securely. Otherwise it will cause damage to the inverter due to overheat during its operation.
- The type A RCD can be connected to the inverter for protection according to the local laws and regulations. Recommended specifications: ON-GRID RCD: 300mA; BACK-UP RCD: 30mA.

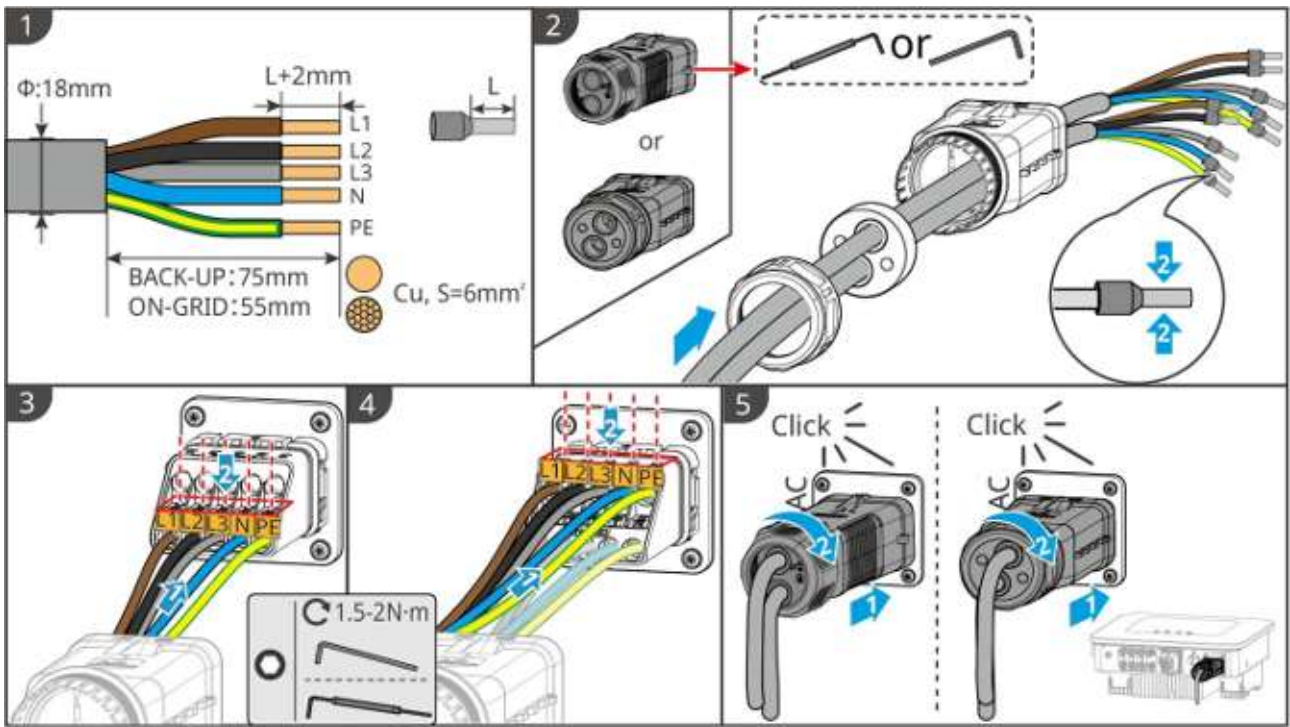

ET1020ELC0006

6.8 Connecting the Meter cable

NOTICE

- The smart meter included in the package is intended for a single inverter. Do not connect one smart meter to multiple inverters. Contact the manufacturer for additional smart meters if multiple inverters are connected.
- Ensure that the CT is connected in the correct direction and phase sequences, otherwise the monitoring data will be incorrect.
- Ensure the cables are connected tightly, securely and correctly. Inappropriate wiring may cause poor contacts and damage the equipment.
- In areas at risk of lightning, if the meter cable exceeds 10m and the cables are not wired with grounded metal conduits, you are recommended to use an external lightning protection device.

Wiring of GM3000

NOTICE

- Outer diameter of the AC cable should be smaller than the hole diameter of the CT, so that the AC cable can be routed through the CT.
- To ensure accurate current detection, the CT cable is recommended to be shorter than 30m.
- Do not use network cable as the CT cable, otherwise the smart meter may be damaged due to high current.
- The CTs vary slightly in dimensions and appearance depending on the model, but they are installed and connected in the same way.

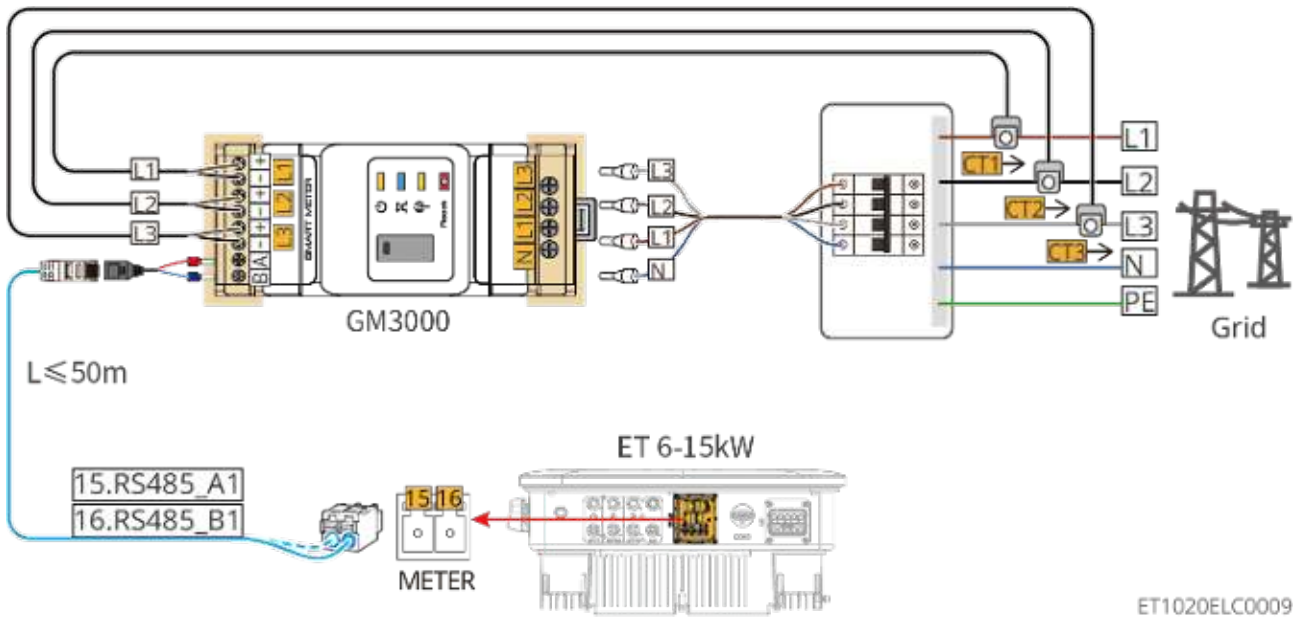

Connection steps

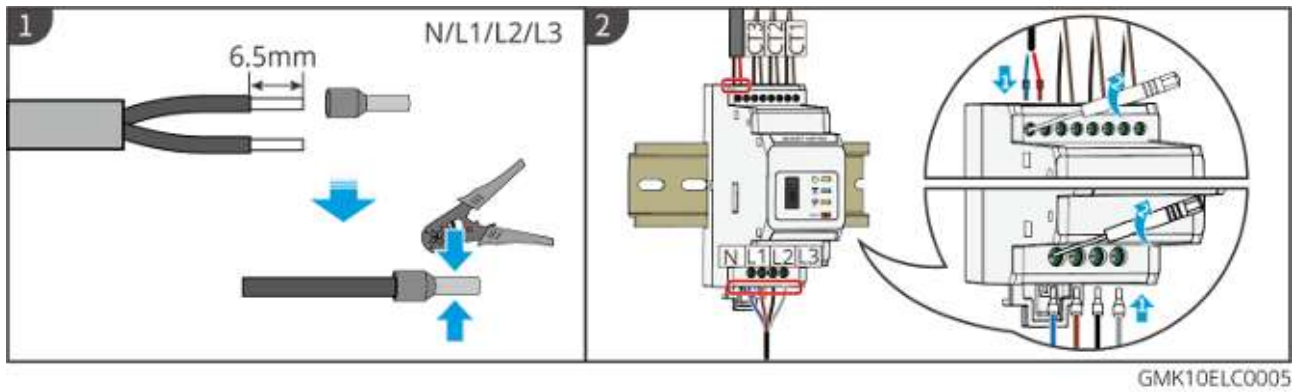

Wiring of GM330

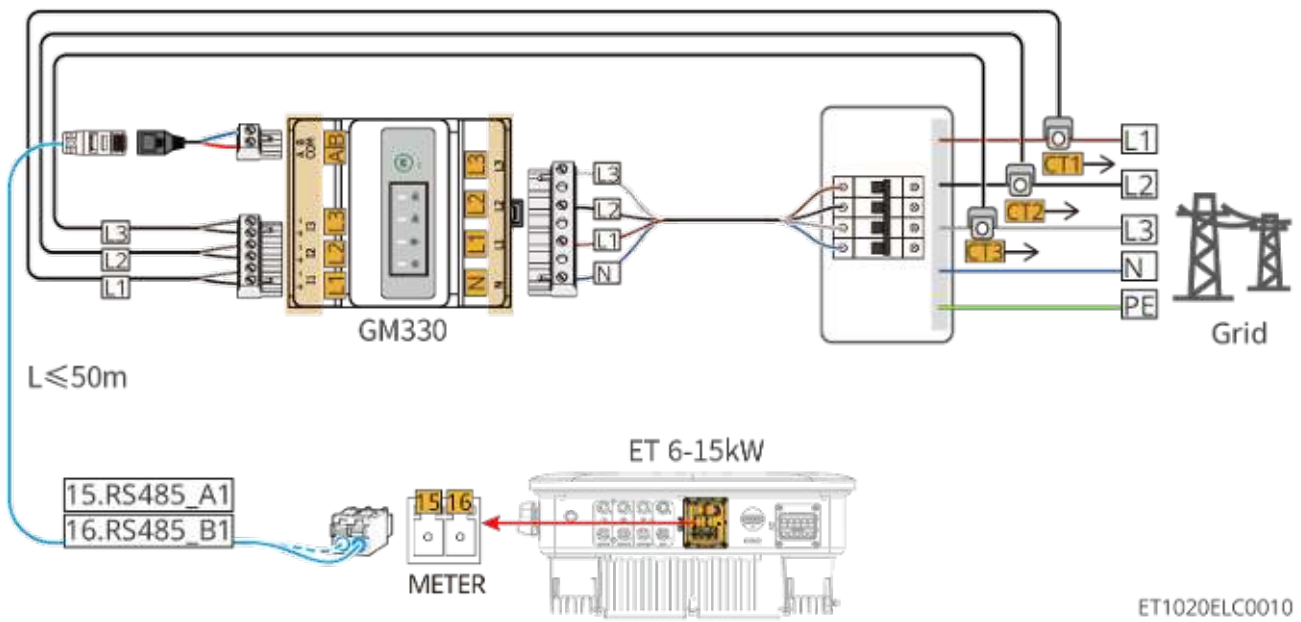

Connection steps

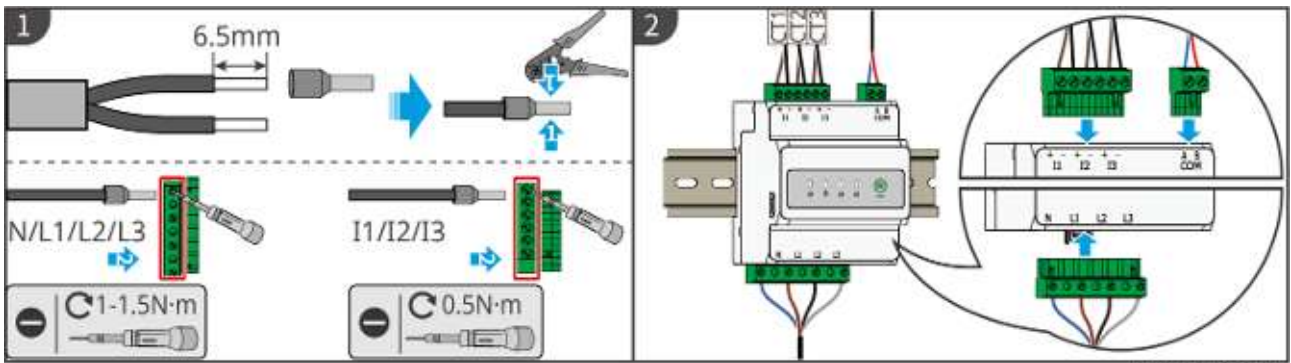

GMK10ELC0004

Installing the CT (Type I)

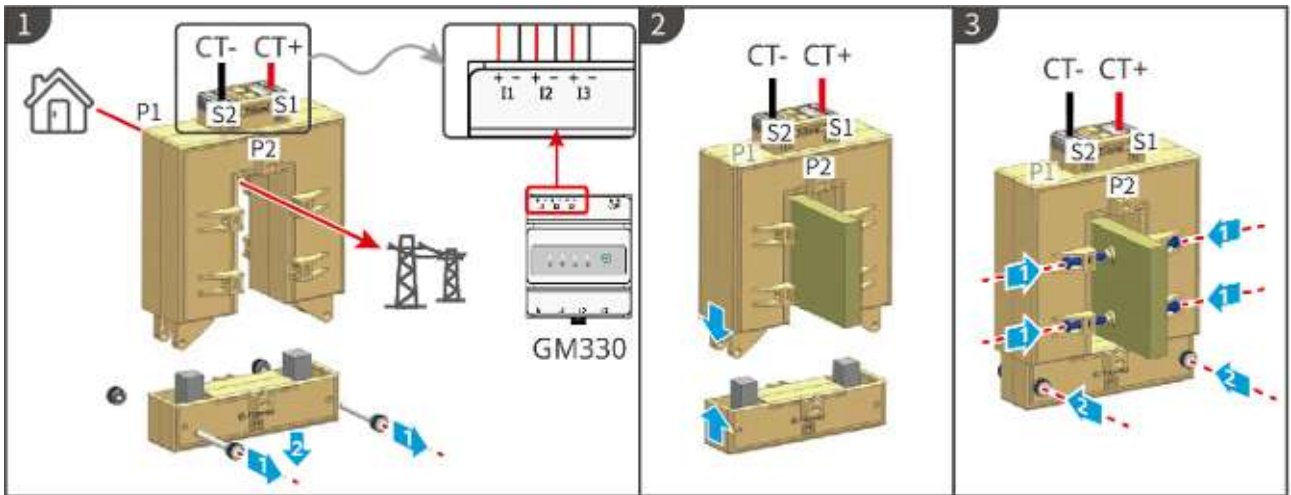

GMK10ELC0006

Installing the CT (Type II)

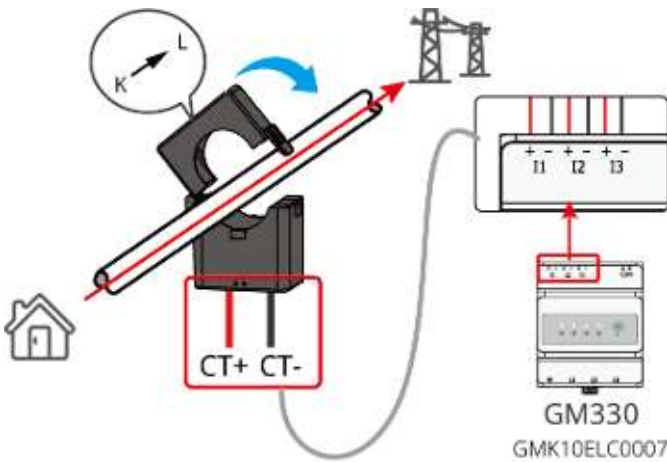

GMK10ELC0007

6.9 Connecting the Inverter Communication Cable

NOTICE

- If the built-in smart meter is used in the parallel scenario, the CT must be connected to the master inverter. Do not connect any CT to the slave inverters.
- Use the delivered CT when using the built-in smart meter.
- The communication functions are optional. Connect the cables based on actual needs.
- Enable the DRED, RCR or remote shutdown function via SolarGo App after cable connections.
- If the inverter is not connected to the DRED device or remote shutdown device, do not enable these functions in the SolarGo App, otherwise the inverter cannot be connected to the grid for

operation.

- To realize DRED or RCR function in parallel scenarios, the communication cable have to be connected to the master inverter. To realize remote shutdown function in parallel scenarios, the communication cables have to be connected to all inverters.
- Signals connected to the DO communication port of the inverter should meet the specifications: Max≤24Vdc, 1A.
- EMS communication port: connects with the third party device. The third party EMS device is not supported in a parallel system.
- To ensure good communication quality, connect the PAR1 port of one inverter to the PAR2 port of the other inverter. Do not connect the PAR1 ports of two inverters together.
- To ensure waterproof protection, do not remove the waterproof seal of the unused ports.
- Recommended parallel communication cable length: CAT 5E or CAT 6E shielded Ethernet cables ≤5m; CAT 7E shielded Ethernet cables ≤10m. Ensure that the parallel communication cable does not exceed 10m, otherwise the communication may be abnormal.
- After the wiring of the parallel system is completed, the DIP switch of the first and last inverters needs to be turned to the ON position, and other inverters need to be turned to the 1 position.
- The DIP switch for parallel system is set to the ON position by default when leaving the factory.
- To use the EnWG 14a, please ensure that the ARM software version is 13.435 or above, and the SolarGo version is 6.0.0 or above.

Communication Descriptions

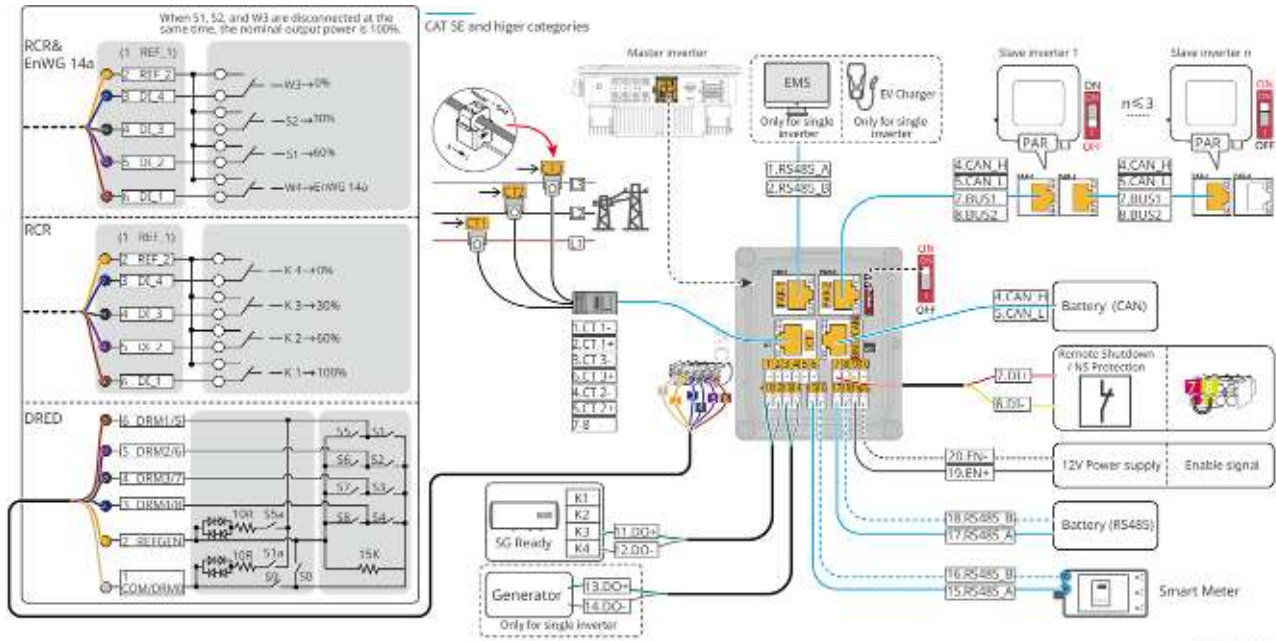

No.	Function	Description
1-6	DRED/RCR or EnWG 14a port (DRED/RCR/ EnWG 14a)	<ul style="list-style-type: none"> ● RCR (Ripple Control Receiver): the inverter satisfies Germany RCR certification and offers RCR signal controlling ports. ● DRED (Demand Response Enabling Device): the inverter satisfies the Australian DERD certification and offers DRED signal controlling ports. ● EnWG (Energy Industry Act) 14a: All controllable loads need to accept the emergency dimming of the grid. Grid operators can reduce the maximum grid purchasable power of controllable loads to 4.2kW temporarily.

7-8	Remote shutdown/NS Protection (RSD)	<p>Provides signal control port to control equipment remote shutdown or realize NS protection function.</p> <p>Remote shutdown function:</p> <ul style="list-style-type: none"> ● Control the device and stop it once any accident happens. ● Remote shutdown devices must be normally closed switches. ● Before enabling RCR or DRED function, ensure that the remote shutdown device is connected or the remote shutdown port is short-circuited.
11-12	Load control (LOAD CNTL)	<ul style="list-style-type: none"> ● Supports connecting to dry contact signals to realize functions such as load control. Switching capacity of DO is 12V DC@1A. NO/COM is the normally open contact. ● Supports SG Ready heat pump, which can be controlled by the dry contact signal. ● Supported working mode: <ul style="list-style-type: none"> ○ Working mode 2 (signal: 0:0): energy saving mode, the heat pump works in energy saving mode. ○ Working mode 3(signal: 0:1): the heat pump stores more hot water while working in the existing operation.
13-14	Generator start/stop control port (GEN)	<ul style="list-style-type: none"> ● Supports generator controlling signal. ● Do not connect the power cable of the generator to the AC port of the inverter.
15-16	Meter port (Meter)	Connect the external smart meter through RS485 communication.
17-18	Battery RS485 communication port (BMS)	RS485 communication port of the battery system.
19-20	Battery enable communication port or 12V power supply port (EN)	Output battery enable signal or supply 12V DC power to external fans.
PAR-1	<ul style="list-style-type: none"> ● Parallel communication port ● EMS communication/charging post communication port 	<ul style="list-style-type: none"> ● CAN and BUS port: parallel communication port. In parallel scenarios, inverters communicate through CAN, and switch on-grid or off-grid status of the inverters through BUS. ● RS485 Port: used to connect third-party EMS equipment and charging pile. The connection of third-party EMS devices and charging piles is not supported in the parallel scenario
PAR-2	Parallel communication port	<ul style="list-style-type: none"> ● CAN and BUS port: parallel communication port. In parallel scenarios, inverters communicate through CAN, and switch on-grid or off-grid status of the inverters through BUS.
BMS /CAN	Battery CAN communication port (BMS CAN)	CAN communication port of the battery system.
CT	CT port (CT)	Only for the built-in smart meter of the inverter.
-	DIP switch for parallel system	In parallel scenarios, set the DIP switches of the first and last inverters to ON and the other inverters to 1.

Connecting the communication cable

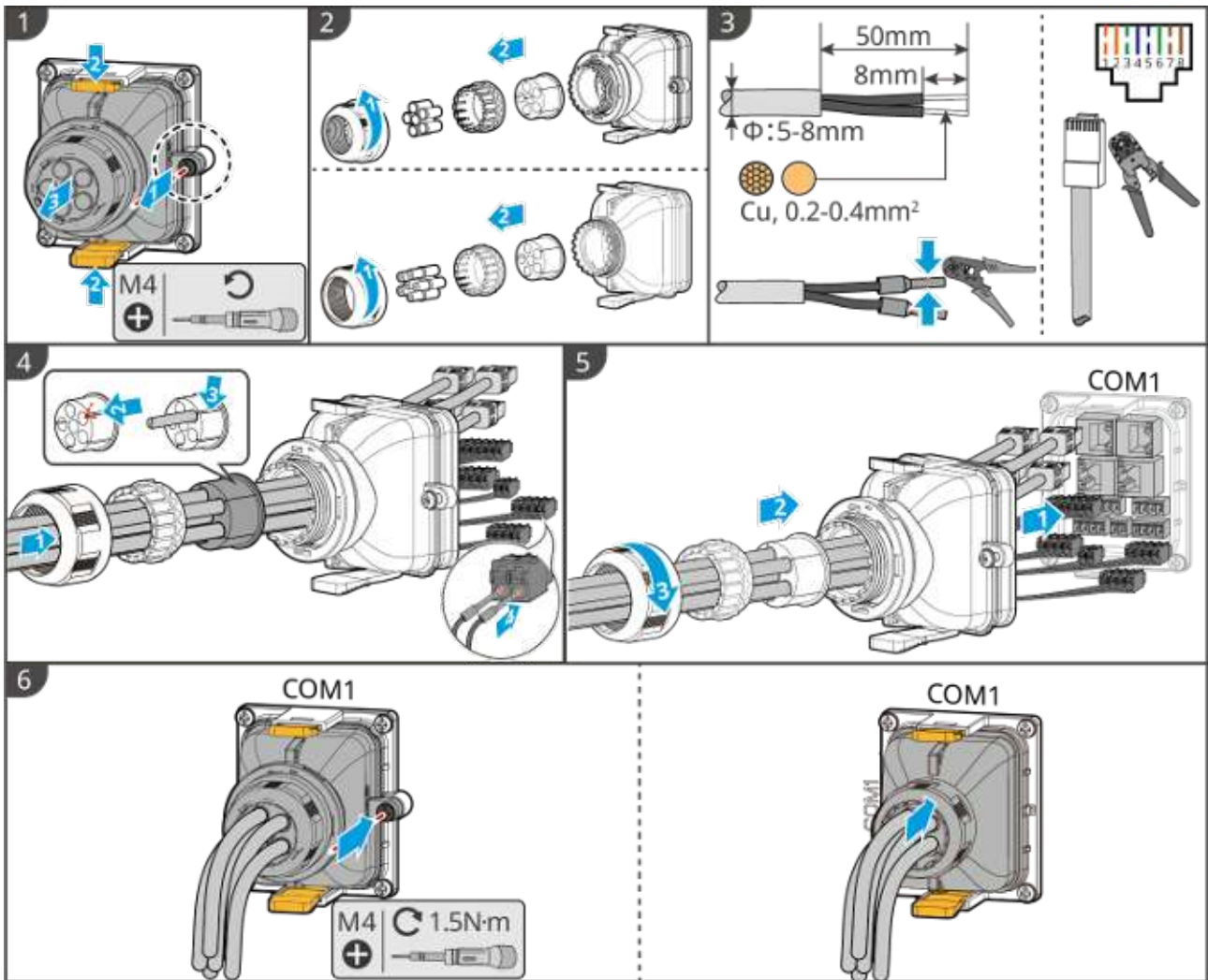

ET1020ELC007

6.10 Connecting the Smart Dongle

NOTICE	
<ul style="list-style-type: none"> ● Plug a smart dongle into the inverter to establish a connection between the inverter and the smartphone or web pages through Bluetooth, WiFi or LAN. Set inverter parameters, check running information and fault information, and observe system status in time via the smartphone or web pages. ● When multiple inverters are connected in a parallel system, the Ezlink3000 should be installed to the master inverter. ● WiFi/LAN Kit-20 or 4G can be used when there is only one inverter. ● Install a WiFi/LAN Kit-20 or Ezlink3000 when the inverter is connected to the router through WiFi or LAN. ● When 4G communication is selected to upload the operation information of the energy storage system to the monitoring platform, LS4G Kit-CN, 4G Kit-CN, 4G Kit-CN-G20 or 4G Kit-CN-G21 can be used. When using LS4G Kit-CN or 4G Kit-CN, you need to use the smart dongle delivered with the inverter to configure the parameters of the energy storage system. After the configuration is completed, replace it with LS4G Kit-CN or 4G Kit-CN for data transmission. When using 4G Kit-CN-G20 or 4G Kit-CN-G21, please use the emitted Bluetooth signal to configure the near-end device. ● The 4G dongle is a LTE single-antenna device, applicable to scenarios with low data 	

transmission rate requirements.

- The built-in SIM card of the 4G smart dongle is a mobile communication card. Please confirm whether the device is installed in an area covered by mobile 4G signals.
- The 4G Kit-CN-G20 or 4G Kit-CN-G21 smart dongle supports the replacement of operator communication cards. If the local mobile signal is not covered, please contact the after-sales service center to replace it with a communication card of another operator.
- After installing the 4G Kit-CN-G20 or 4G Kit-CN-G21, contact the after-sales service center to bind the inverter and the smart dongle. After binding, if you need to install the dongle to other inverters, please contact the after-sales service center to unbind it first.
- To ensure the quality of 4G signal communication, do not install the device indoors or in areas with signal interference of metal.

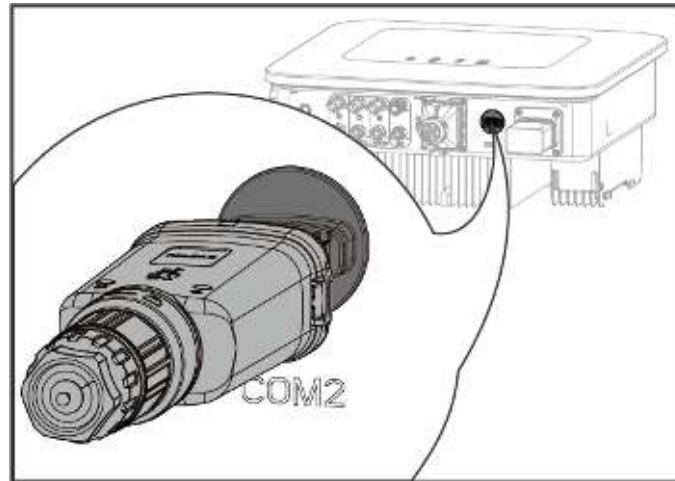

ET1020NET0008

7 System Commissioning

7.1 Check Before Power ON

No.	Port definition
1	The inverter is firmly installed in a clean place where is well-ventilated and easy to operate.
2	The PE, DC input, AC output, communication cables, and terminal resistors are connected correctly and securely.
3	Cable ties are intact, routed properly and evenly.
4	Unused cable holes are fitted using the waterproof nuts.
5	The used cable holes are sealed.
6	The voltage and frequency at the connection point meet the inverter grid connection requirements.

7.2 Power ON

⚠ WARNING

When power on the parallel system, make sure that all the AC breakers of the slave inverters are powered on within one minute after powering on the AC breaker of the master inverter.

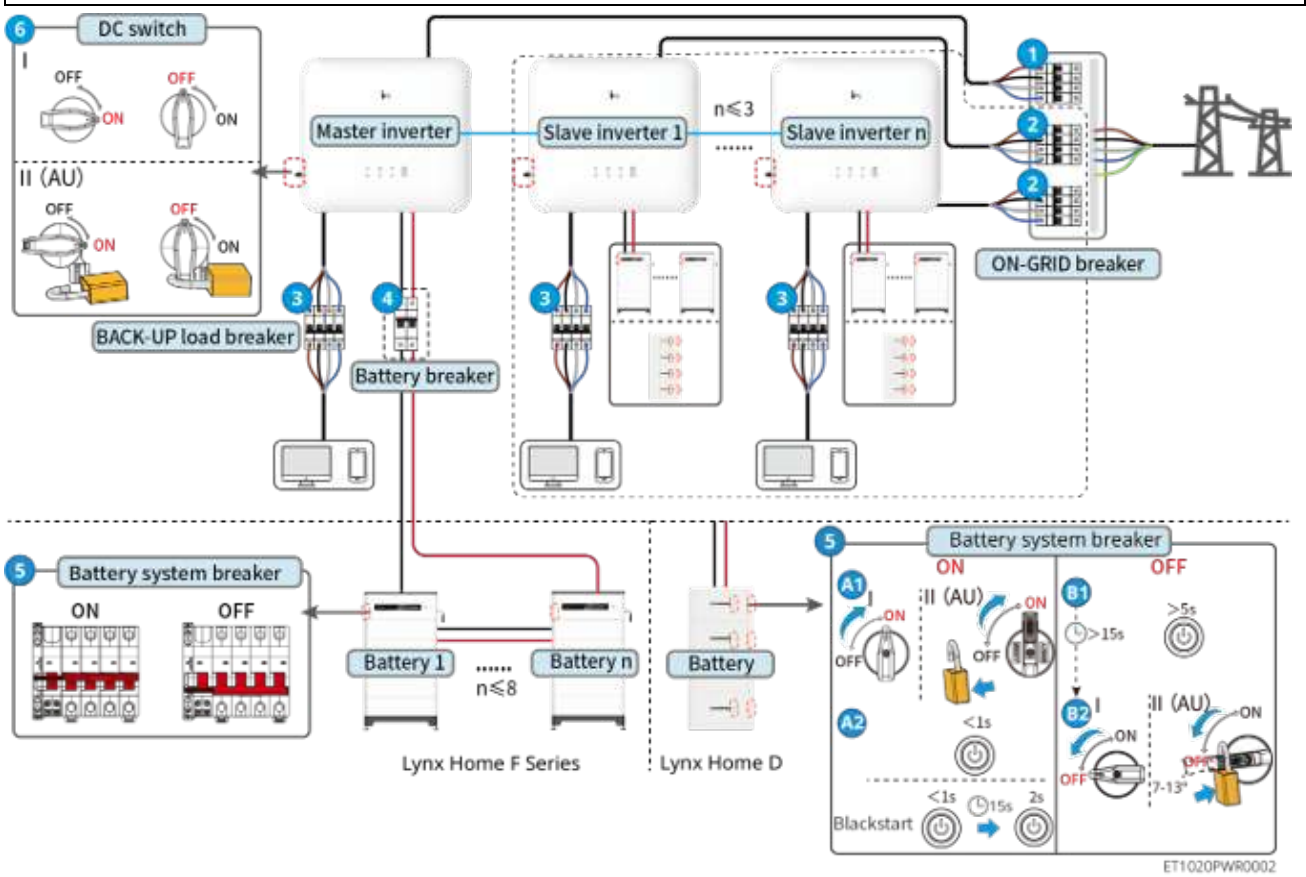





















Power ON/OFF: ① → ② → ③ → ④ → ⑤ → ⑥



④ : Optional in compliance with local laws and regulations.

7.3 Indicators

7.3.1 Inverter Indicators

Indicator	Status	Description
		The inverter is power on and in the standby mode.
		The inverter is starting up and in the self-check mode.
		The inverter is in normal operation under grid-tied or off-grid mode.
		BACK-UP output overload.
		System fault.
		The inverter is powered off.
		The grid is abnormal, and the power supply to the BACK-UP port of the inverter is normal.
		The grid is normal, and the power supply to the BACK-UP port of the inverter is normal.
		The BACK-UP port has no power supply.
		The monitoring module of the inverter is resetting.
		The inverter fails to connect with the communication Termination.
		Communication fault between the communication Termination and Server.
		The monitoring of the inverter operates well.
		The monitoring module of the inverter has not been started yet.

Indicator	Description
	75% < SOC ≤ 100%
	50% < SOC ≤ 75%
	25% < SOC ≤ 50%







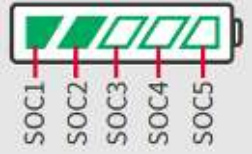

	$0% < \text{SOC} \leq 25\%$
	No battery connected.
Indicator light blinking during battery discharging: for example, when the battery SOC is between 25% and 50%, the light at the 50% position blinks.	

7.3.2 Battery Indicators

Lynx Home F Series



Normal status



SOC indicator	Button indicator	Battery system status
 <p>SOC indicator indicates the battery percentage of the battery system.</p> <ul style="list-style-type: none">  SOC < 5%  5% ≤ SOC < 25%  25% ≤ SOC < 50%  50% ≤ SOC < 75%  75% ≤ SOC < 95%  95% ≤ SOC ≤ 100% 	 <p>Green light blinks 1 time/s</p>	<p>The battery system is in standby mode.</p>
	<p>Green light blinks 2 time/s</p>	<p>The battery system is in idle mode.</p>
	<p>Green light steady on</p>	<p>The battery system is charging. Notice: When the battery SOC reaches the charging cutoff SOC, the battery will stop charging.</p>
<p>The last SOC indicator blinks 1 time/s.</p> <ul style="list-style-type: none"> ● When 5% ≤ SOC < 25%, SOC 1 blinks. ● When 25% ≤ SOC < 50%, SOC 2 blinks. ● When 50% ≤ SOC < 75%, SOC 3 blinks. ● When 75% ≤ SOC < 95%, SOC 4 blinks. ● When 95% ≤ SOC ≤ 100%, SOC 5 blinks. 	<p>Green light steady on</p>	<p>The battery system is in discharging status. Note: When the system does not need to supply power to the load or the battery SOC is below the set discharge depth, the battery will no longer discharge. When the battery SOC is below the set depth of discharge, the battery will no longer discharge.</p>

Abnormal status

Button indicator 	Battery system status	Description
Red light blink 1 time/s	Battery system alarm	Once an alarm occurs, the battery system will perform a self-check. After the battery system self-check is complete, the battery system enters operation or fault mode.
Red light steady on	Battery system fault	Check both the button indicator and the SOC indicator status to determine the fault that has occurred and handle the problem follow the methods recommended in the Troubleshooting section.

Lynx Home D

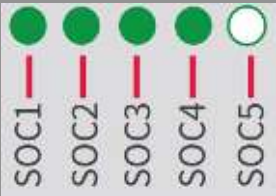
Normal status

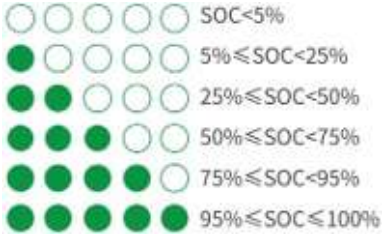

SOC indicator 	Button indicator 	Battery system status
SOC indicator indicates the battery percentage of the battery system.  <ul style="list-style-type: none"> ○ ○ ○ ○ ○ SOC < 5% ● ○ ○ ○ ○ 5% ≤ SOC < 25% ● ● ○ ○ ○ 25% ≤ SOC < 50% ● ● ● ○ ○ 50% ≤ SOC < 75% ● ● ● ● ○ 75% ≤ SOC < 95% ● ● ● ● ● 95% ≤ SOC ≤ 100% 	Green light blinks	The battery system is in standby mode.
	Green light steady on	The battery system is charging. Notice: When the battery SOC reaches the charging cutoff SOC, the battery will stop charging.
The last SOC indicator blinks 1 time/s. <ul style="list-style-type: none"> ● When 5% ≤ SOC < 25%, SOC 1 blinks. ● When 25% ≤ SOC < 50%, SOC 2 blinks. ● When 50% ≤ SOC < 75%, SOC 3 blinks. ● When 75% ≤ SOC < 95%, SOC 4 blinks. ● When 95% ≤ SOC ≤ 100%, SOC 5 blinks. 	Green light steady on	The battery system is in discharging status. Note: When the system does not need to supply power to the load or the battery SOC is below the set discharge depth, the battery will no longer discharge. When the battery SOC is below the set depth of discharge, the battery will no longer discharge.





Abnormal status

Button indicator 	Battery system status	Description
Red light blinks	Battery system alarm	Once an alarm occurs, the battery system will perform a self-check. After the battery system self-check is complete, the battery system enters operation or fault mode. Check the alarm information through the SolarGo app.
Red light steady on	Battery system fault	Check both the button indicator and the SOC indicator status or SolarGo app to determine the fault that has occurred and handle the problem follow the methods recommended in the Troubleshooting section.

7.3.3 Smart Meter Indicator

GM3000











Type	Status	Description
Power 	Steady on	The smart meter is power on.
	Off	The smart meter is power off.
Importing or exporting indicator 	Steady on	Importing from the grid.
	Blinks	Exporting to the grid.
COM 	Blinks	Communication is OK.
	Blinking 5 times	<ul style="list-style-type: none"> ● Press the Reset button for less than 3 seconds: Reset the meter. ● Press the Reset button for 5 seconds: Reset the meter parameters to factory settings. ● Press the Reset button for more than 10 seconds: Reset the meter parameters to factory settings, and reset the energy data to zero.
	Off	Meter has no communication connection.

Type	Status	Description
Power 	Steady on	Power on, no RS485 communication.
	Blinks	Power on, RS485 communication works properly.
	Off	The smart meter is power off.
COM 	Off	Reserved
	Blinks	Press the Reset button for more than 5 seconds, power light, buying or selling electricity indicator light flash: Reset the meter.
Importing or exporting indicator 	Steady on	Importing from the grid.
	Blinks	Exporting to the grid.
	Off	Exporting to the grid.
	Reserved	

7.3.4 Smart Dongle Indicator



WiFi/LAN Kit-20

NOTICE
<ul style="list-style-type: none"> ● Double click the Reload button to turn on the bluetooth signal, and the indicator turns to single flash. Connect to the SolarGo app within 5 minutes, or Bluetooth will automatically turn off. ● The indicator only turns to single flash after double clicking the Reload button.

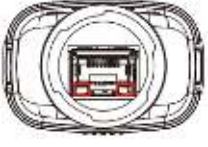



Indicator	Status	Description
Power 		Steady on The smart dongle is powered on.
		Off: The smart dongle is powered off.
COM 		Steady on The WiFi or LAN communication is working well.
		Single blink The Bluetooth signal is on and waiting for connection to the app.
		Double blinks The Smart Dongle is not connected to the router.
		Four blinks The Smart Dongle is communicating with the router but not connected to the server.
		Six blinks The smart dongle is identifying the connected device.
		Off: The software of the Smart Dongle is in reset or not powered on.



Indicator	Color	Status	Description
Communication indicator in LAN Port 	Green	Steady on	The connection of the wired network at 100Mbps is normal.
		Off	<ul style="list-style-type: none"> ● The Ethernet cable is not connected. ● The connection of the wired network at 100Mbps is abnormal. ● The connection of the wired network at 10Mbps is normal.
	Yellow	Steady on	The connection of the wired network at 10Mbps is normal, but no communication data is received or transmitted.
		Blinks	The communication data is being transmitted or received.
		Off	The Ethernet cable is not connected.

LS4G Kit-CN、 4G Kit-CN

Indicator	Color	Status	Description
Power light 	Green	On	Module is tightened and powered up
		Off	Module not tightened or powered up
Communication indicator 	Blue	Slow flash (0.2 on, 1.8s off)	<ul style="list-style-type: none"> ● Inverter communication light 2 flashes: dialing in, looking for network status ● Inverter communication light 4 flashes: no traffic causing connection to the cloud to fail
		Slow flash (1.8 on, 0.2s off)	<ul style="list-style-type: none"> ● Inverter communication light 2 flashes: dialing success ● Inverter communication light is always on: cloud connection is successful ● Inverter communication light 4 flashes: no traffic causing connection to the cloud to fail
		Fast flash (0.125s on, 0.125s off)	The inverter communicates with the cloud through the module
		0.2s on, 8s off	SIM card not installed or poor SIM card contact





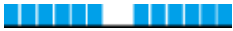
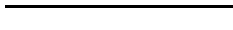

4G Kit-CN-G20 & 4G Kit-CN-G21

Indicator	Status	Description
Power light 		On: The smart dongle has been powered on.
		Power Off: The smart dongle is not powered on.
Communication		On: The smart dongle is communicating normally with the server.

<p>indicator</p> 		Blinks 2 times: Smart dongle is not connected to the base station.
		Blinks 4 times: The smart dongle is connected to the base station, but has not been connected to the server.
		Blinks 6 times: The smart dongle is disconnected from the inverter.
		Off: The software of the smart dongle is resetting or is not powered on.

Button	Description
Reload	Short press for 0.5 to 3 seconds to restart the smart dongle.
	Press and hold for 6 to 20 seconds to restore the Smart Dongle to factory settings.

Ezlink3000

Indicator / silkscreen	Color	Status	Description
Power 	Blue		Blink = The Ezlink is working properly.
			OFF = The Ezlink is powered off.
COM 	Green		ON = The Ezlink is connected to the server.
			Blink 2 = The Ezlink is not connected to the router.
			Blink 4 = The Ezlink is connected to the router, but not connected to the server.
RELOAD	-	-	<ul style="list-style-type: none"> ● Short press for 3s to restart the Ezlink. ● Long press for 3-10s to restore factory settings.

8 Quick System Commissioning

8.1 Downloading the App

Make sure that the mobile phone meets the following requirements:

- Mobile phone operating system: Android 4.3 or later, iOS 9.0 or later.
- The mobile phone can access the Internet.
- The mobile phone supports WLAN or Bluetooth.

Method 1: Search SolarGo in Google Play (Android) or App Store (iOS) to download and install the app.

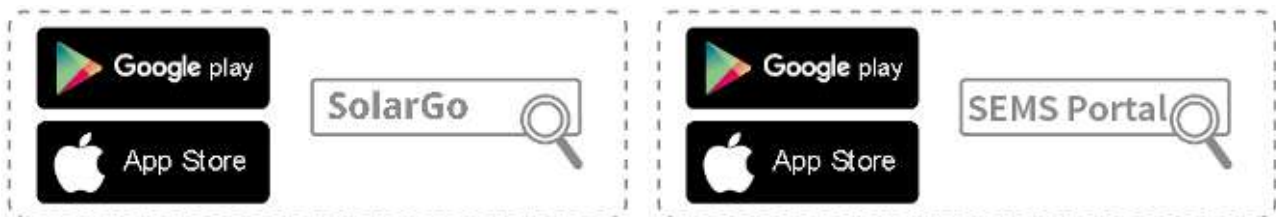

Method 2: Scan the QR code below to download and install the app.



8.2 Connecting the Inverter

NOTICE

The device name varies depending on the inverter model or smart dongle type:

- Wi-Fi Kit: Solar-WiFi***
- Bluetooth module: Solar-BLE***
- WiFi/LAN Kit-20: WLA-***
- Ezlink3000: CCM-BLE***; CCM-***; ***
- 4G Kit-CN-G20 or 4G Kit-CN-G21: GSA-*** or GSB-***

*** is the inverter serial number*

Connecting the inverter via bluetooth

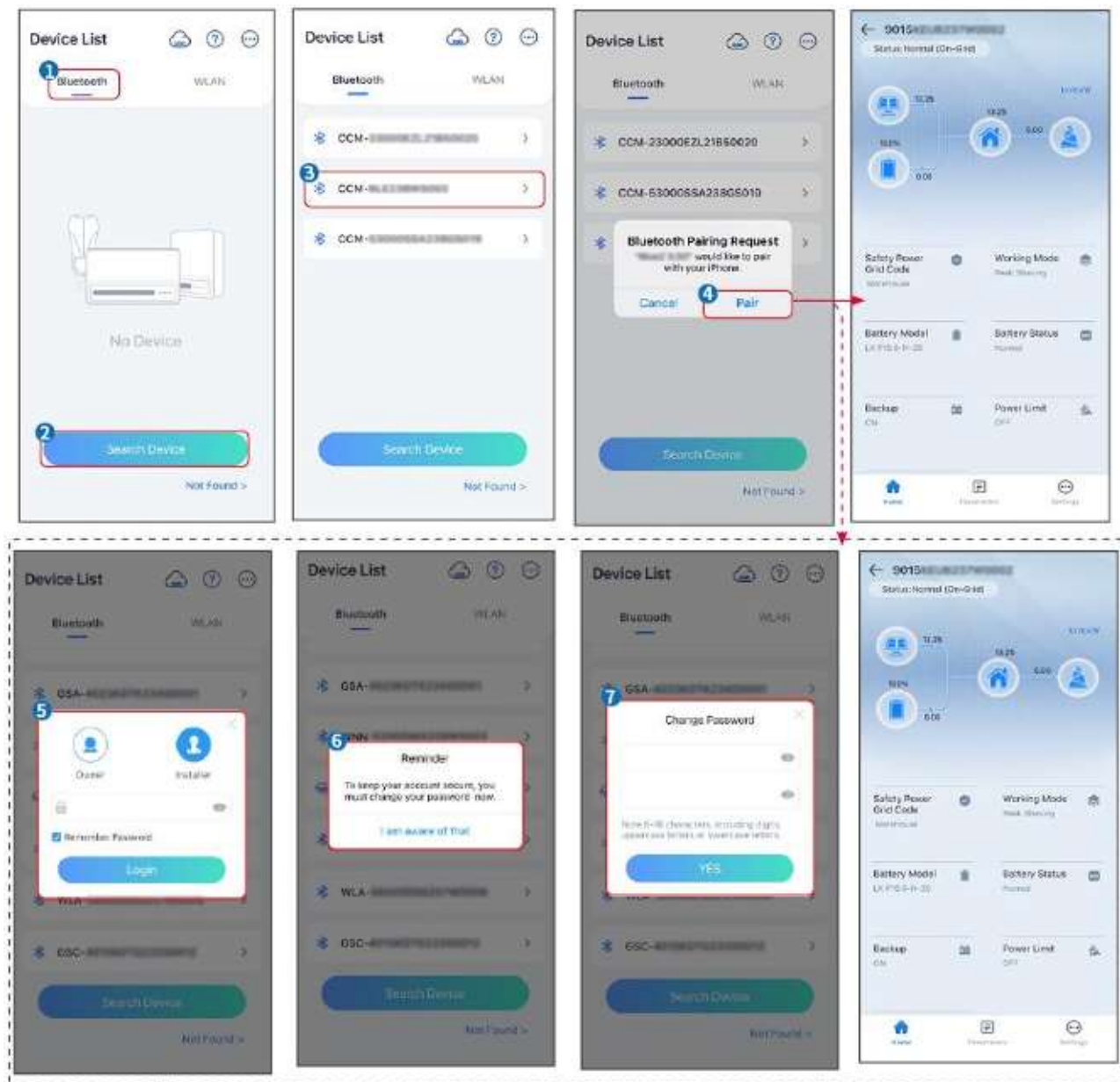

8.3 Communication Settings

NOTICE

The communication configuration interface may vary depending on the type of smart dongle connected to the inverter. Please refer to the actual interface for accurate information.

- Step 1 Tap **Home> Settings > Communication Settings > WLAN/LAN** to set the parameters.
 Step 2 Set the WLAN or LAN parameters based on actual situation.

No.	Name/Icon	Description
1	Network Name	Only for WLAN. Please select the corresponding network according to the actual situation and communicate the device with the router or switch.
2	Password	Only for WLAN. WiFi password for the actual connected network.

3	DHCP	<ul style="list-style-type: none"> ● Enable DHCP when the router is in dynamic IP mode. ● Disable DHCP when a switch is used or the router is in static IP mode.
4	IP Address	<ul style="list-style-type: none"> ● Do not configure the parameters when DHCP is enabled. ● Configure the parameters according to the router or switch information when DHCP is disabled.
5	Subnet Mask	
6	Gateway Address	
7	DNS Server	

8.4 Quick Settings

NOTICE

- The parameters will be configured automatically after selecting the safety country/region, including overvoltage protection, undervoltage protection, overfrequency protection, underfrequency protection, voltage/frequency connection protection, $\cos\phi$ curve, Q(U) curve, P(U) curve, FP curve, HVRT, LVRT, etc.
- The power generation efficiency of the inverter varies in different working modes. Please set according to the local actual power usage.

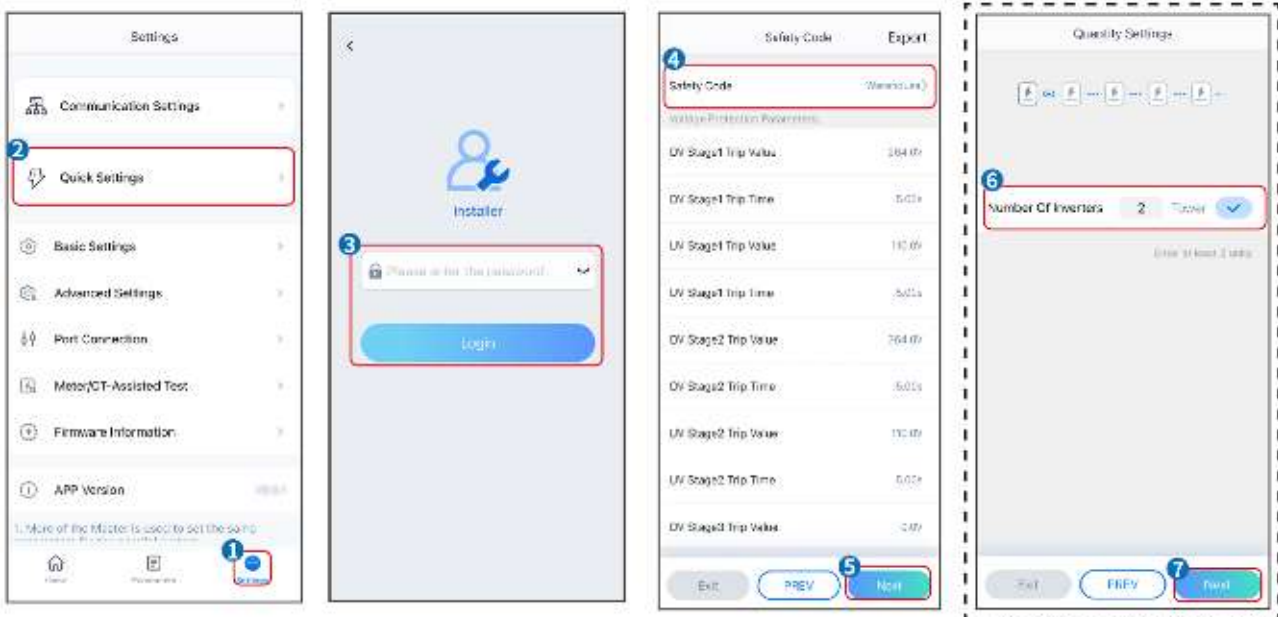

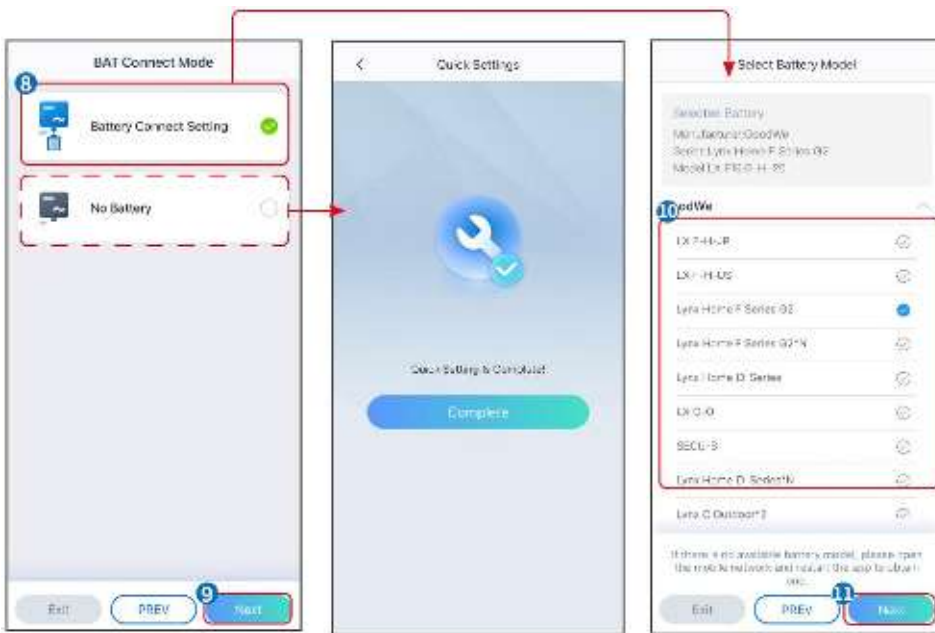

Parameters	Description
Safety Code	Select safety country accordingly.
Quantity Settings	In parallel scenarios, set the number of inverters in the parallel system based on actual situation.
BAT Connect Mode	Select the actual mode in which the battery is connected to the inverter. No need to set the battery model and working mode if there is no battery is connected. The system will work in self-use mode by default.
Select Battery Model	Select the actual battery model.
Working Mode	Set the working mode based on actual needs. Supports: Peakshaving mode and Self-use mode.

The app interface is as following when Self-use mode is selected. Enter Advanced Settings to set the detailed working mode and related parameters.

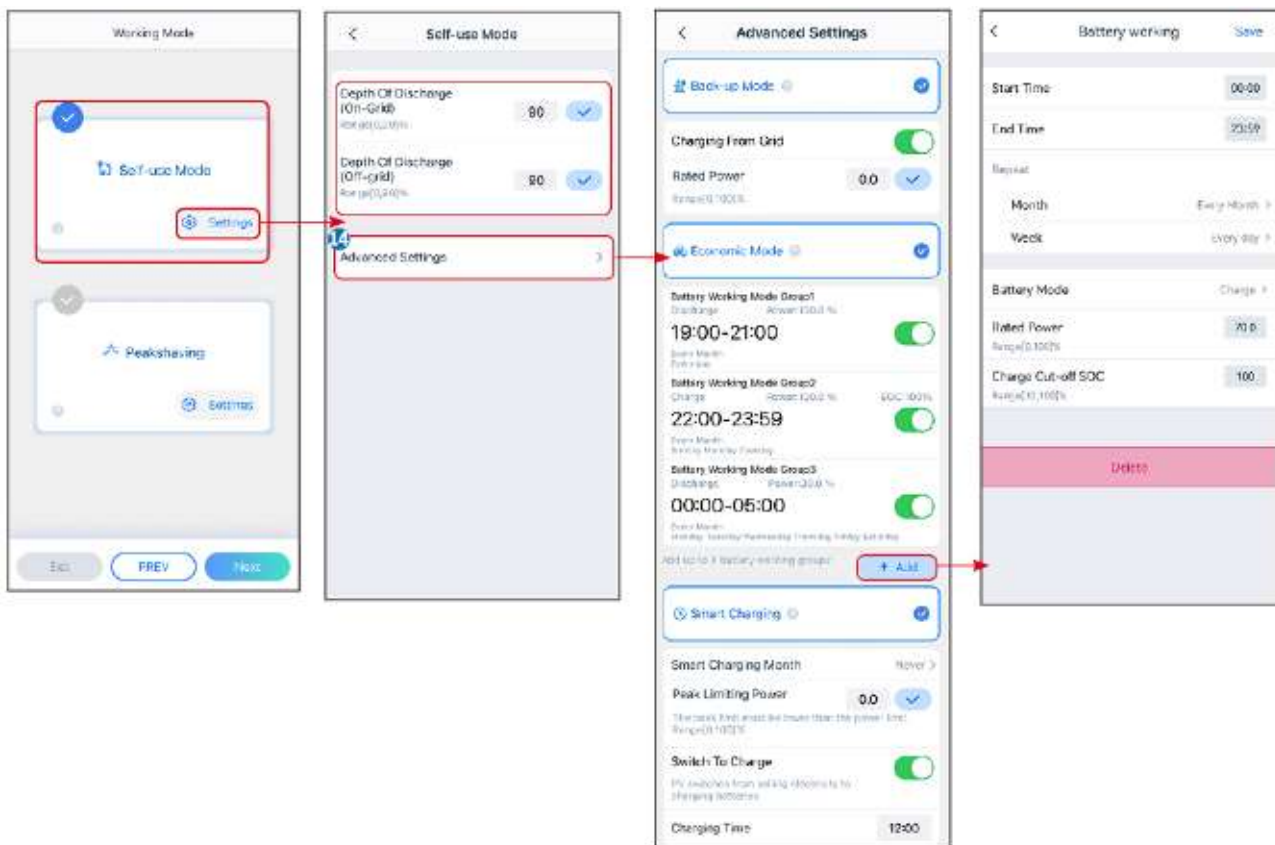

Parameters	Description
Self-use mode: based on the self-use mode, Back-up mode, Economic mode, and Smart charging can be enabled at the same time, and the inverter will automatically select the working mode. Working priority: Back-up mode> Economic mode >Smart charging	
Depth Of Discharge (On-Grid)	The maximum depth of discharge of the battery when the system is working on-grid.
Depth Of Discharge (Off-grid)	The maximum depth of discharge of the battery when the system is working off-grid.
Back-up mode	
Charging From Grid	Enable Charging From Grid to allow power purchasing from the utility grid.
Rated Power	The percentage of the purchasing power to the rated power of the inverter.
Economic mode	
Start Time	Within the Start Time and End Time, the battery is charged or discharged according to the set Battery Mode as well as the Rated Power.
End Time	
Battery Mode	Set the Battery Mode to Charging or Discharging accordingly.
Rated Power	The percentage of the charging/discharging power to the rated power of the inverter.
Charge Cut-off SOC	The battery stop charging/discharging once the battery SOC reaches Charge Cut-off SOC.
Smart charging	

Smart Charging Month	Set the smart charging months. More than one month can be set.
Peak Limiting Power	Set the Peak Limiting Power in compliance with local laws and regulations. The Peak Limiting Power shall be lower than the output power limit specified by local requirements.
Switch to Charge	During charging time, the PV power will charge the battery.

The app interface is as following when Peakshaving mode is selected.

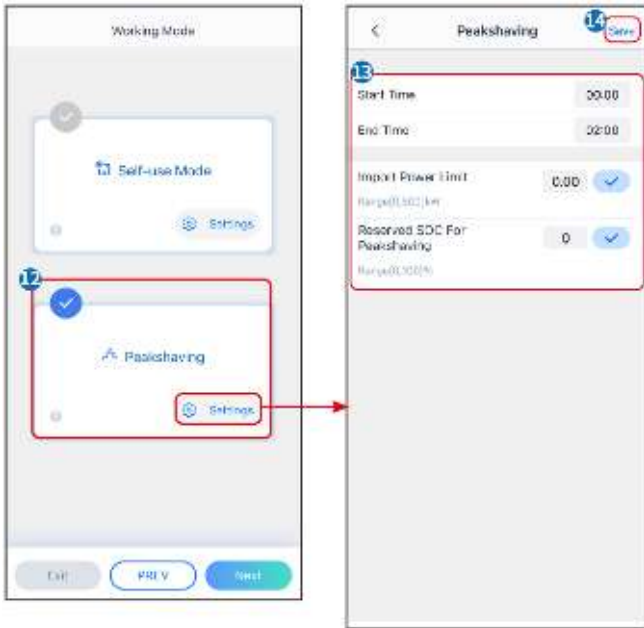

Parameters	Description
Peakshaving	
Start Time	The utility grid will charge the battery between Start Time and End Time if the load power consumption do not exceed the power quota. Otherwise, only PV power can be used to charge the battery.
End Time	
Import Power Limit	Set the maximum power limit allowed to purchase from the grid. When the loads consume power exceed the sum of the power generated in the PV system and Import Power Limit , the excess power will be made up by the battery.
Reserved SOC For Peakshaving	In Peak Shaving mode, the battery SOC should be lower than Reserved SOC For Peakshaving. Once the battery SOC is higher than Reserved SOC For Peakshaving, the peak shaving mode fails.

Tap **Complete** to complete the settings, restart the equipment following the prompts.

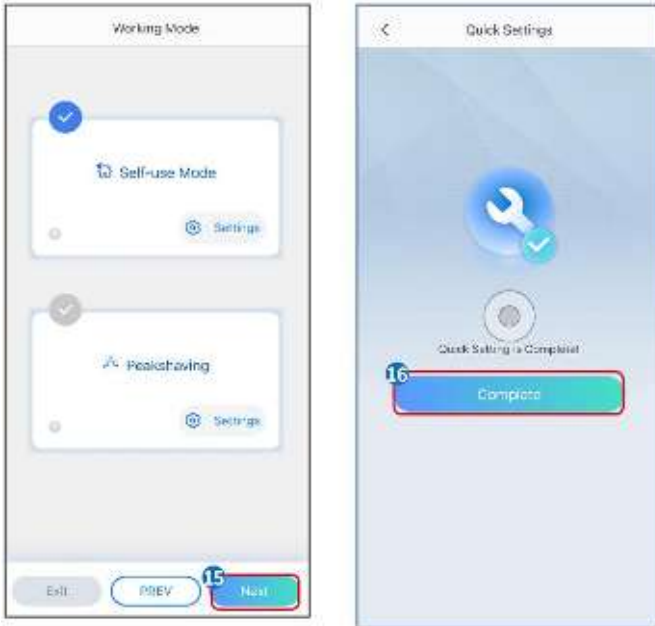

8.5 Creating Power Plants

NOTICE

Login to the SEMS Portal app using the account and password before creating power plants. If you have any questions, refer to the Plant Monitoring section.

Step 1 Enter the **Create Plant** page.

Step 2 Read the instructions and fill in the requested plant information based on actual situation. (* refers to the mandatory items)

Step 3 Follow the prompts to add devices and create the plant.

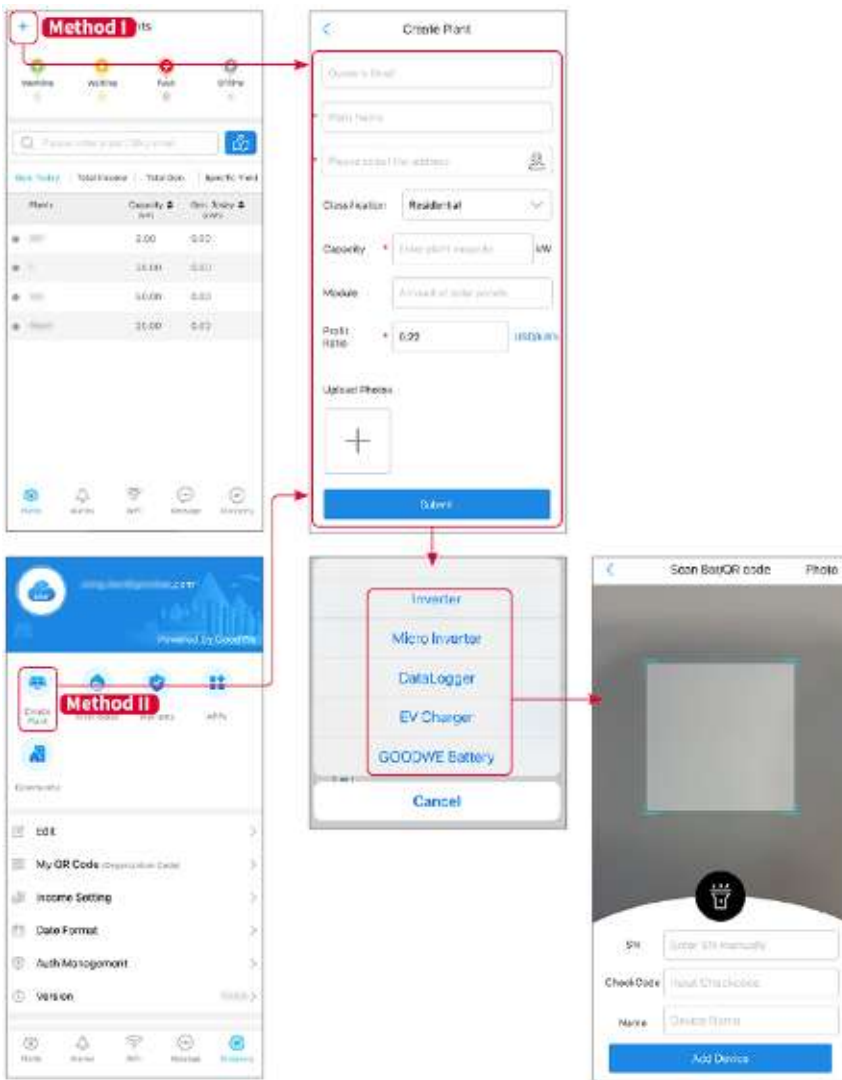

9 System Commissioning

9.1 SolarGo Overview

SolarGo App is a mobile application that communicates with the inverter through bluetooth or WiFi modules. Commonly used functions are as follows:

1. Check the operating data, software version, alarms, etc.
2. Set grid parameters, communication parameters, safety countries, power limitation, etc.
3. Equipment maintenance.
4. Upgrade the firmware version of the equipment.

9.1.1 Menu Structure of the App

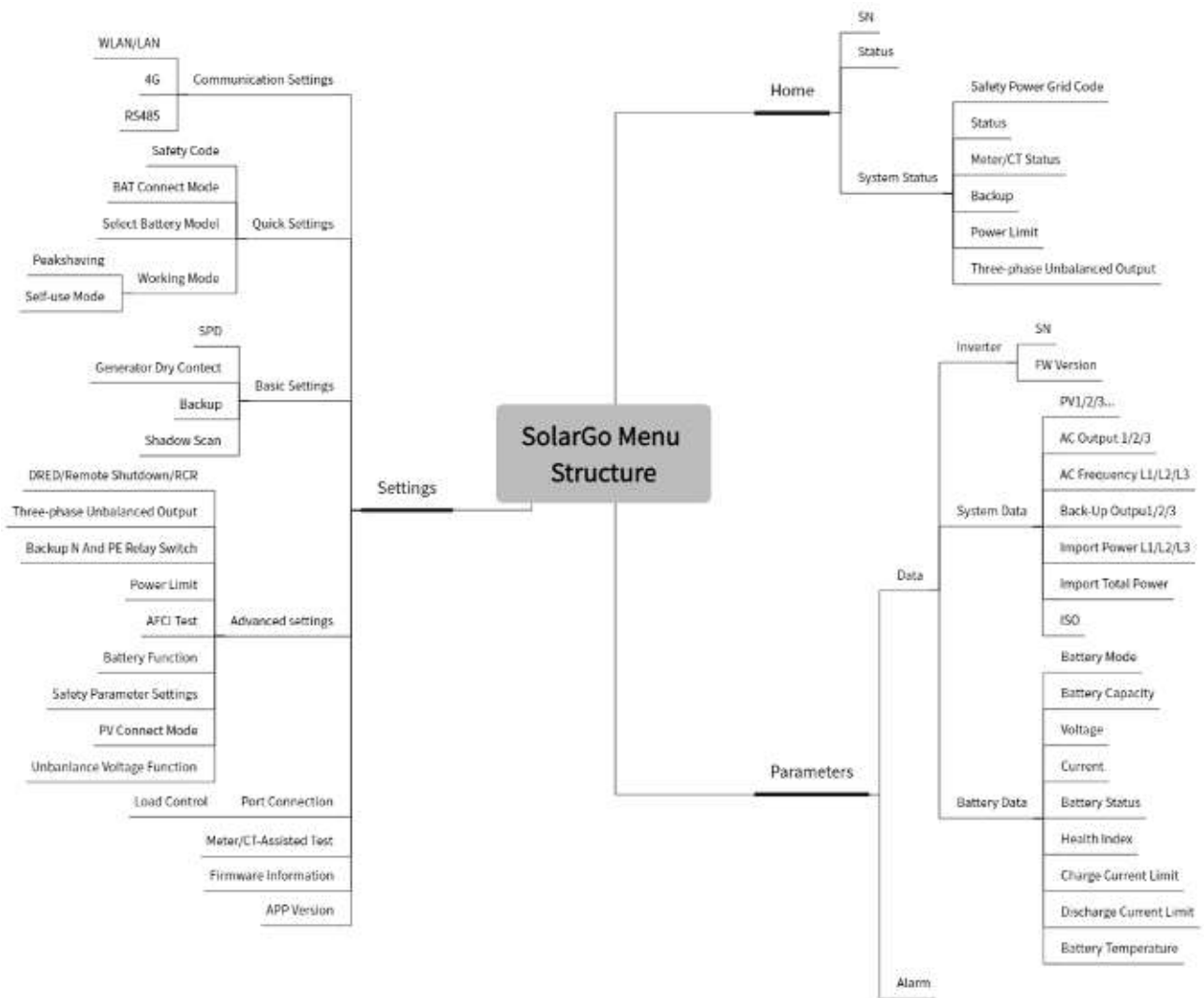

9.1.2 Login Page of SolarGo App

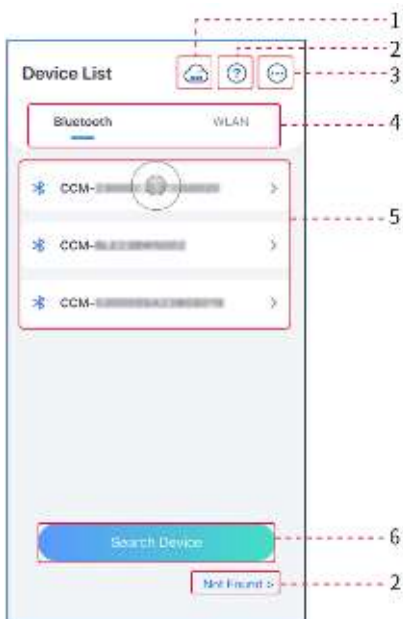

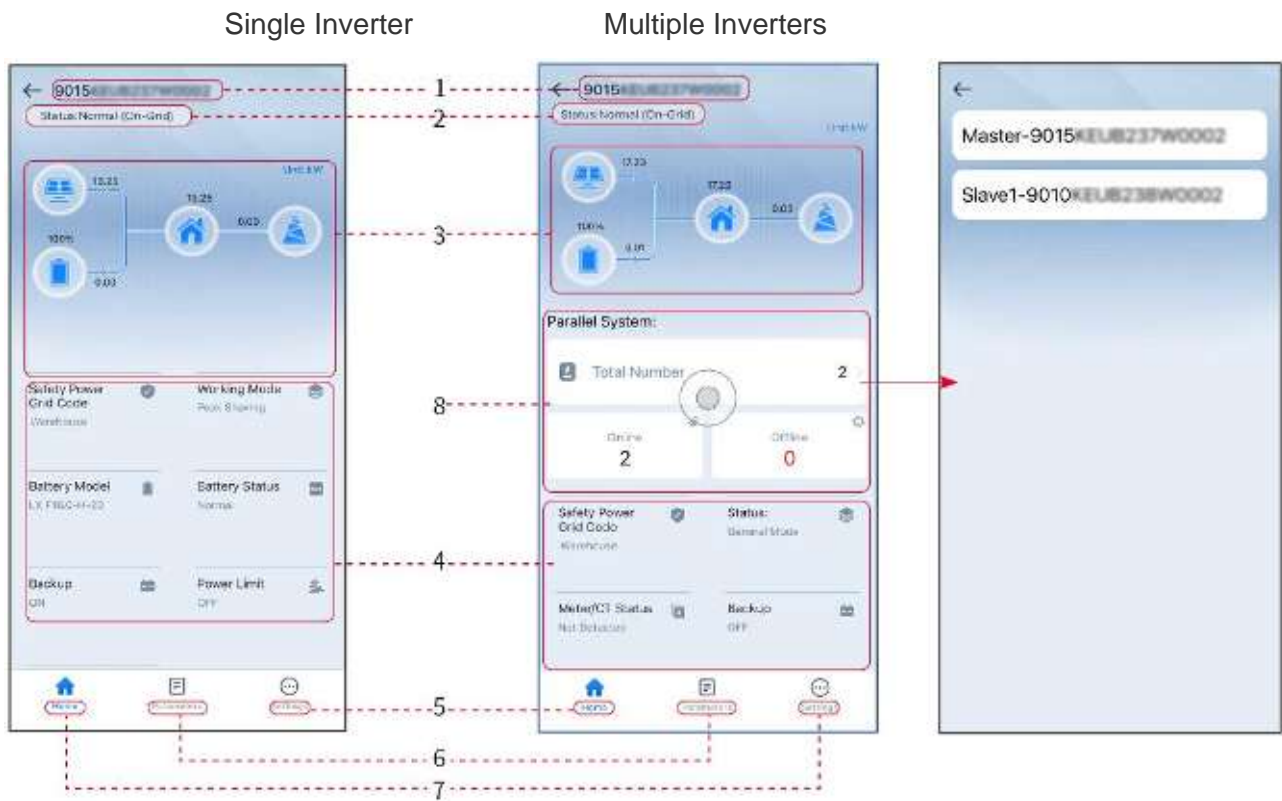

No.	Name / Icon	Description
1		Tap the icon to open the page downloading the SEMS Portal app.
2		Tap to read the connection guide.
	Not found	
3		<ul style="list-style-type: none"> ● Check information such as app version, local contacts, etc. ● Other settings, such as update date, switch language, set temperature unit, etc.
4	Bluetooth/WLAN	Select based on actual communication method. If you have any problems, tap or NOT Found to read the connection guides.
5	Device List	<ul style="list-style-type: none"> ● The list of all devices. The last digits of the device name are normally the serial number of the device. ● Select the device by checking the serial number of the master inverter when multi inverters are parallel connected. ● The device name varies depending on the inverter model or communication module.
6	Search Device	Tap Search Device if the device is not found.

9.1.3 Home Page of SolarGo App



No.	Name/Icon	Description
-----	-----------	-------------

1	Serial Number	Serial number of the connected inverter or serial number of the master inverter in the parallel system.
2	Device Status	Indicates the status of the inverter, such as Working, Fault, etc.
3	Energy Flow Chart	Indicates the energy flow chart of the PV system. The actual page prevails.
4	System Status	Indicates the system status, such as Safety Code, Working Mode, Battery Model, Battery Status, Power Limit, Three-Phase Unbalanced Output, etc.
5	 Home	Home. Tap Home to check Serial Number, Device Status, Energy Flow Chart, System Status, etc.
6	 Parameters	Parameters. Tap Parameters to check the running parameters of the system.
7	 Settings	Settings. Log in before entering Quick Settings and Advanced Settings. Initial password: goodwe2010 or 1111.
8	Parallel	Tap Total Number to check serial number of all inverters. Tap the serial number to enter the setting page of the single inverter.

9.2 Connecting the Inverter

NOTICE

The device name varies depending on the inverter model or communication module:

- Wi-Fi Kit: Solar-WiFi***
- Bluetooth module: Solar-BLE***
- WiFi/LAN Kit-20: WLA-***
- Ezlink3000: CCM-BLE***; CCM-***; ***
- 4G Kit-CN-G20 or 4G Kit-CN-G21: GSA-*** or GSB-***

*** is the inverter serial number*

Connecting the inverter via bluetooth

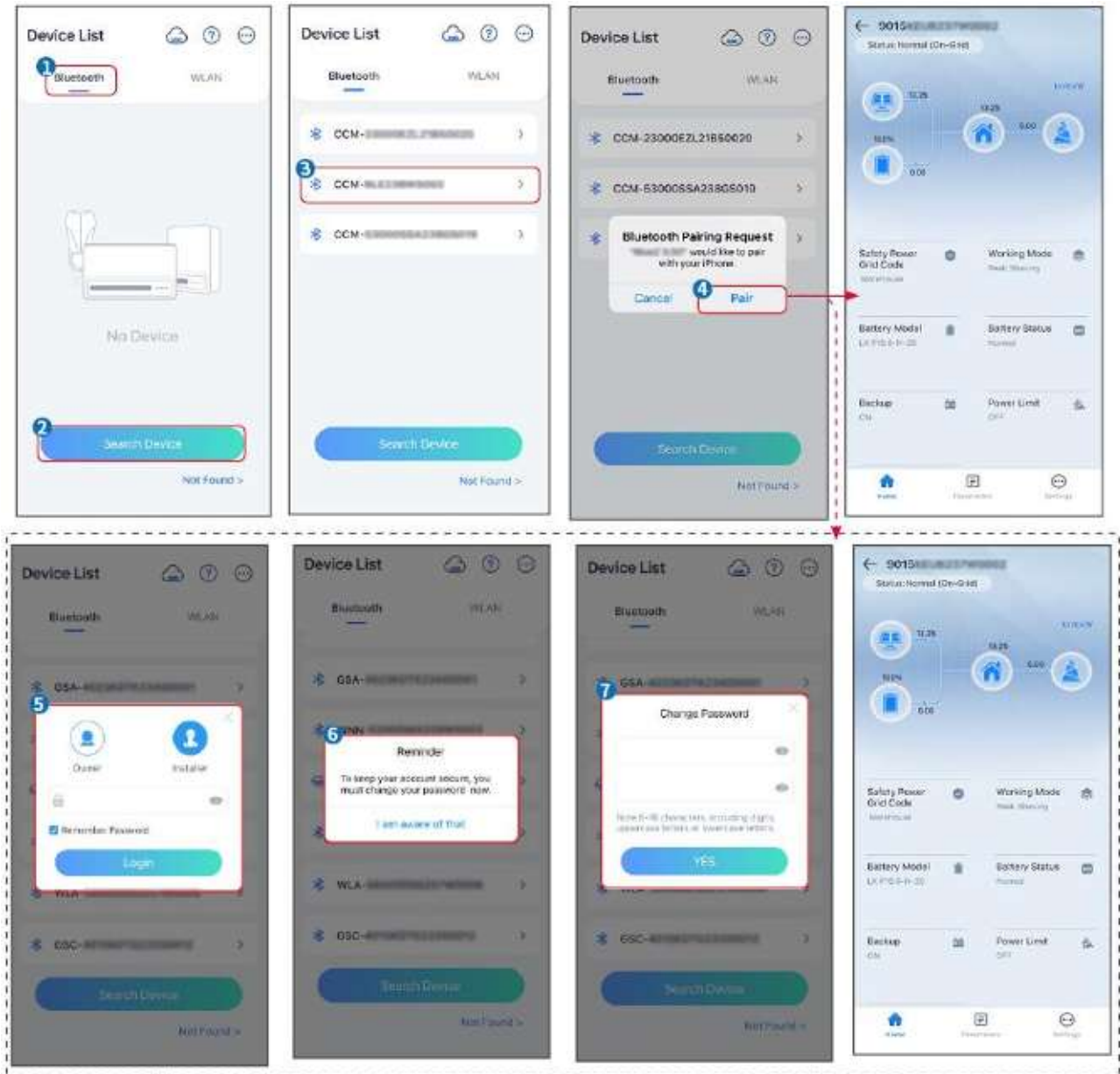

9.3 Communication Settings

NOTICE

The communication configuration interface may vary depending on the type of smart dongle connected to the inverter. Please refer to the actual interface for accurate information.

Setting Privacy and Security

Type I

Step 1 Tap **Home > Settings > Communication Setting > Privacy & Security** to set the parameters.

Step 2 Set the new password for the WiFi hotspot of the communication module, and tap **Save**.

Step 3 Open the WiFi settings of your phone and connect to the inverter's WiFi signal (SolarWiFi***) with the new password.

Type II

Step 1 Tap **Home > Settings > Communication Setting > Privacy & Security** to set the parameters.

Step 2 Enable Bluetooth Stays On or WLAN Control based on actual needs.

Setting WLAN/ LAN Parameters

Step 1 Tap **Home > Settings > Communication Settings > Network Settings** to set the parameters.

Step 2 Set the WLAN or LAN parameters based on actual situation.

No.	Name/Icon	Description
1	Network Name	Only for WLAN. Please select the corresponding network according to the actual situation and communicate the device with the router or switch.
2	Password	Only for WLAN. WiFi password for the actual connected network.
3	DHCP	<ul style="list-style-type: none">● Enable DHCP when the router is in dynamic IP mode.● Disable DHCP when a switch is used or the router is in static IP mode.
4	IP Address	<ul style="list-style-type: none">● Do not configure the parameters when DHCP is enabled.● Configure the parameters according to the router or switch information when DHCP is disabled.
5	Subnet Mask	
6	Gateway Address	
7	DNS Server	

9.4 Quick Settings

NOTICE

- The parameters will be configured automatically after selecting the safety country/region, including overvoltage protection, undervoltage protection, overfrequency protection, underfrequency protection, voltage/frequency connection protection, $\cos\phi$ curve, Q(U) curve, P(U) curve, FP curve, HVRT, LVRT, etc.
- The power generation efficiency of the inverter varies in different working modes. Please set according to the local actual power usage.

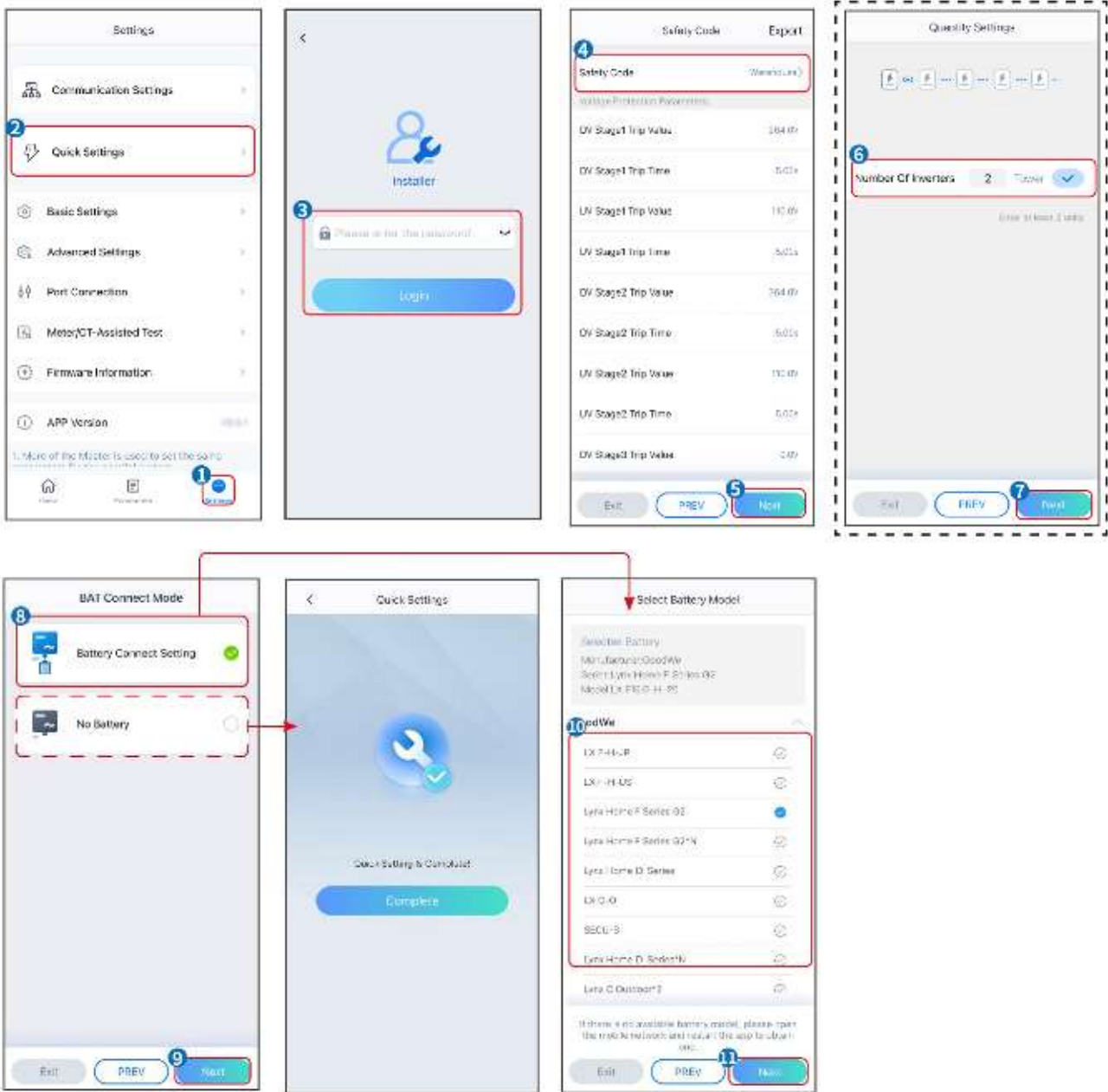

Parameters	Description
Safety Code	Select safety country accordingly.
BAT Connect Mode	Select the actual mode in which the battery is connected to the inverter. No need to set the battery model and working mode if there is no battery is connected. The system will work in self-use mode by default.
Quantity Settings	In parallel scenarios, set the number of inverters in the parallel system based on actual situation.
Select Battery Model	Select the actual battery model.
Working Mode	Set the working mode based on actual needs. Supports: Peakshaving mode and Self-use mode.

The app interface is as following when Self-use mode is selected. Enter Advanced Settings to set the detailed working mode and related parameters.

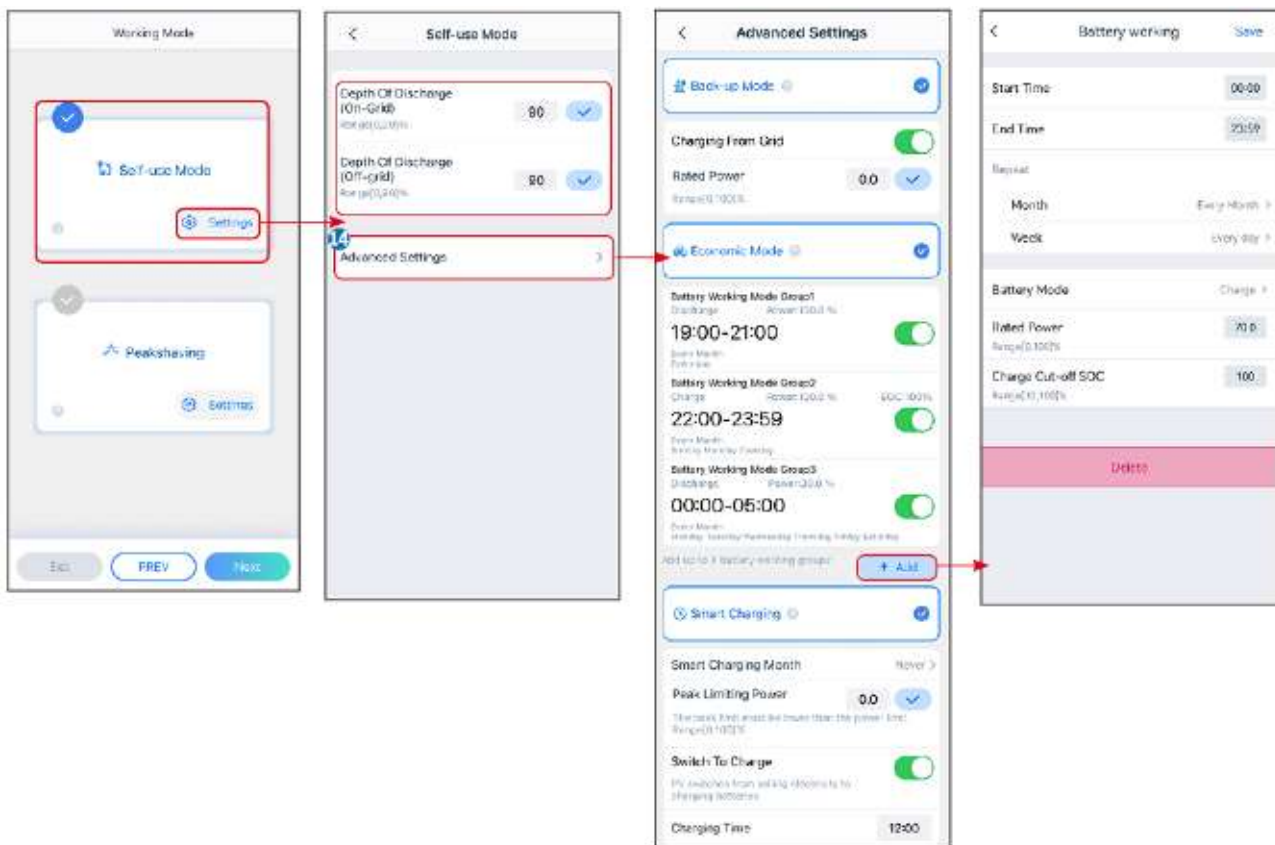

Parameters	Description
Self-use mode: based on the self-use mode, Back-up mode, Economic mode, and Smart charging can be enabled at the same time, and the inverter will automatically select the working mode. Working priority: Back-up mode> Economic mode >Smart charging	
Depth Of Discharge (On-Grid)	The maximum depth of discharge of the battery when the system is working on-grid.
Depth Of Discharge (Off-grid)	The maximum depth of discharge of the battery when the system is working off-grid.
Back-up mode	
Charging From Grid	Enable Charging From Grid to allow power purchasing from the utility grid.
Rated Power	The percentage of the purchasing power to the rated power of the inverter.
Economic mode	
Start Time	Within the Start Time and End Time, the battery is charged or discharged according to the set Battery Mode as well as the Rated Power.
End Time	
Battery Mode	Set the Battery Mode to Charging or Discharging accordingly.
Rated Power	The percentage of the charging/discharging power to the rated power of the inverter.
Charge Cut-off SOC	The battery stop charging/discharging once the battery SOC reaches Charge Cut-off SOC.
Smart charging	

Smart Charging Month	Set the smart charging months. More than one month can be set.
Peak Limiting Power	Set the Peak Limiting Power in compliance with local laws and regulations. The Peak Limiting Power shall be lower than the output power limit specified by local requirements.
Switch to Charge	During charging time, the PV power will charge the battery.

The app interface is as following when Peakshaving mode is selected.

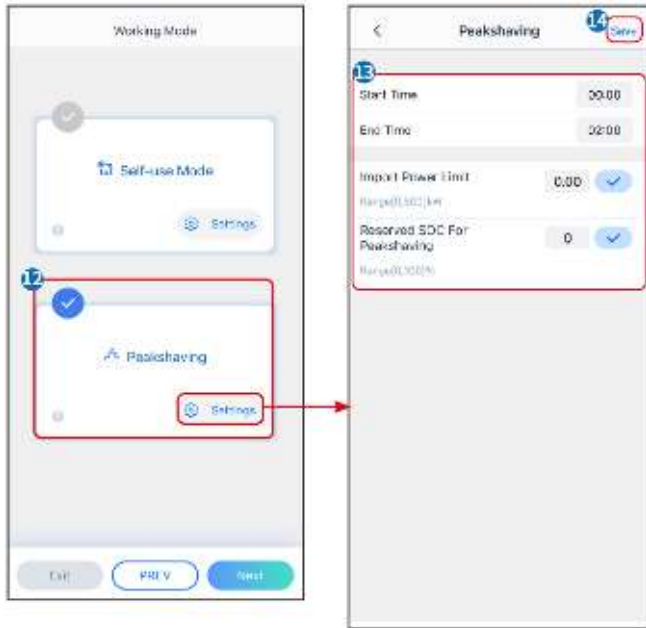

Parameters	Description
Peakshaving	
Start Time	The utility grid will charge the battery between Start Time and End Time if the load power consumption do not exceed the power quota. Otherwise, only PV power can be used to charge the battery.
End Time	
Import Power Limit	Set the maximum power limit allowed to purchase from the grid. When the loads consume power exceed the sum of the power generated in the PV system and Import Power Limit , the excess power will be made up by the battery.
Reserved SOC For Peakshaving	In Peak Shaving mode, the battery SOC should be lower than Reserved SOC For Peakshaving. Once the battery SOC is higher than Reserved SOC For Peakshaving, the peak shaving mode fails.

Tap **Complete** to complete the settings, restart the equipment following the prompts.

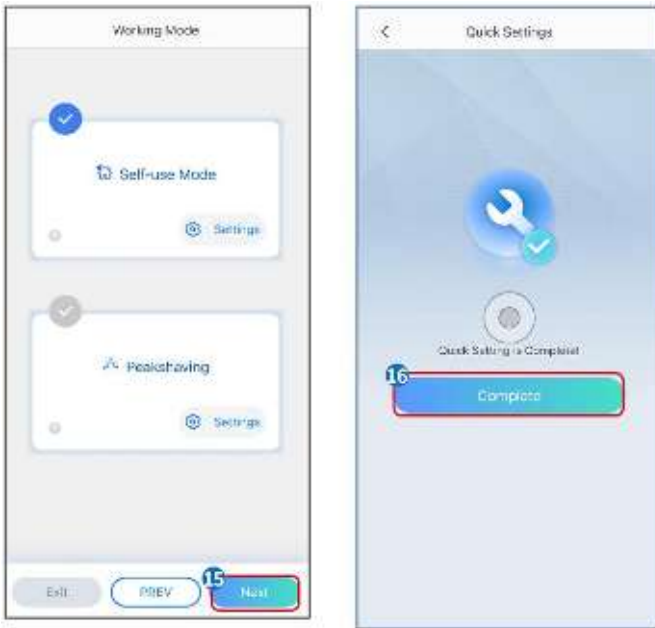

9.5 Setting the Basic Information

9.5.1 Setting Shadow Scan and SPD

Step 1 Tap **Home > Settings > Basic Settings** to set the parameters.

Step 2 Set the functions based on actual needs.

Shadow Scan and SPD

No.	Parameters	Description
1	Shadow Scan	Enable Shadow Scan when the PV panels are severely shadowed to optimize the power generation efficiency.
2	SPD	After enabling SPD , when the SPD module is abnormal, there will be SPD module abnormal alarm prompt.

9.5.2 Setting the Backup Function

After enabling Backup, the battery will power the load connected to the backup port of the inverter to ensure Uninterrupted Power Supply when the power grid fails.

No.	Parameters	Description
1	UPS Mode - Full Wave Detection	Check whether the utility grid voltage is too high or too low.
2	UPS Mode - Half Wave Detection	Check whether the utility grid voltage is too low.
3	EPS Mode - Supports LVRT	Stop detecting utility grid voltage.

4	First Cold Start (Off grid)	Take effect once. In off-grid mode, enable First Cold Start (Off-grid) to output backup supply with battery or PV.
5	Cold Start Holding	Take effect multiple times. In off-grid mode, enable First Cold Start (Off-grid) to output backup supply with battery or PV.
6	Clear Overload History	Once the power of loads connected to the inverter BACK-UP ports exceeds the rated load power, the inverter will restart and detect the power again. The inverter will perform restart and detection several times until the overloading problem is solved. Tap Clear Overload History to reset the restart time interval after the power of the loads connected to the BACK-UP ports meets the requirements. The inverter will restart immediately

9.6 Setting Advanced Parameters

9.6.1 Setting AFCI

AFCI (Optional)

Reason to occur electric arcs

- Damaged connectors in PV or battery system.
- Wrong connected or broken cables.
- Aging of connectors and cables.

Methods to detect electric arcs:

- The inverter has an integrated AFCI function satisfies IEC63027.
- When the inverter detects an electric arc, users can find the time of the fault and the detailed phenomenon through SolarGo App.
- The inverter will shutdown for protection until the AFCI alarms are cleared. After clearing the alarms, the inverter can automatically reconnect to the grid.
 - Automatic reconnection: The alarm can be cleared automatically in 5 minutes if the inverter triggers a fault for less than 5 times within 24 hours.
 - Manual reconnection: The inverter will shutdown for protection after the 5th electric arc fault within 24 hours. The inverter cannot work normally until the fault is solved.

AFCI is disabled by default, enable it through SolarGo app if needed.

Model	Label	Description
GW6000-ET-20	F-I-AFPE-1-2-1	F: Full coverage I: Integrated AFPE: Detection and interruption capability provided 1: 1 monitored string per input port 2: 2 input ports per channel 1: 1 monitored channel
GW8000-ET-20		
GW9900-ET-20	F-I-AFPE-1-2/1-2	F: Full coverage I: Integrated AFPE: Detection and interruption capability provided 1: 1 monitored string per input port 2/1: 2/1 input ports per channel(AFD1: 2 , AFD2: 1)
GW10K-ET-20		
GW12K-ET-20		

GW15K-ET-20	2: 2 monitored channels
-------------	-------------------------

Step 1 Tap **Home > Settings > Advanced Settings > AFCI** to set the parameters.

Step 2 Set the parameters based on actual needs. Tap \checkmark or Save to save the settings. The parameters are set successfully.

Parameters	Description
AFCI Test	Enable or disable AFCI accordingly.
AFCI Test Status	The test status, like Not Self-checking, self-check succeeded, etc.
Clear AFCI Alarm	Clear ARC Faulty alarm records.
Self-check	Tap to check whether the AFCI function works normally.

9.6. 2 Setting PV Connect Mode

Step 1 Tap **Home > Settings > Advanced Settings > PV Connect Mode** to set the parameters.

Step 2 Select the actual mode in which the PV is connected to the inverter, and tap \checkmark .

Parameters	Description
Stand-alone Connect	The PV strings are connected to the MPPT terminals one by one.
Partial Parallel Connect	The PV strings are connected to the inverter in both stand-alone and parallel connection. For example, one PV string connect to MPPT1 and MPPT2, another PV string connect to MPPT3.
Parallel Connect	The external PV string is connected to multi MPPT terminals of the inverter.

9.6.3 Setting Power Limit Parameters

Step 1 Tap **Home > Settings > Advanced Settings > Power Limit** to set the parameters.

Step 2 Enable or disable the power limit function based on actual needs.

Step 3 Enter the parameters and tap \checkmark . The parameters are set successfully.

No.	Parameters	Description
1	Power Limit	Enable Power Limit when power limiting is required by local grid standards and requirements.
2	Export Power (W)	Set the value based on the actual maximum power feed into the utility grid.
3	External CT Ratio	Set the ratio of the primary current to the secondary current of the external CT.

9.6.4 Setting the Battery Parameters

Step 1 Tap **Home > Settings > > Battery Function** to set the parameters.

Step 2 Enter the parameters and tap \checkmark . The parameters are set successfully.

No.	Parameters	Description
-----	------------	-------------

1	SOC Protection	Start battery protection when the battery capacity is lower than the Depth of Discharge.
2	Depth Of Discharge (On-Grid)	Indicates the depth of discharge of the battery when the inverter is on-grid or off-grid.
3	Depth Of Discharge (Off-grid)	
4	Backup SOC Holding	The battery will be charged to preset SOC protection value by utility grid or PV when the system is running on-grid. So that the battery SOC is sufficient to maintain normal working when the system is off-grid.
5	Immediate Charging	Enable to charge the battery by the grid immediately. It will only take effect once. Enable or Disable based on actual needs.
6	SOC For Stopping Charging	Stop charging the battery once the battery SOC reaches SOC For Stopping Charging.
7	Immediate Charging Power	Indicates the percentage of the charging power to the inverter rated power when enabling Immediate Charging . For example, setting the Immediate Charging Power of a 10kW inverter to 60 means the charging power of the inverter is $10\text{kW} \times 60\% = 6\text{kW}$. <ul style="list-style-type: none"> ● Start: tap to start charging. ● Stop: tap to stop charging.

9.7 Setting Load Control

Step 1 Tap **Home > Settings > Load Control** to set the parameters.

Step 2 Enter the parameters and tap \checkmark . The parameters are set successfully.

Dry Contact Mode: when the switch is ON, the loads will be powered; when the switch is OFF, the power will be cut off. Turn the switch on or off based on actual needs.

Time Mode: set the time to enable the load, and the load will be powered automatically within the setting time period. Select standard mode or intelligent mode.

No.	Parameters	Description
1	Standard	The loads will be powered within the setting time period.
2	Intelligent	Once the excess energy of the photovoltaic exceeds the load nominal power within the time period, the loads will be powered.
3	Start Time	The time mode will be on between the Start Time and End Time.
4	End Time	
5	Repeat	The repeat days.
6	Load Consumption Time	The shortest load working time after the loads been powered. The time is set to prevent the loads be turned on and off frequently when the PV

		power fluctuates greatly. Only for Intelligent mode.
7	Load Rated Power	The loads will be powered when the excess energy of the photovoltaic exceeds the nominal power of load. Only for Intelligent mode.

SOC mode: the inverter has an integrated relay controlling port, which can control the loads off or on. In off-grid mode, the load connected to the port will not be powered if the BACKUP overload is detected or the battery SOC value is lower than the Off-grid battery protection value.

9.8 Setting Safety Parameters

9.8.1 Setting Basic Safety Parameters

NOTICE

The grid standards of some countries/regions require that inverters shall set functions to meet local requirements.

Step 1 Tap **Home > Settings > Advanced Settings** to set the parameters.

No.	Parameters	Description
1	DRED/Remote Shutdown/RCR/EnWG 14a	Enable DRED/Remote Shutdown/RCR/EnWG 14a before connecting the third party DRED, remote shutdown, or RCR, EnWG 14a device to comply with local laws and regulations.
2	Three-phase Unbalanced Output	Enable Three-phase Unbalanced Output when the utility grid company adopts phase separate billing.
3	Backup N and PE Relay Switch	To comply with local laws and regulations, ensure that the relay inside the back-up port remains closed and the N and PE wires are connected when the inverter is working off-grid.
4	AutoTest	Enable AUTO TEST to set auto test for grid tying in compliance with local grid standards and requirements.

9.8.2 Setting Customized Safety Parameters

NOTICE

Set the custom safety parameters in compliance with local requirements. Do not change the parameters without the prior consent of the grid company.

9.8.2.1 Setting the Active Power Mode

Setting the P(F) Curve

Step 1 Tap **Home > Settings > Advanced Settings > Safety Parameter Settings > Active Power Mode** to set the parameters.

Step 2 Set the parameters based on actual needs.

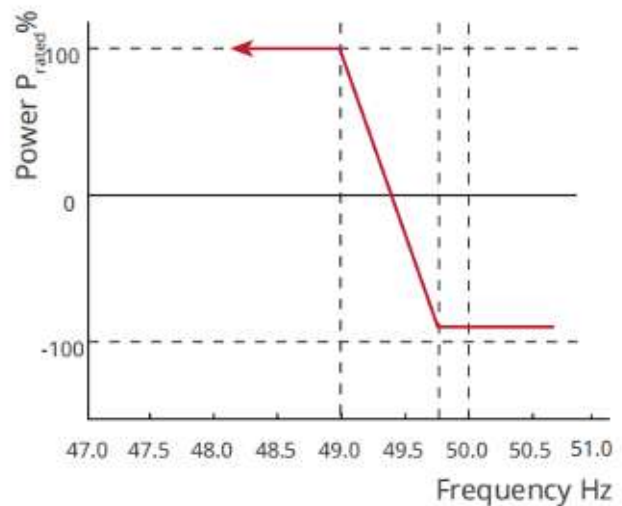
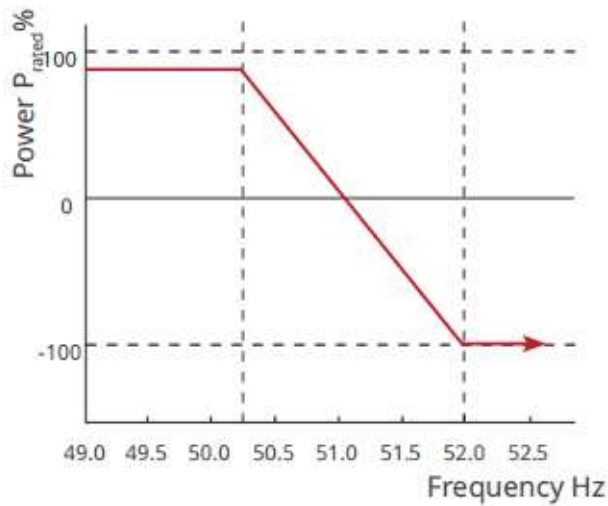

Setting the P(U) Curve

Step 1 Tap **Home** > **Settings** > **Advanced Settings** > **Safety Parameter Settings** > **Active Power Mode** to set the parameters.

Step 2 Enter the parameters. The inverter will adjust the active output power to the apparent power ratio in real-time according to the actual grid voltage to the rated voltage ratio.

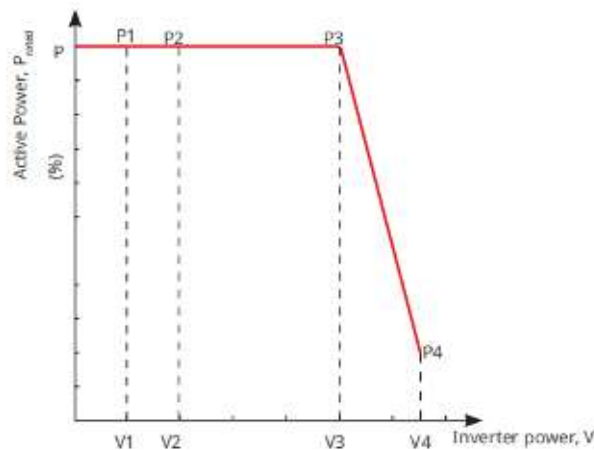

9.8.2.2 Setting the Reactive Power Mode

Setting the Fix PF

Step 1 Tap **Home** > **Settings** > **Advanced Settings** > **Safety Parameter Settings** > **Reactive Power Mode** to set the parameters.

Step 2 Set the parameter based on actual needs. The power factor remains fixed during the inverter working process.

No.	Parameters	Description
1	Fix PF	Enable Fix PF when it is required by local grid standards and requirements.
2	Under-excited	Set the power factor as lagging or leading based on actual needs and local grid standards and requirements.
3	Over-excited	
4	Power Factor	Set the power factor based on actual needs. Range: 0~-0.8, or +0.8~+1.

Setting the Fix Q

Step 1 Tap **Home** > **Settings** > **Advanced Settings** > **Safety Parameter Settings** >

Reactive Power Mode to set the parameters.

Step 2 Set the parameter based on actual needs. The output reactive power remains fixed during the inverter working process.

No.	Parameters	Description
1	Fix Q	Enable Fix Q when it is required by local grid standards and requirements.
2	Under-excited	Set the reactive power as inductive or capacitive reactive power based on actual needs and local grid standards and requirements.
3	Over-excited	
4	Power Factor	The percentage of reactive output power to apparent power.

Setting the Q(U) Curve

Step 1 Tap **Home** > **Settings** > **Advanced Settings** > **Safety Parameter Settings** > **Reactive Power Mode** to set the parameters.

Step 2 Enter the parameters. The inverter will adjust the reactive power to the apparent power ratio in real-time according to the actual grid voltage to the rated voltage ratio.

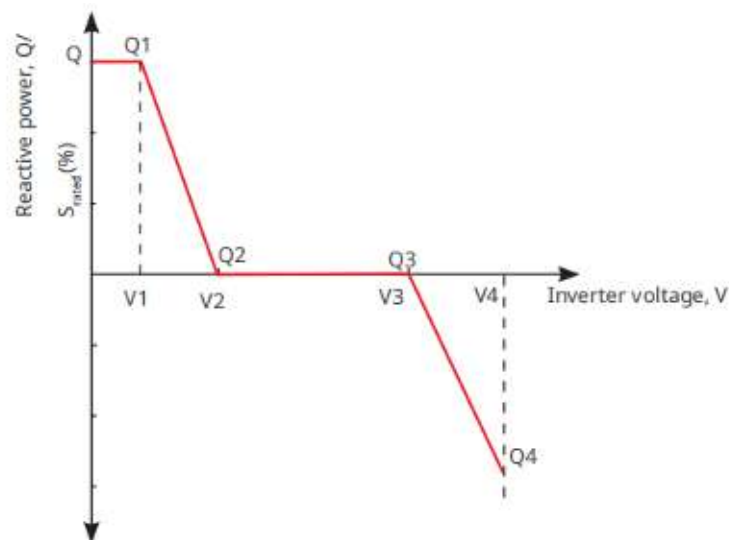

Setting the Cosφ Curve

Step 1 Tap **Home** > **Settings** > **Advanced Settings** > **Safety Parameter Settings** > **Reactive Power Mode** to set the parameters.

Step 2 Enter the parameters. The inverter will adjust the active output power to the apparent power ratio in real-time according to the actual grid voltage to the rated voltage ratio.

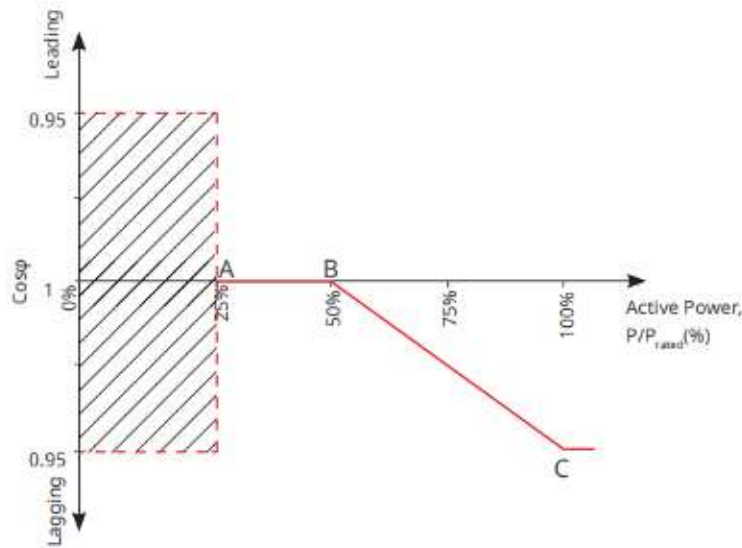

9.8.2.3 Setting Protection Parameters

Step 1 Tap **Home > Settings > Advanced Settings > Safety Parameter Settings > Protection Parameters** to set the parameters.

Step 2 Set the parameters based on actual needs.

No.	Parameters	Description
Voltage Protection Parameters		
1	OV Stage n Trip Value	Set the grid overvoltage protection threshold value, n = 1, 2, 3.
2	OV Stage n Trip Time	Set the grid overvoltage protection tripping time, n = 1, 2, 3.
3	UV Stage n Trip Value	Set the grid undervoltage protection threshold value, n= 1, 2, 3.
4	UV Stage n Trip Time	Set the grid undervoltage protection tripping time, n = 1, 2, 3.
5	Grid 10min Overvoltage	Set the 10min overvoltage protection threshold value.
Frequency Protection Parameters		
6	OF Stage n Trip Value	Set the grid overfrequency protection threshold value, n = 1, 2, 3.
7	OF Stage n Trip Time	Set the grid overfrequency protection tripping time, n = 1, 2.
8	UF Stage n Trip Value	Set the grid underfrequency protection threshold value, n = 1, 2.
9	UF Stage n Trip Time	Set the grid underfrequency protection tripping time, n = 1, 2.

9.8.2.4 Setting Connection Parameters

Step 1 Tap **Home > Settings > Advanced Settings > Safety Parameter Settings > Connection Parameters** to set the parameters.

Step 2 Set the parameters based on actual needs.

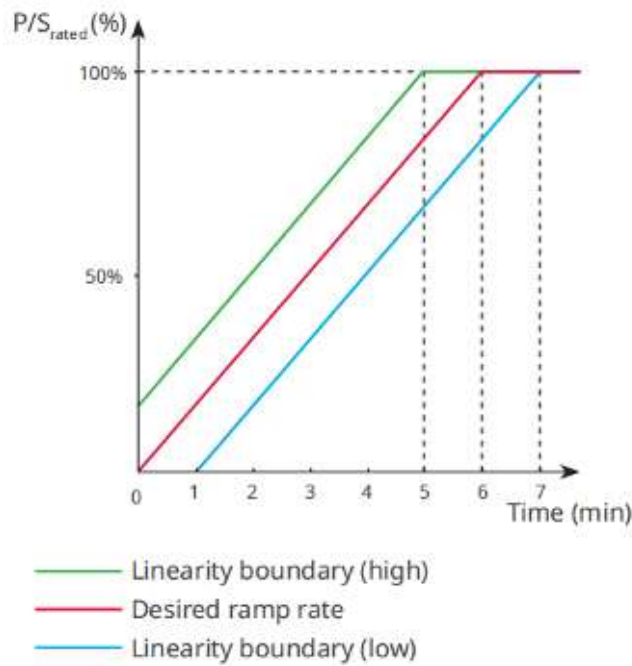

9.8.2.5 Setting Voltage Ride Through Parameters

Step 1 Tap **Home > Settings > Advanced Settings > Safety Parameter Settings > Voltage Ride Through** to set the parameters.

Step 2 Set the parameters based on actual needs.

No.	Parameters	Description
LVRT		
1	Ride Through Voltage Start Point	The inverter will not be disconnected from the utility grid immediately when the grid voltage is between Ride Through Voltage Start Point and Ride Through Voltage End Point.
2	Ride Through Voltage End Point	
3	Ride Through Time Start Point	Indicates the longest duration the inverter can remain undischarged from the grid when the grid voltage is at the Ride Through Voltage Start Point.
4	Ride Through Time End Point	Indicates the longest duration the inverter can remain undischarged from the grid when the grid voltage is at the Ride Through Voltage End Point.
5	Ride Through Trip Threshold	LVRT is allowed when the grid voltage is lower than Ride Through Trip Threshold
HVRT		
6	Ride Through Voltage Start Point	The inverter will not be disconnected from the utility grid immediately when the grid voltage is between Ride Through Voltage Start Point and Ride Through Voltage End Point.
7	Ride Through	

	Voltage End Point	
8	Ride Through Time Start Point	Indicates the longest duration the inverter can remain connected to the grid when the grid voltage is at the Ride Through Voltage Start Point.
9	Ride Through Time End Point	Indicates the longest duration the inverter can remain connected to the grid when the grid voltage is at the Ride Through Voltage End Point.
10	Ride Through Trip Threshold	HVRT is allowed when the grid voltage is higher than Ride Through Trip Threshold

10 Monitoring Power Plant

10.1 SEMS Portal Overview

SEMS Portal App is a monitoring platform. Commonly used functions are as follows:

1. Manage the organization or User information;
2. Add and monitor the power plant information;
3. Equipment maintenance.



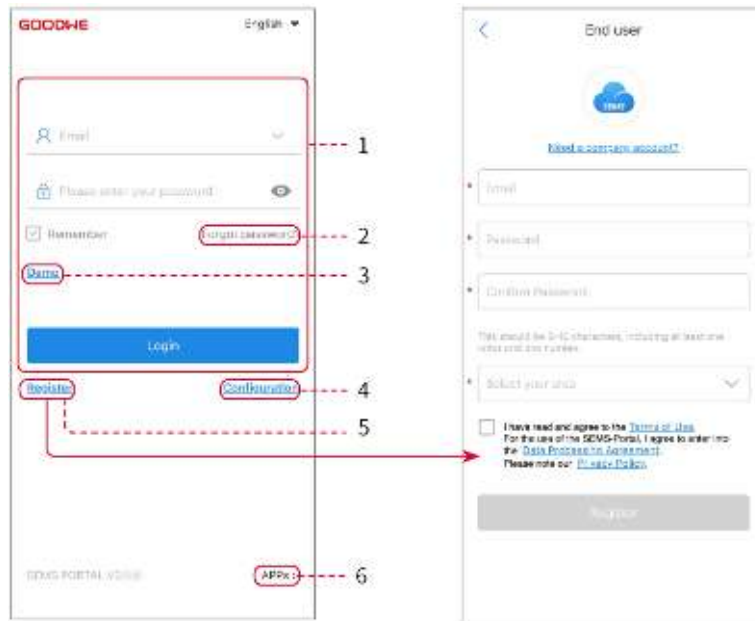

Login Page of SEMS Portal App



No.	Name	Description
1	Login Area	Enter the user name, password to login to the app.
2	Forget Password	Tap to reset the password by verifying the account.
3	Demo	Tap to enter the sample plant page. The sample page only displays contents with Visitor account, which is for reference only.
4	Configuration	Configure WiFi parameters to establish communication between the inverter and the server and realize remote monitoring and managing.
5	Register	Tap to register an end-user account. Contact the manufacturer or the company as prompted if you need a company account.
6	Demo	Tap to enter the sample plant page. The sample page only displays contents with Visitor account, which is for reference only.

Home Page of SEMS Portal App



No.	Name	Description
1		Create a new power plant.
2	Plant status	The summary of the plants working information under the account.
3	Find the plant	Find the plant by entering the plant name, device SN, Email address, or map.
4	Generation statistics	The working information of a single plant. Tap the plant name to check the detailed information of the plant, such as plant name, location, power, capacity, generation today, total generation, etc.
5	 Plants	Plant monitoring page.
6	 Alarms	Check all alarms, happening alarms, and recovered alarms.
7	 WiFi	Complete WiFi configurations when a Wi-Fi Kit dongle is used.

based on actual needs.

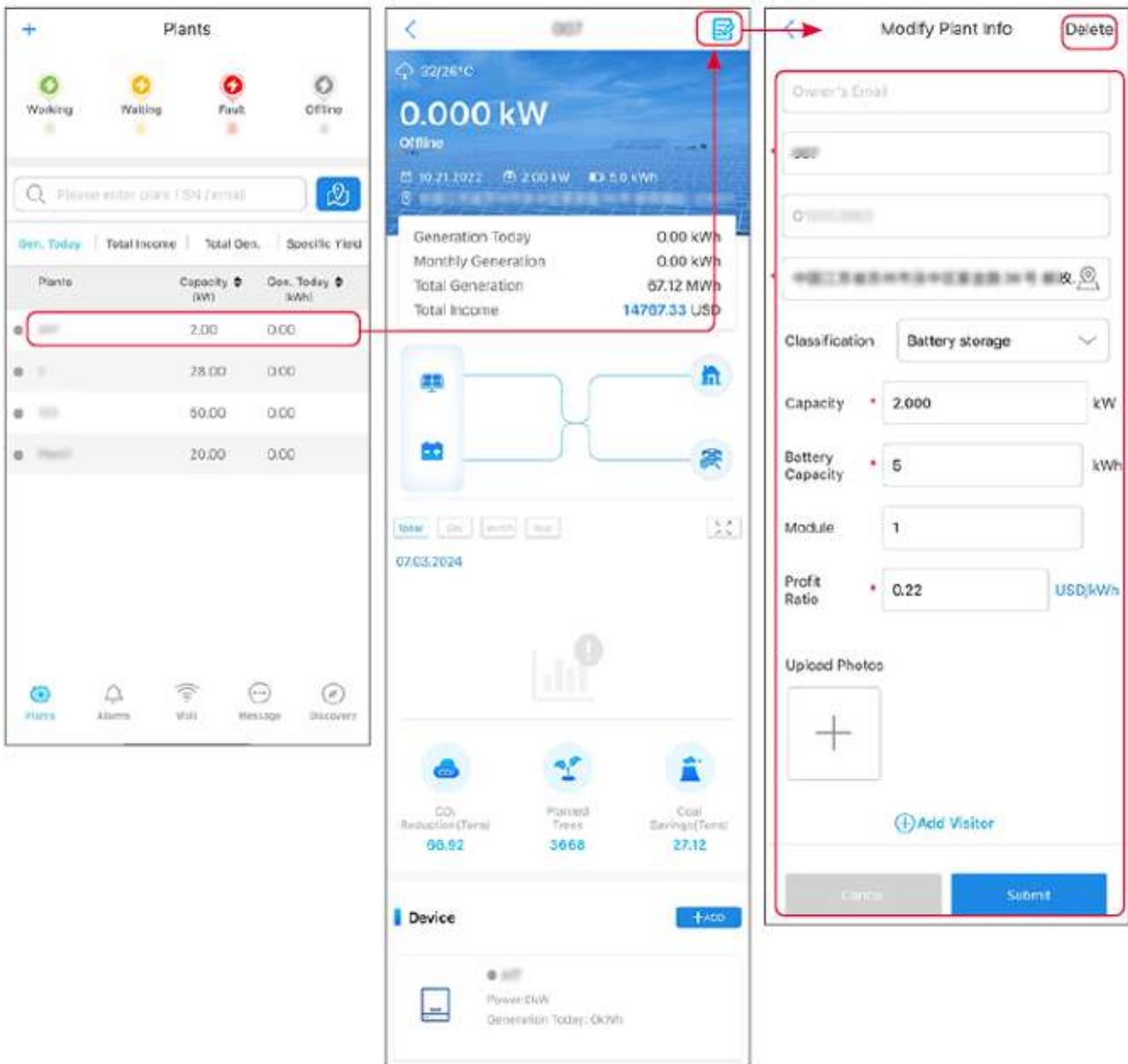

10.2.3 Managing the Devices

Step 1 Select the power plant and enter the detailed information page.

Step 2 Add, delete, or replace the devices based on actual needs.

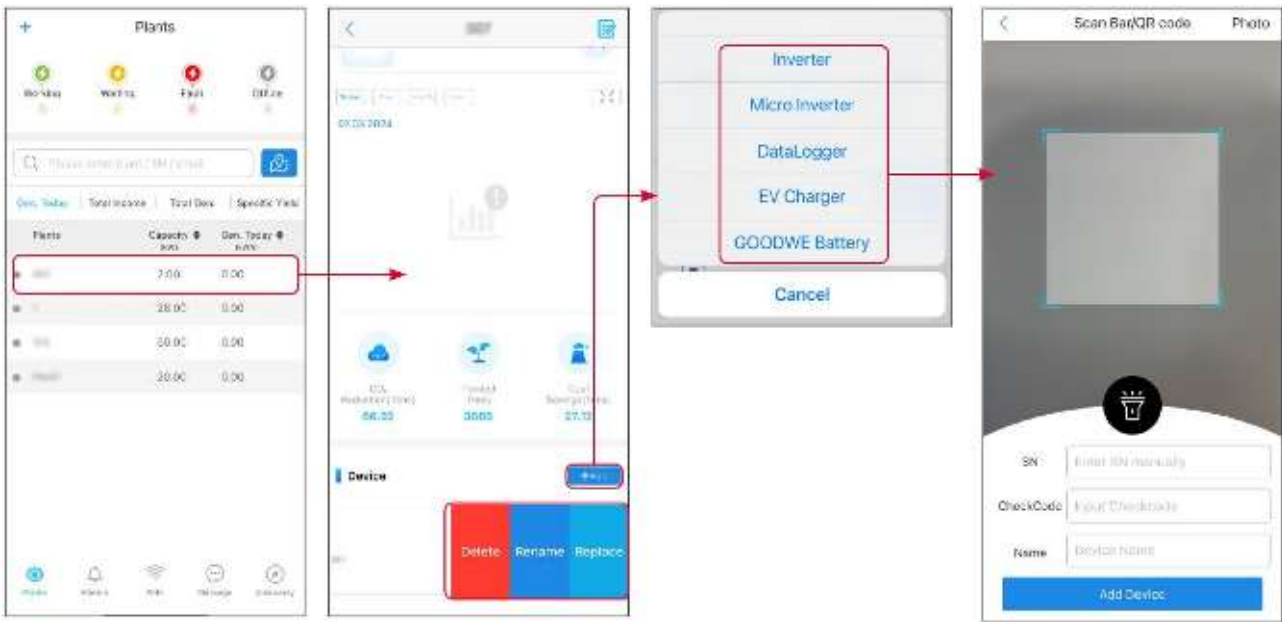

10.3 Monitoring Power Plant

10.3.1 Checking the Plant Information

Log in the SEMS Portal app with the account and password. The overall working situation of all power plants under this account will be displayed.

The interface varies depending on the devices.

Step 1: (Optional) Search the plant name, inverter SN, or Email to find out the plant quickly.

Or tap the map icon to search the plant.

Step 2 Tap the plant name in the plant list or the plant icon in the map to check detailed information about the plant.

Step 3 Check the plant information, power generation situation, device information, faults, etc.

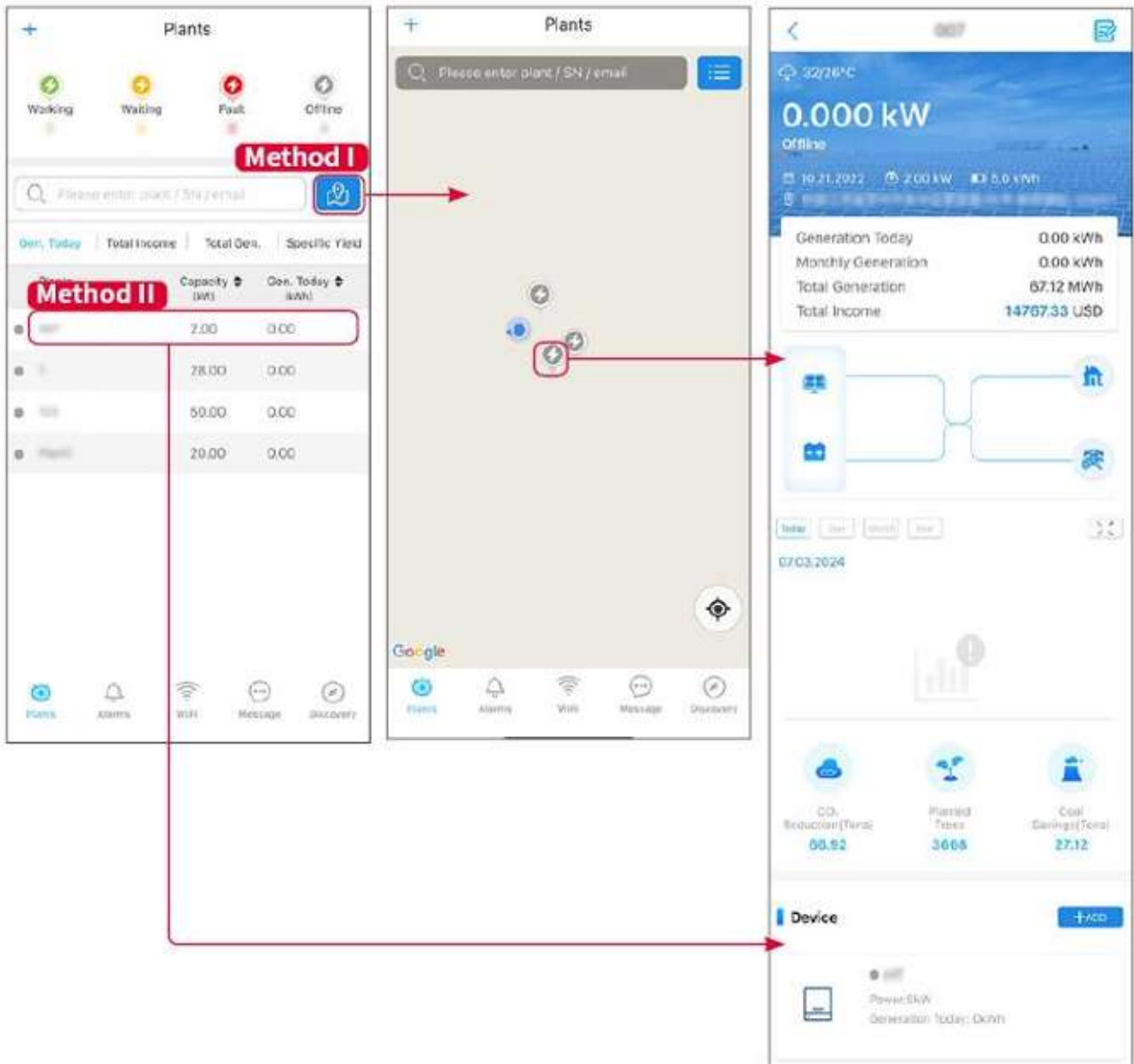

10.3.2 Viewing Alarm Information

Step 1 Tap Alarm tab and enter the Alarm Details page.

Step 2 (optional) Enter the plant name, inverter SN, or owner's Email address in the search bar to find out the plant which is alarming.

Step 3 Tap the alarm name to check the alarm details.

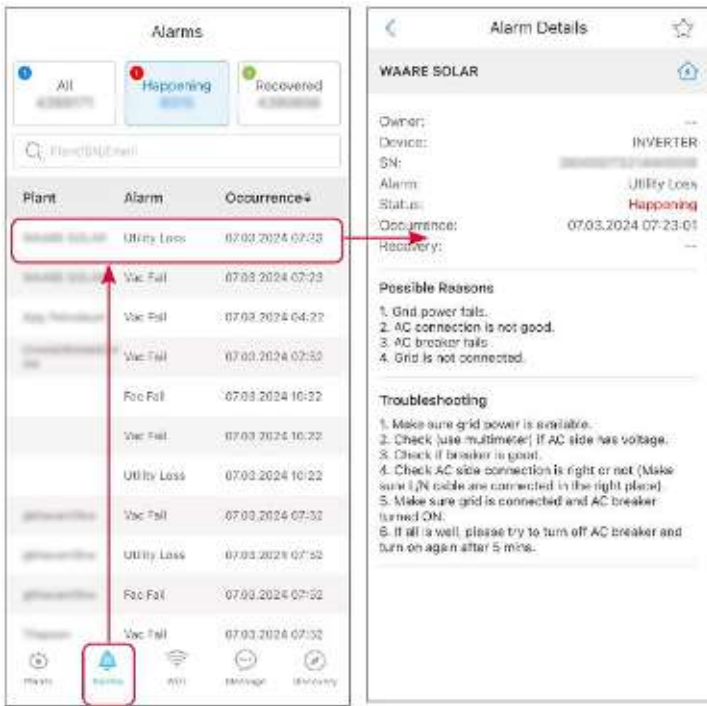

11 Maintenance

11.1 Power OFF the System

⚠ DANGER

- Power off the equipment before operations and maintenance. Otherwise, the equipment may be damaged or electric shocks may occur.
- Delayed discharge. Wait until the components are discharged after power off.
- Push the air switch to restart the battery.
- Strictly follow the power off requirements to avoid damaging the system

NOTICE

- Install the circuit breaker between the inverter and the battery or between the two batteries in compliance with local laws and regulations.
- To ensure effective protection, the cover of the battery system switch should remain closed. The cover can be closed automatically after being opened. Fasten the cover with screws if the switch is not to be used for a long-term period.

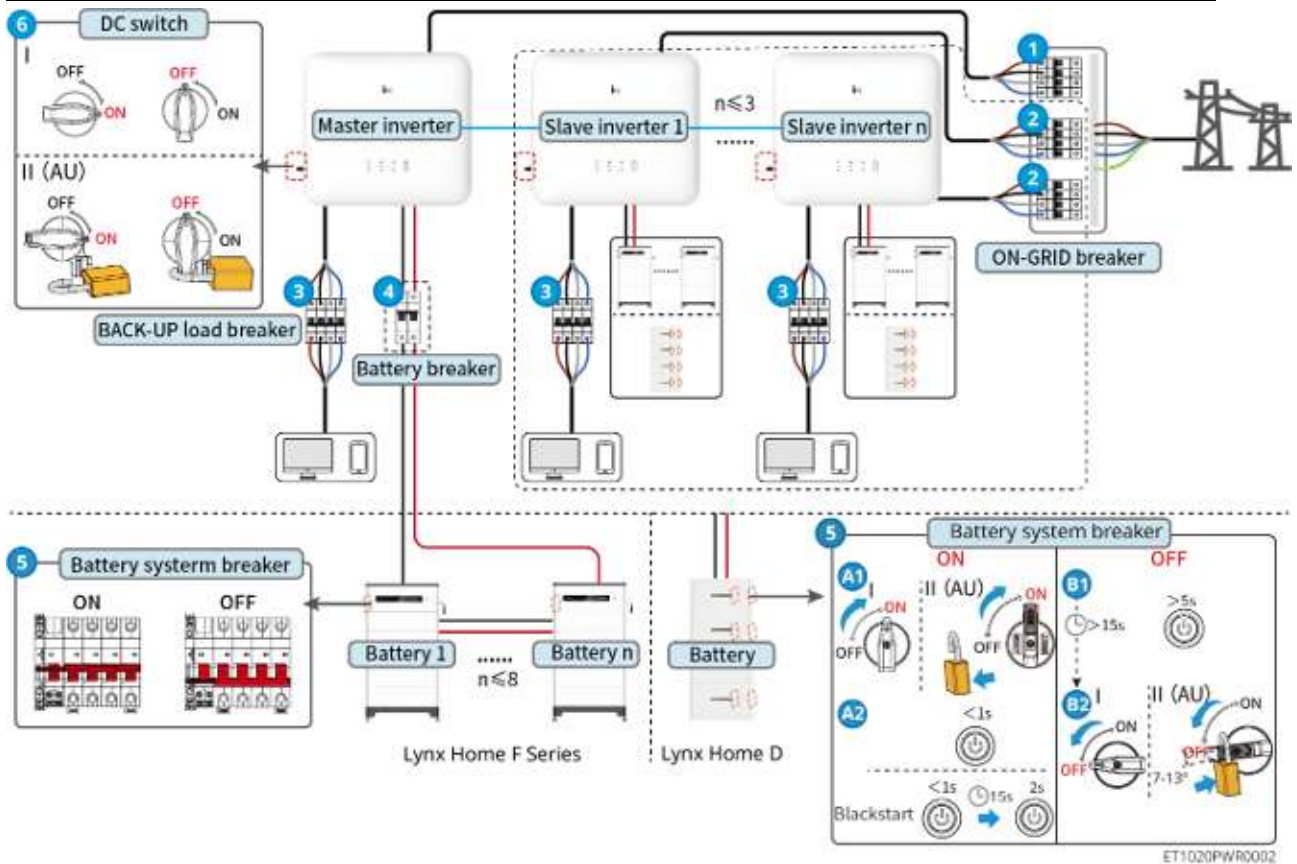

Power ON/OFF: ① → ② → ③ → ④ → ⑤ → ⑥

④ : Optional in compliance with local laws and regulations.

11.2 Removing the Equipment



- Make sure that the equipment is powered off.
- Wear proper personal protective equipment during operations.
- Use the PV tool and battery tool included in the package to remove the PV connector and battery connector.

Step 1 Power off the system.

Step 2 Tag different cable types in the system.

Step 3 Disconnect the inverter, battery, and BACK-UP loads.

Step 4 Remove the inverter from the mounting plate.

Step 5 Remove the smart meter and smart dongle.

Step 6 Store the equipment properly. If the equipment needs to be used later, ensure that the storage conditions meet the requirements.

11.3 Disposing of the Equipment

If the equipment cannot work anymore, dispose of it according to the local disposal requirements for electrical equipment waste. The equipment cannot be disposed of together with household waste.

11.4 Routine Maintenance



- Contact After Sales Service for help if you find any problems that may influence the battery or the hybrid inverter. Disassemble without permission is strictly forbidden.
- Contact after-sales service for help if the copper conductor is exposed. Do not touch or disassemble privately because high voltage danger exists.
- In case of other emergencies, contact the after-sales service as soon as possible. Operate following the instructions or wait for the after-sales service personnel.
- If you need to replace the battery or expand the capacity, please contact the dealer or after-sales personnel.

Maintaining Item	Maintaining method	Maintaining Period	Maintaining purpose
System clean	<ol style="list-style-type: none"> 1. Check the heat sink, air intake, and air outlet for foreign matter or dust. 2. Check whether the installation space meets requirements and whether there is any debris around the device. 	Once half a year	Prevent heat dissipation failures.
System installation	<ol style="list-style-type: none"> 1. Check whether the equipment are installed securely and whether 	Once 6-12 months	Ensure that the equipment is installed securely.

	the screws are installed tightly. 2. Check whether the equipment is damaged or deformed.		
Electrical connection	Check whether the cables are securely connected. Check whether the cables are broken or whether there is any exposed copper core.	Once 6-12 months	Confirm the reliability of electrical connections.
Sealing	Check whether all the terminals and ports are properly sealed. Reseal the cable hole if it is not sealed or too big.	Once a year	Confirm that the machine seal and waterproof performance are intact.

11.5 Troubleshooting

Perform troubleshooting according to the following methods. Contact the after-sales service if these methods do not work.





Collect the information below before contacting the after-sales service, so that the problems can be solved quickly.

1. Product information like serial number, software version, installation date, fault time, fault frequency, etc.
2. Installation environment, including weather conditions, whether the PV modules are sheltered or shadowed, etc. It is recommended to provide some photos and videos to assist in analyzing the problem.
3. Utility grid situation.

11.5.1 System Communication Troubleshooting

No.	Fault	Solutions
1	Cannot find router SSID	<ol style="list-style-type: none"> 1. Put the router nearer to the Smart Dongle. Or add a WiFi relay device to enhance the WiFi signal. 2. Reduce the number of devices connected to router.
2	After completing all configurations, the Smart Dongle fails connecting to the router.	<ol style="list-style-type: none"> 1. Restart the inverter 2. Check if the SSID, encryption method and password on WiFi configuration page are the same with that of Router. 3. Restart the router. 4. Put the router nearer to the Smart Dongle. Or add a WiFi relay device to enhance the WiFi signal.
3	After completing all configurations, the Smart Dongle fails connecting to the router.	Restart the router and the inverter.
4	Cannot find router SSID on searching page	<ol style="list-style-type: none"> 1. Put the router nearer to the inverter. Or add some WiFi relay devices. 2. Check if the channel number of router is higher than 13.

		3. If yes, modify it into a lower number at router configuration page.
5	Unable to find GSA-***/ GSB-**** when using 4 G Kit-CN-G20 or 4G Kit- CN-G21 module	<ol style="list-style-type: none"> 1. Please ensure that the smart dongle is powered on properly, and the blue indicator light is blinking or steady on. 2. Ensure that the smart device is within the communication range of the smart dongle. 3. Refresh the device list in the app. 4. Restart the inverter.
6	Unable to connect GSA- ***/GSB-*** when using 4G Kit-CN-G20 or 4G Ki t-CN-G21 module	<ol style="list-style-type: none"> 1. Ensure successful pairing of Bluetooth. 2. Restart the inverter and reconnect it to the GSA-***/GSB-***. 3. Unpair with GSA-***/GSB-*** in your phone's Bluetooth settings and reconnect via the app.

No.	Fault	Solutions
1	 <p>The Ezlink indicator double blinks.</p>	<ol style="list-style-type: none"> 1. Make sure that the router is powered on. 2. When communicating via LAN, make sure that both LAN cable connection and LAN configuration are proper. Enable or disable DHCP based on actual needs. 3. When communicating via WiFi, make sure that the wireless network connection is OK and the wireless signal strength meets the requirements. Enable or disable DHCP based on actual needs.
2	 <p>The Ezlink indicator blinks four times.</p>	<ol style="list-style-type: none"> 1. Make sure that the smart dongle is connected to the router via WiFi or LAN properly, and the router can access the Internet. 2. If the problem persists, contact the after sales service.
3	 <p>The Ezlink indicator is off.</p>	Make sure that the inverter is powered on. If the problem persists, contact the after sales service.
4	 <p>Indicator light blinks six times when using 4G Kit-CN-G20 or 4G Kit-CN-G21 module</p>	Please ensure that smart dongle is normally connected to the inverter.
5	 <p>The Ezlink indicator is off.</p>	Make sure that the inverter is powered on.
6	Inverter can not recognize 4G Kit-CN-G20 or 4G Kit-CN-G21	Restart the router and the inverter.

11.5.2 Inverter Troubleshooting

Single inverter

No.	Fault	Cause	Solutions
1	PV power low	Weak or abnormal changes in lighting	<ol style="list-style-type: none"> 1. If it occurs accidentally, it may be due to abnormal lighting, and the inverter will automatically resume normal operation without manual intervention. 2. Check if the battery is connected or working abnormally. 3. If the problem occurs frequently, contact the dealer or the after-sales service.
2	PV voltage Low		
3	BUS voltage Low		
4	PV Input Overvoltage	The PV array configuration is not correct. Too many PV panels are connected in series in the PV string.	Check the serial connection of the PV array. Make sure that the open circuit voltage of the PV string is not higher than the maximum operating voltage of the inverter.
5	BUS Soft Start Failure	BUS Soft Start Failure	<ol style="list-style-type: none"> 1. If it occurs accidentally, it may be due to abnormal lighting, and the inverter will automatically resume normal operation without manual intervention. 2. If the problem occurs frequently, contact the dealer or the after-sales service.
6	BAT Abnormal Connect	BAT Abnormal Connect	For battery ready models, please purchase the battery function before connecting the battery. For more information, contact the dealer or the after-sales service.
7	BAT1 Overvoltage	The battery voltage exceeds the rated range of the equipment.	Confirm if the battery voltage is within the rated range of the equipment.
8	Back-up Output Overload	Excessive power of connected load	<ol style="list-style-type: none"> 1. Confirm whether the connected load power is within the rated range of the equipment. 2. Confirm if there is insufficient light or battery power. 3. If the problem occurs frequently, contact the dealer or the after-sales service.
9	Back-up Output AC Undervoltage	<ol style="list-style-type: none"> 1. Excessive power of connected load 2. Insufficient energy on the DC side or Bus leads to low inverter voltage. 	<ol style="list-style-type: none"> 1. Confirm whether the connected load power is within the rated range of the equipment. 2. Confirm if there is insufficient light or battery power. 3. If the problem occurs frequently, contact the dealer or the after-sales service.
10	Cavity Overtemperature	<ol style="list-style-type: none"> 1. The inverter is installed in a place with poor ventilation. 2. The ambient temperature exceeds 60°C. 	<ol style="list-style-type: none"> 1. Check the ventilation and the ambient temperature at the installation point. 2. If the ventilation is poor or the ambient temperature is too high, improve the ventilation and heat dissipation. 3. Contact the dealer or after-sales service if both the ventilation and the ambient temperature are

		3. A fault occurs in the internal fan of the inverter.	normal.
11	Low Insulation Res (Earth Fault Alarm)	<ol style="list-style-type: none"> The PV string is short-circuited to PE. The PV system is in a moist environment and the cable is not well insulated to the ground. 	<ol style="list-style-type: none"> Check whether the resistance of the PV string to PE exceeds 50kΩ. If no, check the short circuit point. Check whether the PE cable is connected correctly. <p>Inverters for the Australian and New Zealand markets can also be alerted in the following ways in the event of insulation impedance failure:</p> <ul style="list-style-type: none"> The inverter is equipped with the buzzer: the buzzer sounds continuously for 1 minute in case of failure; If the fault is not resolved, the buzzer sounds every 30 minutes. Add the inverter to the monitoring platform, and set the alarm reminder, the alarm information can be sent to the customer by emails.
12	DC Arc Fault	<ol style="list-style-type: none"> The DC terminal is not firmly connected. The DC cable is broken. 	Read the guide or manual and check whether the cables are connected properly.
13	CPLD Protection	CPLD protection triggering fault	<ol style="list-style-type: none"> If it happens by chance, no manual intervention is required. If the problem occurs frequently, contact the dealer or the after-sales service.
14	DC SPD Failure	DC side lightning protection device failure	<ol style="list-style-type: none"> Improve the lightning protection facilities around the inverter. You can determine whether it is necessary to contact the dealer/after-sales service to handle DC side lightning protection device faults based on needs. If it is confirmed that there is no need to handle it, the lightning protection alarm can be turned off in the basic settings of the SolarGo App. Disconnect the AC output switch and DC input switch, then connect them 5 minutes later. Contact the dealer or the after-sales service if the problem persists.
15	Utility Loss	<ol style="list-style-type: none"> Utility grid power fails. The AC cable is disconnected, or the AC breaker is off. 	<ol style="list-style-type: none"> The alarm is automatically cleared after the grid power supply is restored. Check whether the AC cable is connected and the AC breaker is on.
16	Grid Overvoltage	The grid voltage exceeds the permissible range, or the duration of high voltage exceeds the requirement of HVRT.	<ol style="list-style-type: none"> If the problem occurs occasionally, the utility grid may be abnormal temporarily. The inverter will recover automatically after detecting that the utility grid is normal. If the problem occurs frequently, check whether the grid voltage is within the permissible range. <ul style="list-style-type: none"> Contact the local power company if the grid voltage exceeds the permissible range. Modify the overvoltage protection threshold, HVRT or disable the overvoltage protection function after obtaining the consent of the local power company if the grid frequency is

			<p>within the permissible range.</p> <p>3. Check whether the AC breaker and the output cables are connected securely and correctly if the problem persists.</p>
17	Grid Rapid Overvoltage	The grid voltage is abnormal or ultrahigh.	<p>1. If the problem occurs occasionally, the utility grid may be abnormal temporarily. The inverter will recover automatically after detecting that the utility grid is normal.</p> <p>2. If the problem occurs frequently, check whether the grid voltage is within the allowed range.</p> <ul style="list-style-type: none"> ● Contact the local power company if the grid voltage exceeds the permissible range. ● Modify the grid overvoltage rapid protection threshold after obtaining the consent of the local power company if the grid voltage is within the permissible range.
18	Grid Undervoltage	The grid voltage is lower than the permissible range, or the duration of low voltage exceeds the requirement of LVRT.	<p>1. If the problem occurs occasionally, the utility grid may be abnormal temporarily. The inverter will recover automatically after detecting that the utility grid is normal.</p> <p>2. If the problem occurs frequently, check whether the grid voltage is within the permissible range.</p> <ul style="list-style-type: none"> ● Contact the local power company if the grid voltage exceeds the permissible range. ● Modify the undervoltage protection threshold, LVRT or disable the undervoltage protection function after obtaining the consent of the local power company if the grid frequency is within the permissible range. <p>3. Check whether the AC breaker and the output cables are connected securely and correctly if the problem persists.</p>
19	Grid 10min Overvoltage	The moving average of grid voltage in 10min exceeds the range of safety requirements.	<p>1. If the problem occurs occasionally, the utility grid may be abnormal temporarily. The inverter will recover automatically after detecting that the utility grid is normal.</p> <p>2. If the problem occurs frequently, check whether the grid voltage is within the allowed range.</p> <ul style="list-style-type: none"> ● Contact the local power company if the grid voltage exceeds the permissible range. ● Modify the grid overvoltage rapid protection threshold after obtaining the consent of the local power company if the grid voltage is within the permissible range.
20	Grid Overfrequency	Utility grid exception. The actual grid frequency exceeds the requirement of the local grid standard.	<p>1. If the problem occurs occasionally, the utility grid may be abnormal temporarily. The inverter will recover automatically after detecting that the utility grid is normal.</p> <p>2. If the problem occurs frequently, check whether the grid frequency is within the permissible range.</p> <ul style="list-style-type: none"> ● Contact the local power company if the grid frequency exceeds the permissible range.

			<ul style="list-style-type: none"> ● Modify the overfrequency protection threshold or disable the overfrequency protection function after obtaining the consent of the local power company if the grid frequency is within the permissible range.
21	Grid Underfrequency	Utility grid exception. The actual grid frequency is lower than the requirement of the local grid standard.	<ol style="list-style-type: none"> 1. If the problem occurs occasionally, the utility grid may be abnormal temporarily. The inverter will recover automatically after detecting that the utility grid is normal. 2. If the problem occurs frequently, check whether the grid frequency is within the permissible range. <ul style="list-style-type: none"> ● Contact the local power company if the grid frequency exceeds the permissible range. ● Modify the underfrequency protection threshold or disable the underfrequency protection function after obtaining the consent of the local power company if the grid frequency is within the permissible range. Or close Grid Underfrequency function.
22	Grid Frequency Instability	Utility grid exception. The actual grid frequency change rate does not meet the requirement of the local grid standard.	<ol style="list-style-type: none"> 1. If the problem occurs occasionally, the utility grid may be abnormal temporarily. The inverter will recover automatically after detecting that the utility grid is normal. 2. If the problem occurs frequently, check whether the grid frequency is within the permissible range. <ul style="list-style-type: none"> ● Contact the local power company if the grid frequency exceeds the permissible range. ● Contact the dealer or the after-sales service if the grid frequency is within the permissible range.
23	Anti-islanding	The utility grid is disconnected. The utility grid is disconnected according to the safety regulations, but the grid voltage is maintained due to the loads.	<ol style="list-style-type: none"> 1. Check whether the utility grid is disconnected. 2. Contact the dealer or the after-sales service.
24	LVRT Undervoltage	1. Utility grid exception. The duration of the utility grid exception exceeds the set time of LVRT.	<ol style="list-style-type: none"> 1. If the problem occurs occasionally, the utility grid may be abnormal temporarily. The inverter will recover automatically after detecting that the utility grid is normal. 2. If the problem occurs frequently, check whether the grid voltage is within the permissible range. If not, contact the local power company. If yes, contact the dealer or the after-sales service.
25	HVRT Overvoltage	Utility grid exception. The duration of utility grid exception exceeds the set time of HVRT.	
26	Abnormal GFCI 30mA	The input insulation impedance becomes low when the inverter	<ol style="list-style-type: none"> 1. If the problem occurs occasionally, it may be caused by a cable exception. The inverter will recover automatically after the problem is solved.
27	Abnormal		

	GFCI 60mA	is working.	2. Check whether the impedance between the PV string and PE is too low if the problem occurs frequently or persists.
28	Abnormal GFCI 150mA		
29	Abnormal GFCI		
30	Large DC of AC current L1	The DC component of the output current exceeds the safety range or default range.	1. If the problem is caused by an external fault like a utility grid exception or frequency exception, the inverter will recover automatically after solving the problem. 2. If the problem occurs frequently and the PV station cannot work properly, contact the dealer or the after-sales service.
31	Large DC of AC current L2		
32	Relay Chk Fail	1. Relay Dev Fail 2. The control circuit is abnormal. 3. The AC cable is connected improperly, like a virtual connection or short circuit.	Disconnect the AC output switch and DC input switch, then connect them 5 minutes later. Contact the dealer or the after-sales service if the problem persists.
33	BUS Overvoltage	1. The PV voltage is too high. 2. The sampling of the inverter BUS voltage is abnormal.	Disconnect the AC output switch and DC input switch, then connect them 5 minutes later. Contact the dealer or the after-sales service if the problem persists.
34	Internal Comm Loss	1. Frame format error 2. Parity checking error 3. Can bus offline 4. Hardware CRC error 5. Send (receive) control bit is receive (send). 6. Transmit to the unit that is not allowed.	Disconnect the AC output switch and DC input switch, then connect them 5 minutes later. Contact the dealer or the after-sales service if the problem persists.
35	PV Software Overcurrent	Abnormal changes in lighting or the PV panel is far from the inverter.	1. If it occurs accidentally, it may be due to abnormal lighting, and the inverter will automatically resume normal operation without manual intervention. 2. If the problem occurs frequently, contact the dealer or the after-sales service.
36	The PV strings are connected reversely.	The PV strings are connected reversely.	Check whether the PV1 and PV2 strings are connected reversely.
37	PV Continuous Hardware Overcurrent	1. The PV configuration is not proper.	Disconnect the AC output switch and DC input switch, then connect them 5 minutes later. Contact the dealer or the after-sales service if the problem persists.

38	PV Continuous Software Overcurrent	2. The hardware is damaged.	
39	Battery Reverse Connection Fault	Reverse connection of positive and negative electrodes of the battery.	Check if the positive and negative terminal connections between the battery and the inverter side battery are correct.
40	BUS Voltage Imbalance	1. Abnormal load access 2. Hardware problem	1. If it occurs accidentally, it may be due to abnormal lighting, and the inverter will automatically resume normal operation without manual intervention. 2. If the problem occurs frequently, contact the dealer or the after-sales service.
41	Inv Software Overcurrent	Short time sudden changes in the power grid or load leading to control overcurrent.	1. If the problem occurs occasionally, the utility grid may be abnormal temporarily. The inverter will recover automatically after detecting that the utility grid is normal. 2. If the problem occurs frequently, contact the dealer or the after-sales service.
42	Back-up Output Loss	Abnormal inverter sampling circuit Hardware problem	Disconnect the AC output switch and DC input switch, then connect them 5 minutes later. Contact the dealer or the after-sales service if the problem persists.
43	Back-up Output AC Overvoltage		
44	AC HCT Fail	The sampling of the AC HCT is abnormal.	Disconnect the AC output switch and DC input switch, then connect them 5 minutes later. Contact the dealer or the after-sales service if the problem persists.
45	GFCI HCT Failure	The sampling of the GFCI HCT is abnormal.	Disconnect the AC output switch and DC input switch, then connect them 5 minutes later. Contact the dealer or the after-sales service if the problem persists.
46	AFCI Self-test Fault	AFCI detection is abnormal.	Disconnect the AC output switch and DC input switch, then connect them 5 minutes later. Contact the dealer or the after-sales service if the problem persists.
47	Flash Fault	The internal Flash storage is abnormal.	Disconnect the AC output switch and DC input switch, then connect them 5 minutes later. Contact the dealer or the after-sales service if the problem persists.
48	1.5V Ref abnormal	Reference circuit fault	Disconnect the AC output switch and DC input switch, then connect them 5 minutes later. Contact the dealer or the after-sales service if the problem persists.
49	0.3V Ref abnormal		
50	External fan abnormal	Possible cause of external fan abnormal: 1. The power supply to the fan is abnormal. 2. Mechanical failure (blocked rotation). 3. Fan aging	Disconnect the AC output switch and DC input switch, then connect them 5 minutes later. Contact the dealer or the after-sales service if the problem persists.

		damage.	
--	--	---------	--

Parallel System

No.	Fault	Cause	Solutions
1	Abnormal parallel CAN communication	The parallel communication cable connection is abnormal, or an inverter in the parallel system is offline.	Check whether all the inverters are powered on and whether the parallel communication cables are firmly connected.

11.5.3 Battery Troubleshooting

Common faults













No.	Fault	Cause	Solutions
1	Battery system tilt	The ground is uneven or deformed.	Place the battery on a flat and hard ground.
2	Indicator light goes out during operation	Cable short circuit or internal failure of battery system.	<ol style="list-style-type: none"> 1. Check for short circuits in external cables. 2. Turn off the battery system and wait for 2 hours, then turn it on.
3	Button indicator light turns to red and flashes, and the SOC light displays battery percentage.	<ul style="list-style-type: none"> ● Communication cable fault. ● The battery model set in SolarGo App is incorrect. 	<ol style="list-style-type: none"> 1. Check if the communication cables are correct. 2. Check if the inverter is working properly. 3. Set correct battery system model through the SolarGo App.





















When the button indicator turns to red, check the SOC indicator status to find out the fault.





Lynx Home F, Lynx Home F PLUS+

No.	SOC indicator	Fault	Solutions
1		Battery Overvoltage	Restart the battery. If the problem persists, please contact the after-sales service.
2		Battery Undervoltage	Long press the button for 5 seconds to start the battery under charging conditions. If the problem persists, contact the after-sales service.
3		Overcurrent Charging	Restart the battery. If the problem persists, please contact the after-sales service.
4		Overcurrent Discharging	Restart the battery. If the problem persists, please contact the after-sales service.
5		Temperature Difference Exception	Power off and wait for 2 hours. If the problem persists, please contact the after-sales service.

6		High Temperature	Power off and wait for 2 hours. If the problem persists, please contact the after-sales service.
7		Low Temperature	Power off and wait for 2 hours. If the problem persists, please contact the after-sales service.
8		Inconsistent Software Version	Contact the after-sales service.
9		Precharge Fault	Restart the battery. If the problem persists, please contact the after-sales service.
10		Relay Dev Fail	Restart the battery. If the problem persists, please contact the after-sales service.
11		Air Switch Fault	Restart the battery. If the problem persists, please contact the after-sales service.
12		Insulation Fault	Do not touch the battery and contact the after-sales service.
13		Internal Communication Fault	Power off and check the communication cables. Restart the battery. If the problem persists, contact the after-sales service.
14		SN Fault	Contact the after-sales service.
15		Voltage Balance Fault	Restart the battery. If the problem persists, please contact the after-sales service.
16		Inconsistent Master and Slave	Restart the battery. If the problem persists, please contact the after-sales service.
17		Temp. Sensor Fault	Restart the battery. If the problem persists, please contact the after-sales service.
18		Others	Contact the after-sales service.



Lynx home F G2

No.	SOC indicator	Fault	Solutions
1		Battery Overvoltage	Power off and wait for 2 hours. If the problem persists, please contact the after-sales service.
2		Battery Undervoltage	Contact the after-sales service.
3		High Cell Temperature	<ol style="list-style-type: none"> 1. There are heat sources around the battery system, such as open flames, boilers, or other heating devices. Keep the battery system away from heat sources. 2. Power off the battery and wait for the temperature to recover before powering it on again. If the problem persists, please contact the after-sales service.
4		Excessive Temperature Difference	
5		Low Charging Temperature	<ol style="list-style-type: none"> 1. The environment temperature is too low. Check the environment to ensure that the installation temperature of the battery system meets the operating temperature range of the battery. 2. Power off the battery and wait for the temperature to recover before powering it on again.
6		Low Discharging Temperature	
7		Overcurrent Charging	Restart the battery. If the problem persists, please contact the after-sales service.
8		Overcurrent Discharging	Restart the battery. If the problem persists, please contact the after-sales service.
9		Low Insulation Resistance	Contact the after-sales service.
10		Voltage Difference Exception	Restart the battery and leave it for 12 hours. If the problem persists, please contact the after-sales service.
11		Inconsistent Cell	Some battery modules in the battery system have incorrect models. Please contact the dealer to replace the battery module and reinstall it.
12		Wire Harness Exception	Restart the battery. If the problem persists, please contact the after-sales service.
13		Relay Connection Failure	Restart the battery. If the problem persists, please contact the after-sales service.
14		Relay Adhesion	Restart the battery. If the problem persists, please contact the after-sales service.
15		Cluster Fault	Check the battery model. Contact the after-sale service if the battery model is incorrect.
16		Interlock Failure	Check whether the termination resistor is installed properly and restart the battery. If the problem persists, please contact the after-sales service.
17		BMU Communication Fault	Restart the battery. If the problem persists, please contact the after-sales service.
18		MCU Communication Fault	Restart the battery. If the problem persists, please contact the after-sales service.
19		Air Switch	Contact the after-sales service.

		Adhesion	
20		Precharge Failure	Restart the battery. If the problem persists, please contact the after-sales service.
21		Relay Overtemperature	Power off and wait for 2 hours. If the problem persists, please contact the after-sales service.
22		Current Diverter Overtemperature	Power off and wait for 2 hours. If the problem persists, please contact the after-sales service.
23		Reverse Connection Fault	The positive and negative poles of the battery system power cable are reversed. Please reconnect the power cable.
24		Microelectronic Fault	Contact the after-sales service.





When the button indicator turns to red and blink 1 times/s, check the SOC indicator status to find out the fault.

No.	SOC indicator	Fault	Solutions
1		Battery Overvoltage	Power off and wait for 2 hours. Contact the after-sale service if the problem persists.
2		Battery Undervoltage	Contact the after-sale service.
3	Display the current battery level of the battery system	Battery overcurrent	Restart the battery. Contact the after-sale service if the problem persists.
4	Display the current battery level of the battery system	Excessive temperature difference	<ol style="list-style-type: none"> 1. Check the environment to ensure that the installation temperature of the battery system meets the operating temperature range of the battery. 2. Power off the battery and wait for the temperature to recover before powering it on again.
5	Display the current battery level of the battery system	Excessive pressure difference	Restart the battery and leave it for 12 hours. Contact the after-sale service if the problem persists
6	Display the current battery level of the battery system	Lost communication with inverter	<ol style="list-style-type: none"> 1. Check if the communication between the battery and the inverter is normal. 2. Restart the battery. Contact the after-sale service if the problem persists.

Lynx home D

No.	SOC indicator	Fault	Solutions
1		Battery Overvoltage	Power off and wait for 2 hours. If the problem persists, please contact the after-sales service.
2		Battery Undervoltage	Contact the after-sales service.
3		High Cell Temperature	Power off and wait for 2 hours. If the problem persists, please contact the after-sales service.
4		Low Charging Temperature	Power off and wait for the temperature recovers. If the problem persists, please contact the after-sales service.
5		Low Discharging Temperature	
6		Overcurrent Charging	Restart the battery. If the problem persists, please contact the after-sales service.
7		Overcurrent Discharging	
8		Excessive Temperature Difference	Power off and wait for 2 hours. If the problem persists, please contact the after-sales service.
9		Voltage Difference Exception	Restart the battery and leave it for 12 hours. If the problem persists, please contact the after-sales service.
10		Wire Harness Exception	Restart the battery. If the problem persists, please contact the after-sales service.
11		MOS cannot be closed	Restart the battery. If the problem persists, please contact the after-sales service.
12		MOS adhesion	Restart the battery. If the problem persists, please contact the after-sales service.
13		Cluster Fault	Check the battery model. Contact the after-sale service if the battery model is incorrect.
14		BMU Communication Fault	Restart the battery. If the problem persists, please contact the after-sales service.
15		MCU Communication Fault	Restart the battery. If the problem persists, please contact the after-sales service.
16		Precharge Failure	Restart the battery. If the problem persists, please contact the after-sales service.
17		MOS overtemperature fault	Power off and wait for 2 hours. If the problem persists, please contact the after-sales service.
18		Current Diverter Overtemperature	Power off and wait for 2 hours. If the problem persists, please contact the after-sales service.

19		BMS Hardware Overcurrent Fault	Power off and wait for 2 hours. If the problem persists, please contact the after-sales service.
20		DCDC Fault	Power off and wait for 2 hours. If the problem persists, please contact the after-sales service.
21		Microelectronic Fault	Contact the after-sales service.
22	Button indicator blinks red and SOC indicator off	Inverter communication loss	Check if the inverter communication cable is normal. If the problem persists after reconnecting, please contact the after-sales service.

12 Parameters

12.1 Inverter Parameters

Technical Data	GW6000-ET-20	GW8000-ET-20	GW9900-ET-20
Battery Input Data			
Battery Type	Li-Ion	Li-Ion	Li-Ion
Nominal Battery Voltage (V)	500	500	500
Battery Voltage Range (V)	150~720	150~720	150~720
Start-up Voltage (V)	150	150	150
Number of Battery Input	1	1	1
Max. Continuous Charging Current (A)	30	30	40
Max. Continuous Discharging Current (A)	30	30	40
Max. Charge Power (W)	9,000	12,000	15,000
Max. Discharge Power (W)	6,600	8,800	11,000
PV String Input Data			
Max. Input Power (W) *1	9,600	12,800	16,000
Max. Input Voltage (V) *2	1000	1000	1000
MPPT Operating Voltage Range (V)	120~850	120~850	120~850
MPPT Voltage Range at Nominal Power (V)	220~850	285~850	260~850
Start-up Voltage (V)	150	150	150
Nominal Input Voltage (V)	620	620	620
Max. Input Current per MPPT (A)	16	16	16
Max. Short Circuit Current per MPPT (A)	24	24	24
Max. Backfeed Current to The Array (A)	0	0	0
Number of MPP Trackers	2	2	3
Number of Strings per MPPT	1	1	1
AC Output Data (On-grid)			
Nominal Output Power (W)	6,000	8,000	9,990
Max. Output Power (W)	6,000	8,000	9,990
Nominal Apparent Power Output to Utility Grid (VA)	6,000	8,000	9,990
Max. Apparent Power Output to Utility Grid (VA) *3	6,000	8,000	9,990
Nominal Apparent Power from Utility Grid (VA)	6,000	8,000	10,000

Max. Apparent Power from Utility Grid (VA)	12,000	16,000	20,000
Nominal Output Voltage (V)	400/380, 3L/N/PE		
Output Voltage Range (V) *4	170~290	170~290	170~290
Nominal AC Grid Frequency (Hz)	50/60	50/60	50/60
AC Grid Frequency Range (Hz)	45~65	45~65	45~65
Max. AC Current Output to Utility Grid (A) *5	8.7	11.6	14.5
Max. AC Current From Utility Grid (A)	15.7	21.0	26.1
Max. Output Fault Current (Peak and Duration) (A)	200Aat1ms	200Aat1ms	200Aat1ms
Inrush Current (Peak and Duration) (A)	150Aat1ms	150Aat1ms	150Aat1ms
Nominal Output Current (A)	8.7	11.6	14.3
Power Factor	0.8 leading~0.8 lagging		
Max. Total Harmonic Distortion	<3%		
Maximum Output Overcurrent Protection (A)	56		
AC Output Data (Back-up)			
Back-up Nominal Apparent Power (VA)	6,000	8,000	10,000
Max. Output Apparent Power (VA) *6	6,000 (12,000 at60sec)	8,000 (16,000 at60sec)	10,000 (18000 at60sec)
Max. Output Apparent Power with Grid (VA)	6,000	8,000	10,000
Nominal Output Current (A)	8.7	11.6	14.5
Max. Output Current (A)	13.0 (17.4at60sec)	17.4 (23.3at60sec)	21.7 (26.1at60sec)
Max. Output Fault Current (Peak and Duration) (A)	56at3us	56at3us	56at3us
Inrush Current (Peak and Duration) (A)	150Aat1ms	150Aat1ms	150Aat1ms
Maximum Output Overcurrent Protection (A)	56	56	56
Nominal Output Voltage (V)	400/380	400/380	400/380
Nominal Output Frequency (Hz)	50/60	50/60	50/60
Output THDv (@Linear Load)	<3%	<3%	<3%
Efficiency			
Max. Efficiency	98.0%	98.0%	98.2%
European Efficiency	97.2%	97.2%	97.5%
Max. Battery to AC Efficiency	97.2%	97.5%	97.5%
MPPT Efficiency	99.5%	99.5%	99.5%
Protection			

PV Insulation Resistance Detection	Integrated	Integrated	Integrated
PV AFCI3.0	Integrated	Integrated	Integrated
Residual Current Monitoring	Integrated	Integrated	Integrated
PV Reverse Polarity Protection	Integrated	Integrated	Integrated
Battery Reverse Polarity Protection	Integrated	Integrated	Integrated
Anti-islanding Protection	Integrated	Integrated	Integrated
AC Overcurrent Protection	Integrated	Integrated	Integrated
AC Short Circuit Protection	Integrated	Integrated	Integrated
AC Overvoltage Protection	Integrated	Integrated	Integrated
DC Switch	Integrated	Integrated	Integrated
DC Surge Protection	Type II	Type II	Type II
AC Surge Protection	Type II	Type II	Type II
Remote Shutdown	Integrated	Integrated	Integrated
General Data			
Operating Temperature Range (°C)	-35~+60	-35~+60	-35~+60
Storage Temperature (°C)	-40~+85	-40~+85	-40~+85
Relative Humidity	0~100%	0~100%	0~100%
Operating Environment	Outdoor	Outdoor	Outdoor
Max. Operating Altitude (m)	4000	4000	4000
Cooling Method	Natural Convection	Natural Convection	Natural Convection
User Interface	LED, WLAN+APP	LED, WLAN+APP	LED, WLAN+APP
Communication with BMS	RS485, CAN	RS485, CAN	RS485, CAN
Communication with Meter	RS485	RS485	RS485
Communication with Portal	LAN(4G optional)+ Bluetooth+WiFi	LAN(4G optional)+ Bluetooth+WiFi	LAN(4G optional)+ Bluetooth+WiFi
Weight (kg)	23	23	25
Dimension (WxHxD mm)	496*460*221	496*460*221	496*460*221
Noise Emission (dB)	<30	<30	<30
Topology	Non-isolated	Non-isolated	Non-isolated
Self-consumption at Night (W) ^{*7}	<15	<15	<15
Ingress Protection Rating	IP66	IP66	IP66
DC Connector	MC4 (4~6mm ²)	MC4 (4~6mm ²)	MC4 (4~6mm ²)
AC Connector	Feed-Through Terminal Blocks UW10	Feed-Through Terminal Blocks UW10	Feed-Through Terminal Blocks UW10
Environmental Category	4K4H	4K4H	4K4H
Pollution Degree	III	III	III
Overvoltage Category	DC II / AC III	DC II / AC III	DC II / AC III
Protective Class	I	I	I

The Decisive Voltage Class (DVC)	Battery: C PV: C AC: C Com: A	Battery: C PV: C AC: C Com: A	Battery: C PV: C AC: C Com: A
Mounting Method	Wall Mounted	Wall Mounted	Wall Mounted
Active Anti-islanding Method ⁸	AFDPF + AQDPF	AFDPF + AQDPF	AFDPF + AQDPF
Type of Electrical Supply System	Three phase Grid	Three phase Grid	Three phase Grid
Country of Manufacture	China	China	China
Certification ⁹			
Grid Standards	VDE-AR-N 4105, EN50549-1		
Safety Regulation	IEC62109-1&2		
EMC	EN61000-6-1, EN61000-6-2, EN61000-6-3, EN61000-6-4		

Technical Data	GW10K-ET-20	GW12K-ET-20	GW15K-ET-20
Battery Input Data			
Battery Type	Li-Ion	Li-Ion	Li-Ion
Nominal Battery Voltage (V)	500	500	500
Battery Voltage Range (V)	150~720	150~720	150~720
Start-up Voltage (V)	150	150	150
Number of Battery Input	1	1	1
Max. Continuous Charging Current (A)	40	40	40
Max. Continuous Discharging Current (A)	40	40	40
Max. Charge Power (W)	15,000	18,000	24,000
Max. Discharge Power (W)	11,000	13,200	16,500
PV String Input Data			
Max. Input Power (W) *1	16,000	19,200	24,000
Max. Input Voltage (V) *2	1000	1000	1000
MPPT Operating Voltage Range (V)	120~850	120~850	120~850
MPPT Voltage Range at Nominal Power (V)	260~850	285~850	380~850
Start-up Voltage (V)	150	150	150
Nominal Input Voltage (V)	620	620	620
Max. Input Current per MPPT (A)	16	16	16
Max. Short Circuit Current per MPPT (A)	24	24	24

Max. Backfeed Current to The Array (A)	0	0	0
Number of MPP Trackers	3	3	3
Number of Strings per MPPT	1	1	1
AC Output Data (On-grid)			
Nominal Output Power (W)	10,000	12,000	15,000
Max. Output Power (W)	10,000	12,000	15,000
Nominal Apparent Power Output to Utility Grid (VA)	10,000	12,000	15,000
Max. Apparent Power Output to Utility Grid (VA) ^{*3}	10,000	12,000	15,000
Nominal Apparent Power from Utility Grid (VA)	10,000	12,000	15,000
Max. Apparent Power from Utility Grid (VA)	20,000	20,000	20,000
Nominal Output Voltage (V)	400/380, 3L/N/PE	400/380, 3L/N/PE	400/380, 3L/N/PE
Output Voltage Range (V) *4	170~290	170~290	170~290
Nominal AC Grid Frequency (Hz)	50/60	50/60	50/60
AC Grid Frequency Range (Hz)	45~65	45~65	45~65
Max. AC Current Output to Utility Grid (A) ^{*5}	14.5	17.4	21.7
Max. AC Current From Utility Grid (A)	26.1	26.1	26.1
Max. Output Fault Current (Peak and Duration) (A)	200Aat1ms	200Aat1ms	200Aat1ms
Power Factor	150Aat1ms	150Aat1ms	150Aat1ms
Max. Total Harmonic Distortion	14.5	17.4	21.7
Power Factor	0.8 leading~0.8 lagging		
Max. Total Harmonic Distortion	<3%		
Maximum Output Overcurrent Protection (A)	56		
AC Output Data (Back-up)			
Back-up Nominal Apparent Power (VA)	10,000	12,000	15,000
Max. Output Apparent Power (VA) ^{*6}	10,000 (18000 at60sec)	12,000 (18000 at60sec)	15,000 (18000 at60sec)
Max. Output Apparent Power with Grid (VA)	10,000	12,000	15,000
Nominal Output Current (A)	14.5	17.4	21.7
Max. Output Current (A)	21.7 (26.1at60sec)	21.7 (26.1at60sec)	21.7 (26.1at60sec)
Max. Output Fault Current (Peak and Duration) (A)	56at3us	56at3us	56at3us
Inrush Current (Peak and Duration) (A)	150Aat1ms	150Aat1ms	150Aat1ms

Maximum Output Overcurrent Protection (A)	56	56	56
Nominal Output Voltage (V)	400/380	400/380	400/380
Nominal Output Frequency (Hz)	50/60	50/60	50/60
Output THDv (@Linear Load)	<3%	<3%	<3%
Efficiency			
Max. Efficiency	98.2%	98.2%	98.2%
European Efficiency	97.5%	97.5%	97.5%
Max. Battery to AC Efficiency	97.5%	97.5%	97.5%
MPPT Efficiency	99.5%	99.5%	99.5%
Protection			
PV Insulation Resistance Detection	Integrated	Integrated	Integrated
PV AFCI3.0	Integrated	Integrated	Integrated
Residual Current Monitoring	Integrated	Integrated	Integrated
PV Reverse Polarity Protection	Integrated	Integrated	Integrated
Battery Reverse Polarity Protection	Integrated	Integrated	Integrated
Anti-islanding Protection	Integrated	Integrated	Integrated
AC Overcurrent Protection	Integrated	Integrated	Integrated
AC Short Circuit Protection	Integrated	Integrated	Integrated
AC Overvoltage Protection	Integrated	Integrated	Integrated
DC Switch	Integrated	Integrated	Integrated
DC Surge Protection	Type II	Type II	Type II
AC Surge Protection	Type II	Type II	Type II
Remote Shutdown	Integrated	Integrated	Integrated
General Data			
Operating Temperature Range (°C)	-35~+60	-35~+60	-35~+60
Storage Temperature (°C)	-40~+85	-40~+85	-40~+85
Relative Humidity	0~100%	0~100%	0~100%
Operating Environment	Outdoor	Outdoor	Outdoor
Max. Operating Altitude (m)	4000	4000	4000
Cooling Method	Natural Convection	Natural Convection	Natural Convection
User Interface	LED, WLAN+APP	LED, WLAN+APP	LED, WLAN+APP
Communication with BMS	RS485, CAN	RS485, CAN	RS485, CAN
Communication with Meter	RS485	RS485	RS485
Communication with Portal	LAN(4G optional)+ Bluetooth+WiFi	LAN(4G optional)+ Bluetooth+WiFi	LAN(4G optional)+ Bluetooth+WiFi
Weight (kg)	25	25	25
Dimension (WxHxD mm)	496*460*221	496*460*221	496*460*221
Noise Emission (dB)	<30	<45	<45

Topology	Non-isolated	Non-isolated	Non-isolated
Self-consumption at Night (W) ^{*7}	<15	<15	<15
Ingress Protection Rating	IP66	IP66	IP66
DC Connector	MC4 (4~6mm ²)	MC4 (4~6mm ²)	MC4 (4~6mm ²)
AC Connector	Feed-Through Terminal Blocks UW10	Feed-Through Terminal Blocks UW10	Feed-Through Terminal Blocks UW10
Environmental Category	4K4H	4K4H	4K4H
Pollution Degree	III	III	III
Overtoltage Category	DC II / AC III	DC II / AC III	DC II / AC III
Protective Class	I	I	I
The Decisive Voltage Class (DVC)	Battery: C PV: C AC: C Com: A	Battery: C PV: C AC: C Com: A	Battery: C PV: C AC: C Com: A
Mounting Method	Wall Mounted	Wall Mounted	Wall Mounted
Active Anti-islanding Method*8	AFDPF + AQDPF	AFDPF + AQDPF	AFDPF + AQDPF
Type of Electrical Supply System	Three phase Grid	Three phase Grid	Three phase Grid
Country of Manufacture	China	China	China
Certification ^{*9}			
Grid Standards	VDE-AR-N 4105, EN50549-1		
Safety Regulation	IEC62109-1&2		
EMC	EN61000-6-1, EN61000-6-2, EN61000-6-3, EN61000-6-4		

*1: Max. input power, not continuous for 1.6*normal power. Besides, in Australia, for most of the PV modules, the max. input power can reach 2*P_n, for example, the max. input power of GW6000-ET-20 can reach 12000W.

*2: For 1000V system, the maximum operating voltage is 950V.

*3: According to the local grid regulation.

*4: Output Voltage Range: phase voltage.

*5: When the three-unbalance function is activated, the Max. AC Current Output to the on-grid load can reach 13A, 17.4A, 21.7A, 21.7A and 21.7A respectively.

*6: Can be reached only if PV and battery power is enough.

*7: No Back-up Output.

*8: AFDPF: Active Frequency Drift with Positive Feedback, AQDPF: Active Q Drift with Positive Feedback.

*9: Not all certifications & standards are listed, check the official website for details.

12.2 Battery Parameters

Lynx home F

Technical parameters		LX F6.6-H	LX F9.8-H	LX F13.1-H	LX F16.4-H
Usable Energy(kWh) ^{*1}		6.55	9.83	13.1	16.38
Battery Module		LX F3.3-H: 38.4V 3.27kWh			
Number of Modules		2	3	4	5
Cell Type		LFP (LiFePO4)			
Cell Configuration		64S1P	96S1P	128S1P	160S1P
Nominal Voltage (V)		204.8	307.2	409.6	512
Operating Voltage Range (V)		182.4~230.4	273.6~345.6	364.8~460.8	456~576
Nominal Dis-/Charge Current (A) ^{*2}		25			
Nominal Power (kW) ^{*2}		5.12	7.68	10.24	12.80
Operating Temperature (°C)		Charge: 0 ~ +50; Discharge: -20 ~ +50			
Relative Humidity		0~95%			
Max. Operating Altitude (m)		2000			
Communication		CAN			
Weight (kg)		115	158	201	244
Dimensions (WxHxD mm)		600*625*380	600*780*380	600*935*380	600*1090*380
Enclosure Type		IP55			
Installation Location		Grounded			
Standard and Certification	Safety	IEC62619, IEC62040, CEC			
	EMC	CE, RCM			
	Transportation	UN38.3			
<p>*1: Test conditions, 100% DOD, 0.2°C charge & discharge at +25±2 °C for battery system at beginning life. System Usable Energy may vary with different Inverter.</p> <p>*2: Nominal Dis-/Charge Current and power derating will occur related to Temperature and SOC.</p>					

Lynx home F Plus+

Technical parameters		LX F6.6-H	LX F9.8-H	LX F13.1-H	LX F16.4-H
Usable Energy(kWh) ^{*1}		6.55	9.83	13.1	16.38
Battery Module		LX F3.3-H: 38.4V 3.27kWh			
Number of Modules		2	3	4	5
Cell Type		LFP (LiFePO4)			
Cell Configuration		64S1P	96S1P	128S1P	160S1P
Nominal Voltage (V)		204.8	307.2	409.6	512

Operating Voltage Range (V)	182.4~230.4	273.6~345.6	364.8~460.8	456~576
Nominal Dis-/Charge Current (A) ^{*2}	25			
Nominal Power (kW) ^{*2}	5.12	7.68	10.24	12.80
Short-Circuit Current	2.62kA@1.62ms			
Operating Temperature Range (°C)	Charge: 0 ~ +50; Discharge: -20 ~ +50			
Relative Humidity	0~95%			
Max. Operating Altitude (m)	2000			
Communication	CAN			
Weight (kg)	115	158	201	244
Dimensions (W×H×D mm)	600×610×380	600×765×380	600×920×380	600×1075×380
Ingress Protection Rating	IP55			
Storage Temperature (°C)	-20 ~ +45 (≤ One Month); 0 ~ +35 (≤ One Year)			
Mounting Method	Grounded			
Round-trip Efficiency	96.4%			
Cycle Life ^{*3}	≥ 3500 @1C/1C			
Standard and Certification	Safety	IEC62619, IEC 62040, VDE2510-50, CEC,CE		
	EMC	CE, RCM		
	Transportation	UN38.3		
<p>*1: Test conditions, 100% DOD, 0.2°C charge & discharge at +25±2 °C for battery system at beginning life. System Usable Energy may vary with different Inverter.</p> <p>*2: Nominal Dis-/Charge Current and power derating will occur related to Temperature and SOC.</p> <p>*3: Based on 2.5~3.65V voltage rang @25±2°C of Cell under 1C/1C test condition and 80% EOL.</p>				

Lynx home F G2

Technical parameters	LX F9.6-H-20	LX F12.8-H-20	LX F16.0-H-20	LX F19.2-H-20	LX F22.4-H-20	LX F25.6-H-20	LX F28.8-H-20
Usable Energy (kWh) ^{*1}	9.6	12.8	16.0	19.2	22.4	25.6	28.8
Battery Module	LX F3.2-20: 64V 3.2kWh						
Number of Modules	3	4	5	6	7	8	9
Cell Type	LFP (LiFePO4)						
Cell Configuration	(20S)3S 1P	(20S)4S 1P	(20S)5S 1P	(20S)6S 1P	(20S)7S 1P	(20S)8S 1P	(20S)9S 1P
Nominal Voltage (V)	192	256	320	384	448	512	576
Operating Voltage Range (V)	172.2~216.6	229.6~288.8	287~361	344.4~433.2	401.8~505.4	459.2~577.6	516.6~649.8
Nominal Dis-/Charge	35						

Current (A) ^{*2}							
Nominal Power (kW) ^{*2}	6.72	8.96	11.2	13.44	15.68	17.92	20.16
Operating Temperature Range (°C)	Charge: 0~+50; Discharge: -20~+50						
Relative Humidity	0 ~ 95%						
Max. Operating Altitude (m)	3000						
Communication	CAN						
Weight (kg)	120	154	188	222	256	290	324
Dimension (WxHxD mm)	600x715 x380	600x871 x380	600x102 7x380	600x118 3x380	600x133 9x380	600x149 5x380	600x165 1x380
Ingress Protection Rating	IP55						
Storage Temperature (°C)	-20~+45(≤One Month) ; 0~+35(≤One Year)						
Mounting Method	Grounded						
Round-trip Efficiency	94%						
Cycle Life ^{*3}	>4000						
Standard and Certification	Safety	IEC62619, IEC62040-1, IEC63056, VDE2510, CE, CEC					
	EMC	CE, RCM					
	Transportation	UN38.3					
<p>*1: Test conditions, 100% DOD, 0.2°C charge & discharge at +25±2 °C for battery system at beginning life. System Usable Energy may vary with different inverter.</p> <p>*2: Nominal Dis-/Charge Current and power derating will occur related to Temperature and SOC.</p> <ul style="list-style-type: none"> • When a single battery system is applied, the Nominal Dis-/Charge Current is 35A. • When two battery systems are applied, the Nominal Dis-/Charge Current is 70A. • When more than three battery systems are applied, the Nominal Dis-/Charge Current is 100A. <p>*3: Based on 2.5~3.65V voltage rang @25±2°C of Cell under 0.7C/1C test condition and 80% EOL.</p>							

Lynx home D

Technical parameters	LX D5.0-10
Usable energy (kWh) ^{*1}	5
Cell Type	LFP (LiFePO ₄)
Cell Configuration	16S1P
Nominal Voltage (V)	Charge: 435V; Discharge: 380V
Operating Voltage Range (V)	320~480V
Nominal Power (kW) ^{*2}	3
Peak Power (kW) ^{*2}	5KW, 10s
Operating Temperature Range (°C)	Charge: 0~+53; Discharge: -20~+53

Relative Humidity	0~95%	
Max. Operating Altitude (m)	4000	
Communication	CAN	
Weight (kg)	52	
Dimension (W×H×D mm)	700×380×170	
Ingress Protection Rating	IP66	
Storage Temperature (°C)	-20~0 (≤ One Months), 0~+35 (<One Year)	
Mounting Method	Floor stacked, Wall Mounted	
Standard and Certification	Safety	IEC62619、IEC60730、VDE2510-50、CE、CEC
	EMC	CE, RCM
	Transportation	UN38.3
*1: Test conditions, 100% DOD, 0.2C charge & discharge at +25±3 °C for battery system at beginning life. Usable energy may vary with different inverter.		
*2: Nominal Dis-/Charge Current and power derating will occur related to Temperature and SOC.		

12.3 Smart Meter Parameters

Technical parameters		GM3000	
Input	Grid	Three-phase	
	Voltage	Nominal Voltage-Line to N (Vac)	230
		Nominal Voltage-Line to Line (Vac)	400
		Voltage Range	0.88Un-1.1Un
		Nominal AC Grid Frequency (Hz)	50/60
	Current	Current Transformer Ratio	120A:40mA
		Number of Current Transformers	3
Communication		RS485	
Communication Distance (m)		1000	
User interface		3 LED, Reset button	
Accuracy	Voltage/Current	Class 1	
	Active Energy	Class 1	
	Reactive Energy	Class 2	
Power Consumption(W)		<3	
Mechanical	Dimensions (W×H×D mm)	36*85*66.5	
	Weight (g)	450	
	Mounting	Din rail	
Environment	Ingress Protection Rating	IP20	
	Operating Temperature Range (°C)	-25~60	
	Storage Temperature Range(°C)	-30~70	

	Relative Humidity (non-condensing)	0~95%
	Max. Operating Altitude (m)	2000

Technical parameters		GM330	
Input	Grid	Three-phase	
	Voltage	Nominal Voltage-Line to N (Vac)	230
		Nominal Voltage-Line to Line (Vac)	380/400
		Voltage Range	0.88Un-1.1Un
		Nominal AC Grid Frequency (Hz)	50/60
Current	Current Transformer Ratio	nA:50A	
Communication		RS485	
Communication Distance (m)		1000	
User interface		4 LED, Reset button	
Accuracy	Voltage/Current	Class 0.5	
	Active Energy	Class 0.5	
	Reactive Energy	Class 1	
Power Consumption(W)		<5	
Mechanical	Dimensions (W×H×D mm)	72*85*72	
	Weight (g)	240	
	Mounting	Din rail	
Environment	Ingress Protection Rating	IP20	
	Operating Temperature Range (°C)	-30~70	
	Storage Temperature Range(°C)	-30~70	
	Relative Humidity (non-condensing)	0~95%	
	Max. Operating Altitude (m)	3000	

12.4 Smart Dongle Parameters

Technical parameters		WiFi/LAN Kit-20
Input voltage (V)		5
Power Consumption (W)		≤3
Connection Interface		USB
Communication	Ethernet Interface	10M/100Mbps Self-adaption
	WLAN	IEEE 802.11 b/g/n @2.4 GHz
	Bluetooth	Bluetooth V4.2 BR/EDR Bluetooth LE Specification

Mechanical Parameters	Dimensions (W×H×D mm)	48.3*159.5*32.1
	Weight (g)	82
	Ingress Protection Rating	IP65
	Installation	Plug and Play
Operating Temperature Range (°C)		-30 - 60°C
Storage Temperature Range (°C)		-40 - 70°C
Relative Humidity		0-95%
Max. Operating Altitude (m)		4000

Technical parameters	Ezlink3000
General Data	
Connection Interface	USB
Ethernet Interface (optional)	10/100Mbps self-adaption, Communication distance ≤ 100m
Installation	Plug and Play
Indicator	LED Indicator
Dimensions (W×H×D mm)	48*153*32
Weight (g)	130
Ingress Protection Rating	IP65
Power Consumption (W)	< 2 (typical)
Operating Mode	STA
Wireless Parameter	
Bluetooth Communication	Bluetooth 5.1
WiFi Communication	802.11b/g/n (2.412G-2.484G)
Environment	
Operating Temperature Range (°C)	-30 - 60°C
Storage Temperature Range (°C)	-40 - 70°C
Relative Humidity	0-100% (non-condensing)
Max. Operating Altitude (m)	4000

Technical	4G Kit-CN-G20	4G Kit-CN-G21
-----------	---------------	---------------

parameters		
General Data		
Max. Number of Connected Devices	1	1
Connection Interface	USB	USB
Installation	Plug and Play	Plug and Play
Indicator	LED	LED
Dimensions (W×H×D mm)	48.3*95.5*32.1	48.3*95.5*32.1
SIM card size (mm)	15*12	15*12
Ingress Protection Rating	IP66	IP66
Weight (g)	87g	87g
Power Consumption (W)	<4	<4
Operating Temperature Range (°C)	-30~+65°C	-30~+65°C
Storage Temperature Range (°C)	-40~+70°C	-40~+70°C
Relative Humidity	0-100%	0-100%
Max. Operating Altitude (m)	4000	4000
Wireless Parameter		
LTE-FDD	B1/B3/B5/B8	B1/B3/B5/B8
LTE-TDD	B34/B39/B40/B41	B34/B39/B40/B41
GNSS positioning	/	Beidou, GPS

Technical parameters	4G Kit-CN	LS4G Kit-CN
General Data		
Max. Number of Connected Devices	1	

Connection Interface	USB
Installation	Plug and Play
Indicator	LED
Dimensions (W×H×D mm)	49*96*32
SIM card size (mm)	15*12
Ingress Protection Rating	IP65
Power Consumption (W)	<4
Operating Temperature Range (°C)	-30~60°C
Storage Temperature Range (°C)	-40~70°C
Relative Humidity	0-100% (non-condensing)
Max. Operating Altitude (m)	4000
Wireless Parameter	
LTE-FDD	B1/B3/B5/B8
LTE-TDD	B34/B38/B39/B40/B41
GNSS positioning	B3/B8

13 Appendix

13.1 FAQ

13.1.1 How to Perform Meter/CT Detection?

Meter/CT detection is used to auto-check if the Smart Meter and CT are connected in the right way and their working status.

Step 1 Tap **Home > Settings > Meter/CT Assisted Test** to set the function.

Step 2 Tap **Start Test** to start test. Check Test Result after test.

13.1.2 How to Upgrade Firmware Version

Check and upgrade the DSP version, ARM version, BMS version, AFCI version of the inverter, or firmware version of the communication module. Some devices do not support upgrading the firmware version through SolarGo app.

Method I:

If the Firmware Upgrade dialog box pops up once logging into the app, click Firmware Upgrade to directly go to the firmware information page.

When prompted by a red dot on the right of the Firmware Information, click to get the firmware update information.

During the upgrade process, ensure that the network is stable and the device remains connected to SolarGo, otherwise the upgrade may fail.

Step 1 Tap **Home > Settings > Firmware Upgrade** to check the firmware version. If the Firmware Upgrade dialog box pops up once logging into the app, click Firmware Upgrade to directly go to the firmware information page.

Step 2 (Optional) Tap **Check For Update** to check whether there is a latest version to be updated.

Step 3 Tap **Firmware Upgrade** as prompted to enter the firmware upgrade page.

Step 4 (Optional) Tap **Learn More** to check the firmware related information, such as **Current Version, New Version, Update Record**, etc.

Step 5 Tap **Upgrade** and follow the prompts to complete the upgrading.

Method II:

The automatic upgrade function is allowed only when a WiFi/LAN Kit-20 module is applied, and the module firmware version is V2.0.1 and above.

After enabling the auto-upgrade function, if there is any update and the device is connected to the network, the corresponding firmware version can be automatically upgraded.

Step 1 Tap **Home > Settings > Firmware Upgrade** to check the firmware version.

Step 2 Enable or disable the Automatic Upgrade based on actual needs.

13.2 Acronyms and Abbreviations

U_{batt}	Battery Voltage Range
$U_{batt,r}$	Nominal Battery Voltage
$I_{batt,max (C/D)}$	Max. Continuous Charging Current Max. Continuous Discharging Current
$E_{C,R}$	Rated Energy
U_{DCmax}	Max.Input Voltage
U_{MPP}	MPPT Operating Voltage Range

$I_{DC,max}$	Max. Input Current per MPPT
$I_{SC\ PV}$	Max. Short Circuit Current per MPPT
$P_{AC,r}$	Nominal Output Power
S_r (to grid)	Nominal Apparent Power Output to Utility Grid
S_{max} (to grid)	Max. Apparent Power Output to Utility Grid
S_r (from grid)	Nominal Apparent Power from Utility Grid
S_{max} (from grid)	Max. Apparent Power from Utility Grid
$U_{AC,r}$	Nominal Output Voltage
$f_{AC,r}$	Nominal AC Grid Frequency
$I_{AC,max}$ (to grid)	Max. AC Current Output to Utility Grid
$I_{AC,max}$ (from grid)	Max. AC Current From Utility Grid
P.F.	Power Factor
S_r	Back-up Nominal apparent power
S_{max}	Max. Output Apparent Power (VA) Max. Output Apparent Power without Grid
$I_{AC,max}$	Max. Output Current
$U_{AC,r}$	Nominal Output Voltage
$f_{AC,r}$	Nominal Output Frequency
$T_{operating}$	Operating Temperature Range
$I_{DC,max}$	Max. Input Current
U_{DC}	Input Voltage
$U_{DC,r}$	DC Power Supply
U_{AC}	Power Supply/AC Power Supply
$U_{AC,r}$	Power Supply/Input Voltage Range
$T_{operating}$	Operating Temperature Range
P_{max}	Max Output Power
P_{RF}	TX Power
P_D	Power Consumption
$P_{AC,r}$	Power Consumption
F (Hz)	Frequency
$I_{SC\ PV}$	Max. Input Short Circuit Current
$U_{dcmin}-U_{dcmax}$	Range of input Operating Voltage
$U_{AC,rang}$ (L-N)	Power Supply Input Voltage
$U_{sys,max}$	Max System Voltage
$H_{altitude,max}$	Max. Operating Altitude
PF	Power Factor
THDi	Total Harmonic Distortion of Current
THDv	Total Harmonic Distortion of Voltage
C&I	Commercial & Industrial

SEMS	Smart Energy Management System
MPPT	Maximum Power Point Tracking
PID	Potential-Induced Degradation
Voc	Open-Circuit Voltage
Anti PID	Anti-PID
PID Recovery	PID Recovery
PLC	Power-line Communication
Modbus TCP/IP	Modbus Transmission Control / Internet Protocol
Modbus RTU	Modbus Remote Terminal Unit
SCR	Short-Circuit Ratio
UPS	Uninterruptible Power Supply
ECO mode	Economical Mode
TOU	Time of Use
ESS	Energy Storage System
PCS	Power Conversion System
SPD	Surge Protection Device
DRED	Demand Response Enabling Device
RCR	Ripple Control Receiver
AFCI	AFCI
GFCI	Ground Fault Circuit Interrupter
RCMU	Residual Current Monitoring Unit
FRT	Fault Ride Through
HVRT	High Voltage Ride Through
LVRT	Low Voltage Ride Through
EMS	Energy Management System
BMS	Battery Management System
BMU	Battery Measure Unit
BCU	Battery Control Unit
SOC	State of Charge
SOH	State of Health
SOE	State Of Energy
SOP	State Of Power
SOF	State Of Function
SOS	State Of Safety
DOD	Depth of discharge

13.3 Term Explanation

Overvoltage category definition

Category I: Applies to equipment connected to a circuit where measures have been taken to reduce transient

overvoltage to a low level.

Category II: Applies to equipment not permanently connected to the installation. Examples are appliances, portables tools and other plug-connected equipment.

Category III: Applies to a fixed equipment downstream, including the main distribution board. Examples are switchgear and other equipment in an industrial installation.

Category IV: Applies to equipment permanently connected at the origin of an installation (upstream of the main distribution board). Examples are electricity meters, primary over-current protection equipment and other equipment connected directly to outdoor open lines.

Moisture location category definition

Parameters	Level		
	3K3	4K2	4K4H
Moisture Parameters	0 - +40°C	-33 - +40°C	-33 - +40°C
Temperature Range	5% - 85%	15% - 100%	4% - 100%

Environment category definition

Outdoor: Ambient Temperature: -25~+60°C, applied to Pollution Degree 3 environment.

Indoor Unconditioned: Ambient Temperature: -25~+40°C, applied to Pollution Degree 3 environment.

Indoor conditioned: Ambient Temperature: 0~+40°C, applied to Pollution Degree 2 environment. Outdoor: Ambient Temperature: 0~+40°C, applied to Pollution Degree 2 environment.

Pollution degree definition

Pollution Degree I: No pollution or only dry, non-conductive pollution occurs. The pollution has no influence.

Pollution Degree II: Normally only non-conductive pollution occurs. Occasionally, however, a temporary conductivity caused by condensation must be expected.

Pollution Degree III: Conductive pollution occurs, or dry, non-conductive pollution occurs, which becomes conductive due to condensation, which is expected.

Pollution Degree IV: Persistent conductive pollution occurs, for example, the pollution caused by conductive dust, rain or snow.

13.4 Meaning of Battery SN Code



Bits 11-14 of the product SN code are the production time code.

The above picture has a production date of 2023-08-08.

- The 11th and 12th digits are the last two digits of the year of production, e.g., 2023 is represented by 23;
- The 13th digit is the month of production, e.g. August is denoted by 8;

The details are as follows:

Month	January~September	October	November	December
-------	-------------------	---------	----------	----------

Month Code	1~9	A	B	C
------------	-----	---	---	---

- The 14th digit is the date of manufacture, e.g., 8th indicated by 8;

Priority is given to the use of numbers, e.g. 1~9 for days 1~9, A for day 10 and so on. The letters I and O are not used to avoid confusion. The details are as follows:

Production Date	1st	2nd	3rd	4th	5th	6th	7th	8th	9th
Code	1	2	3	4	5	6	7	8	9

Production Date	10th	11th	12th	13th	14th	15th	16th	17th	18th	19th	20th
Code	A	B	C	D	E	F	G	H	J	K	L

Production Date	21st	22nd	23rd	24th	25th	26th	27th	28th	29th	30th	31st
Code	M	N	P	Q	R	S	T	U	V	W	X