

V1.5 2026-02-12

Residential All-In-One Energy Storage System

ESA 3-10kW

GW5.1-BAT-D-G20

GW8.3-BAT-D-G20

GW5.1-BAT-D-G21

GW8.3-BAT-D-G21

Solutions Manual

GOODWE

Copyright Statement

Copyright Statement

All rights reserved©GoodWe Technologies Co., Ltd. 2026All rights reserved.

Without the authorization of GoodWe Technologies Co., Ltd., no part of this manual may be reproduced, disseminated, or uploaded to public networks or any third-party platforms in any form.

Trademark Licensing

GOODWE and other terms used in this manualGOODWEThe trademark is owned by GoodWe Technologies Co., Ltd. All other trademarks or registered trademarks mentioned in this manual belong to their respective owners.

NOTICE

Due to product version upgrades or other reasons, the content of the document will be updated periodically. Unless otherwise agreed, the content of the document cannot replace the Safety Precautions in the product label. All descriptions in the document are provided for guidance only.

About This Manual

Overview

The energy storage system consists of inverter, battery system, and smart meter. This manual describes the product information, installation, electrical connection, commissioning, troubleshooting and maintenance of the system. Read through this manual before installing and operating the products to understand product safety information and familiarize yourself with functions and features of the product. This manual is subject to update without notice. For more product details and latest documents, visit <https://en.goodwe.com/>.

Applicable Model

The energy storage system includes the following products:

Product Type	Product Information	Description
Inverter	GW3K-EHA-G20 GW3.6K-EHA-G20 GW5K-EHA-G20 GW6K-EHA-G20 GW8K-EHA-G20 GW9.999K-EHA-G20 GW10K-EHA-G20 GW3K-BHA-G20 GW3.6K-BHA-G20 GW5K-BHA-G20 GW6K-BHA-G20 GW8K-BHA-G20 GW9.999K-BHA-G20 GW10K-BHA-G20	Nominal output power: 3kW-10kW
	GW5.1-BAT-D-G20	Rated energy 5.12kWh

Product Type	Product Information	Description
Battery system	GW5.1-BAT-D-G21	Rated energy 8.32kWh
	GW8.3-BAT-D-G20	
	GW8.3-BAT-D-G21	
Meter	GMK110	Monitoring module in the energy storage system, capable of detecting operating voltage, current, and other information.
	GM330	
smart dongle	WiFi/LAN Kit-20	Can upload system operation information to the monitoring platform via WiFi or LAN signals.
	4G Kit-CN-G20 (China only)	Can upload system operation information to the monitoring platform via 4G.

Symbol Definition

DANGER
Indicates a high-level hazard that, if not avoided, will result in death or serious injury.
 WARNING
Indicates a medium-level hazard that, if not avoided, could result in death or serious injury.
CAUTION
Indicates a low-level hazard that, if not avoided, could result in minor or moderate injury.
NOTICE
Highlights key information and supplements the texts. Or some skills and methods to solve product-related problems to save time.

Table of Contents

1 Safety Precautions	12
1.1 General Safety	12
1.2 personnel requirements	12
1.3 System Safety	13
1.3.1 PV String Safety	14
1.3.2 Inverter Safety	15
1.3.3 Battery Safety	16
1.3.4 Smart Meter Safety	19
1.4 Safety Symbols and Certification Marks	19
1.5 EU Declaration of Conformity	21
1.5.1 Equipment with Wireless Communication Modules	21
1.5.2 No Equipment with Wireless Communication Modules (except Battery)	21
1.5.3 Battery	22
2 System Introduction	23
2.1 System Overview	23
2.2 Product Overview	38
2.2.1 Residential All-in-One System	38
2.2.2 Smart Meter	44
2.2.3 smart dongle	44
2.3 Supported Grid Types	45
2.4 System Working Mode	46

2.5 Features	56
3 Check and Storage	59
3.1 Check Before Receiving	59
3.2 deliverables	59
3.2.1 Inverter Deliverables	59
3.2.2 Batteries Deliverables	61
3.2.2.1 Cluster Expansion Base deliverables	62
3.2.3 Smart Meter Deliverables	64
3.2.3.1 Smart Meter Deliverables(GMK110)	64
3.2.3.2 Smart Meter Deliverables(GM330)	65
3.3 Storage	65
4 Installation	68
4.1 Installation Requirements	68
4.1.1 Installation Environment Requirements	68
4.1.2 Installation Space Requirements	69
4.1.3 Tool Requirements	70
4.2 Equipment Handling	72
4.3 Installation equipment	73
4.4 Installing the Smart Meter	78
5 System Wirings	80
5.1 System Wiring Electrical Block Diagram	81
5.2 Detailed System Wiring Diagram	84

5.2.1 Detailed System Wiring Diagram for Single Inverter.....	86
5.2.2 Detailed System Wiring Diagram for Parallel System.....	93
5.3 Preparing Materials.....	97
5.3.1 Preparing Breakers.....	98
5.3.2 Preparing Cables.....	100
5.4 Connecting the PE cable.....	103
5.5 Connecting the PV Cable.....	104
5.6 Connecting the Battery Cable.....	107
5.7 Connecting the AC Cable.....	108
5.8 Connecting the Meter Cable.....	110
5.9 Connecting the Inverter Communication Cable.....	114
6 System Commissioning.....	119
6.1 Check Before Power ON.....	119
6.2 Power ON.....	119
6.3 Installation Protective coverP.....	122
6.4 Indicators.....	122
6.4.1 Inverter Indicators.....	122
6.4.2 Battery Indicators.....	125
6.4.3 Smart Meter Indicator.....	126
6.4.4 Smart Dongle Indicator.....	127
7 System Quick Configuration.....	130
7.1 Downloading the App.....	130

7.1.1	Download the SolarGo App	130
7.1.2	Download SEMS+ APP	130
7.2	Connect hybrid inverter (Bluetooth)	131
7.3	Connection smart dongle	132
7.4	Set communication parameters	133
7.4.1	Configure privacy and security parameters	134
7.4.2	Set WLAN/LAN parameters	137
7.4.3	Set RS485 communication parameters	139
7.5	System Quick Settings	139
7.5.1	System Quick Settings (Type 1)	141
7.6	Power Plant Creation	145
8	System Commissioning	147
8.1	Commissioning Method Overview	147
8.2	SolarGo APP	147
8.2.1	App Introduction	147
8.2.1.1	Download the Installation App	147
8.2.1.2	Connection method	148
8.2.1.3	Login Interface Introduction	149
8.2.2	Connect hybrid inverter (Bluetooth)	150
8.2.3	Connection smart dongle	152
8.2.4	hybrid inverter interface introduction	153
8.2.5	Set communication parameters	155

8.2.5.1 Configure privacy and security parameters	155
8.2.5.2 Configure WLAN/LAN parameters	158
8.2.5.3 Set RS485 communication parameters	160
8.2.6 Configure RS485 parallel system	160
8.2.7 System Quick Settings	161
8.2.7.1 System Quick Settings (Type 1)	163
8.2.8 Setting the Basic Information	167
8.2.8.1 Set up lightning protection alarm function	168
8.2.8.2 Set backup power parameters	168
8.2.8.3 Enable shadow scan function	170
8.2.8.4 Configure Power scheduling parameters	170
8.2.9 Setting Advanced Parameters	173
8.2.9.1 Configure DRED/Remote Shutdown/RCR/EnWG 14a functions	173
8.2.9.2 Set the BACK-UP N and PE relay switch	174
8.2.9.3 Set Export power limit parameters	175
8.2.9.3.1 Set Export power limit parameters (General)	175
8.2.9.3.2 Set Export power limit parameters (Australia)	176
8.2.9.4 Enable AFCI Detection function	178
8.2.9.5 Enable Battery function	178
8.2.9.5.1 Set lithium Battery parameters	178
8.2.9.6 Configure PVAccess Mode	181
8.2.10 Set custom safety parameters	183

8.2.10.1 Set reactive power curve	183
8.2.10.2 Set active power curve	188
8.2.10.3 Set Grid Protection Parameters	194
8.2.10.4 Configure Utility grid connection parameters	195
8.2.10.5 Set voltage fault crossing parameters	197
8.2.10.6 Set Frequencyfault ride-through parameters	198
8.2.11 Export parameters	199
8.2.11.1 Export safety parameters	199
8.2.11.2 Export log parameters	200
8.2.12 Set meter parameters	201
8.2.12.1 Bind/Unbind Meter	201
8.2.12.2 Meter/CT Auxiliary Detection	202
8.2.13 Set generator/load control parameters	203
8.2.13.1 Set load control parameters	203
8.2.13.2 Set generator parameters	205
8.2.13.3 Set microgrid parameters	208
8.2.14 Equipment maintenance	210
8.2.14.1 View Firmware Information/Firmware Upgrade	210
8.2.14.1.1 Conventional Upgrade Firmware	211
8.2.14.1.2 One-key Upgrade Firmware	212
8.2.14.1.3 automatic Upgrade Firmware	213
8.2.14.1.4 View firmware information	214

8.2.14.2 Change login password	215
9 Perform Power Plant Monitoring via Xiaogu Cloud Window+.	217
9.1 Download the Installation Xiaogu Cloud Window+ App	217
10 Power Plant Monitoring via SEMS+	219
11 Maintenance	220
11.1 Power OFF the System	220
11.2 Removing the Equipment	221
11.3 Disposing of the Equipment	222
11.4 Routine Maintenance	222
11.5 fault	223
11.5.1 Viewing Fault/Alarms Information	223
11.5.2 Fault Information and Troubleshooting	224
11.5.2.1 Inverter fault	226
11.5.2.2 Batteryfault	295
11.5.3 Clear post-processing	313
11.5.3.1 Clear AFCI Failure WARNING	313
12 technical parameter	315
12.1 Inverter Parameters	315
12.2 Battery Technical Data	351
12.3 Smart Meter Technical Data	353
12.3.1 GMK110	353
12.3.2 GM330	354

12.4 Smart Dongle Technical Data	355
12.4.1 WiFi/LAN Kit-20	355
12.4.2 4G Kit-CN-G20	356
13 Appendix	358
13.1 FAQ	358
13.1.1 How to perform Meter/CT Auxiliary Detection?	358
13.1.2 How to Upgrade the Device Version	358
13.2 Abbreviations	359
13.3 Explanation of Terms	362
13.4 Battery SN code meaning	363
13.5 National Safety Regulations	364
13.6 Australia Safety Regulations	368

1 Safety Precautions

Please strictly follow these safety instructions in the user manual during the operation.

WARNING

The products are designed and tested strictly to comply with related safety rules. Follow all the safety instructions and cautions before any operations. Improper operation might cause personal injury or property damage as the products are electrical equipment.

1.1 General Safety

NOTICE

- The information in this user manual is subject to change due to product updates or other reasons. This manual cannot replace the product safety labels unless otherwise specified. All descriptions in the manual are for guidance only.
- Before installations, read through the user manual to learn about the product and the precautions.
- All operations should be performed by trained and knowledgeable technicians who are familiar with local standards and safety regulations.
- Use insulating tools and wear personal protective equipment(PPE) when operating the equipment to ensure personal safety. Wear anti-static gloves, wrist strips, and cloths when touching electronic devices to protect the equipment from damage.
- Unauthorized dismantling or modification may damage the equipment, and the damage is not covered under the warranty.
- Strictly follow the installation, operation, and configuration instructions in this manual or the user manual. The manufacturer shall not be liable for equipment damage or personal injury if you do not follow the instructions. For more warranty details, please visit <https://www.goodwe.com/warrantyrelated.html>.

1.2 personnel requirements

NOTICE

To ensure the safety, compliance, and efficiency throughout the transportation, installation, wiring, operation, and maintenance of the equipment, the work must be carried out by professionals or qualified personnel.

1. Professionals or qualified personnel include:
 - Personnel who have mastered the equipment's working principles, system structure, and knowledge of relevant risks and hazards, and have received professional operation training or possess rich practical experience.
 - Personnel who have received relevant technical and safety training, have certain operational experience, can be aware of potential dangers that specific operations may pose to themselves, and are able to take protective measures to minimize risks to themselves and others.
 - Qualified electrical technicians who meet the regulatory requirements of the country/region where they are located.
 - Personnel who hold a degree in electrical engineering/an advanced diploma in an electrical discipline or equivalent qualification/a professional qualification in the electrical field, and have at least 2/3/4 years of experience in testing and supervising in accordance with electrical equipment safety standards.
2. Personnel engaged in special tasks such as electrical operations, working at heights, and operation of special equipment must hold valid qualification certificates as required by the location of the equipment.
3. Operation of medium-voltage equipment must be performed by certified high-voltage electricians.
4. Replacement of the equipment and its components is only permitted to be carried out by authorized personnel.

1.3 System Safety

DANGER

- Disconnect the upstream switches to power off the equipment before any electrical connections. Do not work with power on. Otherwise, an electric shock may occur.
- Install a breaker at the voltage input side of the equipment to prevent personal injury or equipment damage caused by energized electrical work.
- All operations such as transportation, storage, installation, use and maintenance shall comply with applicable laws, regulations, standards and specifications.
- Perform electrical connections in compliance with local laws, regulations, standards and specifications, including cables and component specifications.
- Use the connectors included in the package to connect cables. The manufacturer shall not be liable for the equipment damage if connectors of other models are used.
- Ensure all cables are connected correctly, tightly, and securely. Inappropriate wiring may cause poor connection and damage the equipment.
- The PE cables must be connected and secured properly.
- To protect the equipment and components from damage during transportation, ensure that the transportation personnel are professionally trained. All operations during the transportation have to be recorded. The equipment shall be kept in balance to avoid falling down.
- The equipment is heavy. Please equip the corresponding personnel according to its weight, so that the equipment does not exceed the maximum weight that the personnel can carry to avoid personnel injuries.
- Keep the equipment stable to avoid dumping, which can result in equipment damage and personal injuries.

 **WARNING**

- Do not apply mechanical load to terminals, otherwise the terminals may be damaged.
- If the cable bears too much tension, the connection may be poor. Reserve a certain length of the cable before connecting it to corresponding ports.
- Tie the cables of the same type together, and place cables of different types at least 30mm apart. Do not place the cables entangled or crossed.
- Place the cables at least 30mm away from the heating components or heat sources, otherwise the insulation layer of the cables may be aging or broken due to high temperature.

1.3.1 PV String Safety

WARNING

- Ensure the PV module frames and the bracket system are securely grounded.
- Ensure the DC cables are connected tightly, securely and correctly. Inappropriate wiring may cause poor contacts or high impedances, and damage the inverter.
- Measure the positive and negative terminals of the DC cable using a multimeter to avoid reverse polarity connection. Also, the voltage should be within the permissible range.
- Measure the DC cable using the multimeter to avoid reverse polarity connection. Also, the voltage should be under the max DC input voltage. The manufacturer shall not be liable for the damage caused by reverse connection and extremely high voltage.
- The PV strings cannot be grounded. Ensure the minimum insulation resistance of PV string to the ground meets the minimum insulation resistance requirements before connecting the PV string to the inverter ($R = \text{maximum input voltage (V)} / 30\text{mA}$).
- Do not connect the same PV string to multiple inverters at the same time. Otherwise, the inverters may be damaged.
- PV modules used with inverters must comply with IEC 61730 Class A standard.

1.3.2 Inverter Safety

WARNING

- The voltage and frequency at the grid connecting point of the grid should meet the grid connecting requirements of the inverter.
- Additional protective devices like circuit breakers or fuses are recommended on the AC side. Specification of the protective device should be at least 1.25 times the maximum AC output current of the inverter.
- The arc fault alarms will be cleared automatically if the alarms are triggered less than 5 times in 24 hours. The inverter will shutdown for protection after the 5th electric arc fault. The inverter can operate normally after the fault is solved.
- BACK-UP is not recommended to use if the PV system is not configured with batteries. Otherwise, there may be a risk of system power outage.

1.3.3 Battery Safety



- Keep Power Off before any operations to avoid danger of electric shock. Strictly follow all safety precautions outlined in this manual and safety labels on the equipment during the operation.
- Do not disassemble, modify, or replace any part of the battery without official authorization from the manufacturer. Otherwise, it will cause electrical shock or damages to the equipment, which shall not be borne by the manufacturer.
- Do not hit, pull, drag, squeeze or step on the equipment or put the battery into fire. Otherwise, the battery may explode.
- Do not place the battery in a high temperature environment. Make sure that there is no direct sunlight and no heat source near the battery. When the ambient temperature exceeds 60 °C, it will cause fire.
- Do not use the battery if it is defective, broken, or damaged. Damaged battery may leak electrolyte.
- Do not move the battery system while it is working. Contact after-sales service if the battery shall be replaced or added.
- A short circuit in the battery may cause personal injury. The instantaneous high current caused by a short circuit can release a large amount of energy and may cause a fire.
- To protect the equipment and components from damage during transportation, ensure that the transportation personnel are professionally trained. All operations during the transportation have to be recorded. The equipment shall be kept in balance to avoid falling down.
- Battery The equipment is heavy. Please equip the corresponding personnel according to its weight, so that the equipment does not exceed the maximum weight that the personnel can carry to avoid personnel injuries.

 WARNING

- Factors such as temperature, humidity, weather conditions, etc. may limit the battery's current and affect its load-carrying ability.
- Contact after-sale service immediately if the battery is not able to be started. Otherwise, the battery might be damaged permanently.
- Inspect and maintain the battery regularly according to the maintenance requirements of the battery.
- Ensure that the battery system is not damaged during transportation and storage. Keep the equipment stable to avoid dumping, which can result in equipment damage and personal injuries.

Emergency Measures

- **Battery Electrolyte Leakage**

If the battery module leaks electrolyte, avoid contact with the leaking liquid or gas. The electrolyte is corrosive. It will cause skin irritation or chemical burn to the operator. Anyone contact the leaked substance accidentally has to act/respond as following:

- Breath in the leaked substance: Evacuate from the polluted area, and seek immediate medical assistance.
 - Eye contact: Rinse your eyes for at least 15 minutes with clean water and seek immediate medical assistance.
 - Skin contact: Thoroughly wash the touch area with soap and clean water, and seek immediate medical assistance.
 - Ingestion: Induce vomiting, and seek immediate medical assistance.
- **Fire**
 - The battery may burn when the ambient temperature exceeds 150°C. Poisonous and hazardous gas may be released if the battery is on fire.
 - In the event of a fire, please make sure that the carbon dioxide extinguisher or water extinguishing device is nearby.
 - The fire cannot be put out by ABC dry powder extinguisher. Firefighters are required to wear full protective clothing and self-contained breathing apparatus.
 - **Battery triggers fire protection**

For batteries with fire protection functions, perform the following operations after the fire protection function is triggered:

 - Immediately cut off the main power switch to ensure that no current passes through the battery system.
 - Conduct a preliminary inspection of the appearance of the battery to determine

if there is any damage, deformation, leakage, or odor. Check the battery casing, connectors, and cables.

- Use temperature sensors to detect the temperature of the battery and its environment, ensuring there is no risk of overheating.
- Isolate and label damaged batteries, and handle them properly in accordance with local regulations.

1.3.4 Smart Meter Safety



WARNING





If the voltage of the grid fluctuates and exceed 265V, the meter may be damage by long-term overvoltage operation. It is recommended to add a fuse with a rated current of 0.5A on the voltage input side of the meter to protect it.





1.4 Safety Symbols and Certification Marks

DANGER

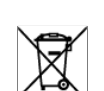
- All labels and warning marks should be visible after the installation. Do not cover, scrawl, or damage any label on the equipment.
- The following descriptions are for reference only. Please refer to the actual labeling of the equipment.

No.	Symbol	Descriptions
1		Potential risks exist. Wear proper PPE before any operations.
2		HIGH VOLTAGE HAZARD. High voltage exists. Disconnect all incoming power and turn off the product before working on it.
3		High-temperature hazard. Do not touch the product under operation to avoid being burnt.

No.	Symbol	Descriptions
4		Operate the equipment properly to avoid explosion.
5		Batteries contain flammable materials, beware of fire.
6		The equipment contains corrosive electrolytes. In case of a leak in the equipment, avoid contacting the leaked liquid or gas.
7		Delayed discharge. Wait 5 minutes after power off until the components are completely discharged.
8		Install the equipment away from fire sources.
9		Keep away from children.
10		Do not pour with water.
11		Read through the user manual before any operations.
12		Wear PPE during installation, operation and maintaining.
13		Do not dispose of the System as household waste. Deal with it in compliance with local laws and regulations, or send it back to the manufacturer.

No.	Symbol	Descriptions
14		Grounding point.
15		Recycle regeneration mark.
16		CE Mark.
17		TUV mark.
18		RCM mark.

1.5 EU Declaration of Conformity

1.5.1 Equipment with Wireless Communication Modules

The equipment with wireless communication modules sold in the European market meets the requirements of the following directives:

- Radio Equipment Directive 2014/53/EU (RED)
- Restrictions of Hazardous Substances Directive 2011/65/EU and (EU) 2015/863 (RoHS)
- Waste Electrical and Electronic Equipment 2012/19/EU
- Registration, Evaluation, Authorization and Restriction of Chemicals (EC) No 1907/2006 (REACH)

1.5.2 Equipment without Wireless Communication Modules (Except Battery)

The equipment without wireless communication modules sold in the European market meets the requirements of the following directives:

- Electromagnetic compatibility Directive 2014/30/EU (EMC)
- Electrical Apparatus Low Voltage Directive 2014/35/EU (LVD)
- Restrictions of Hazardous Substances Directive 2011/65/EU and (EU) 2015/863 (RoHS)
- Waste Electrical and Electronic Equipment 2012/19/EU
- Registration, Evaluation, Authorization and Restriction of Chemicals (EC) No 1907/2006 (REACH)

1.5.3 Battery

The batteries sold in the European market meets the requirements of the following directives:

- Electromagnetic compatibility Directive 2014/30/EU (EMC)
- Electrical Apparatus Low Voltage Directive 2014/35/EU (LVD)
- Battery Directive 2006/66/EC and Amending Directive 2013/56/EU
- Waste Electrical and Electronic Equipment 2012/19/EU
- Registration, Evaluation, Authorization and Restriction of Chemicals (EC) No 1907/2006 (REACH)

You can download the EU Declaration of Conformity from our [official website](#).

2 System Introduction

2.1 System Overview

The integrated residential storage solution combines Inverter, Battery, Smart Meter, and smart dongle to convert solar energy into electricity within a photovoltaic system, meeting household power demands. Energy IoT devices in the system monitor overall power conditions and manage electrical loads, enabling intelligent control of electricity for direct use, storage in Battery, or export to Utility grid.

WARNING

- energy storage system is not suitable for connecting devices that rely on stable power supply, such as life-sustaining medical equipment, etc. Please ensure the system POWER OFF when, Must not cause personal injury.
- When the residential storage integrated unit operates under high temperature or BMS current-limiting conditions, it may result in restricted Battery charge Power, leading to excessive system voltage and triggering overvoltage Protection.
- In Microgrid Scenario, the PV open-circuit voltage of the residential storage all-in-one system is recommended to be <500V to prevent excessive system voltage under harsh operating conditions, which could trigger overvoltage Protection.
- In Microgrid Scenario, ensure that the over-frequency Derating point of grid-tied PV inverter matches that of the integrated residential energy storage system.
- grid-tied PV inverter If output Power limitation is required, please connect a separate meter or CT (Current Transformer) device.
- Please ensure the over-frequency Derating curve of grid-tied PV inverter is configured according to the following settings:
 - end power is set to 0% P_n
 - Response delay time setting is 0, Hysteresis Function enable is off.
- In a fully off-grid Inverter system, if the Battery experiences prolonged low-light or rainy conditions without timely Charge replenishment, it may lead to excessive Discharge, resulting in performance degradation or damage to the Battery. To ensure long-term stable operation of the system, complete discharge of the Battery should be avoided. The following measures are recommended:
 1. During off-grid operation, set the minimum SOC threshold. It is recommended

to configure the off-grid SOC lower limit to 30%.

2. When the SOC approaches the Protection threshold, the system will automatically enter load-limiting or Protection mode.
 3. If there is insufficient sunlight for several consecutive days and the Battery SOC is too low, external energy sources (such as a generator or Utility grid auxiliary Charge) should be promptly used to replenish the Battery.
 4. Regularly check the Battery status to ensure it remains within safe operating limits.
 5. It is recommended to perform a full charge and discharge cycle every six months to calibrate the SOC accuracy.
- Due to product version upgrades or other reasons, the document content will be updated periodically. The matching relationship between Inverter and IoT products can be referenced as follows:https://en.goodwe.com/Ftp/EN/Downloads/User%20Manual/GW_Compatibility-list-of-GoodWe-inverters-and-IoT-products-EN.pdf
 - For detailed networking and wiring schemes of each scenario, please refer to:[5.2.Detailed System Wiring Diagram\(Page 84\)](#).

energy storage system can power the following loads normally when operating in off-grid mode:

Off-grid load capacity description	
Inverter model	ESA 3-10kW
Single motor load Rated Power (kVA)	0.3*Pn
Total motor load Rated Power (kVA)	0.3*Pn
Pure capacitive load (kVA)	0.33*Pn
<p>Note:</p> <ul style="list-style-type: none"> • Rated power: Inverter Nominal output power. • For 2 or more units in parallel operation, the allowable total motor load Rated Power = single motor load Rated Power × number of parallel units × 80%. 	

General scenario

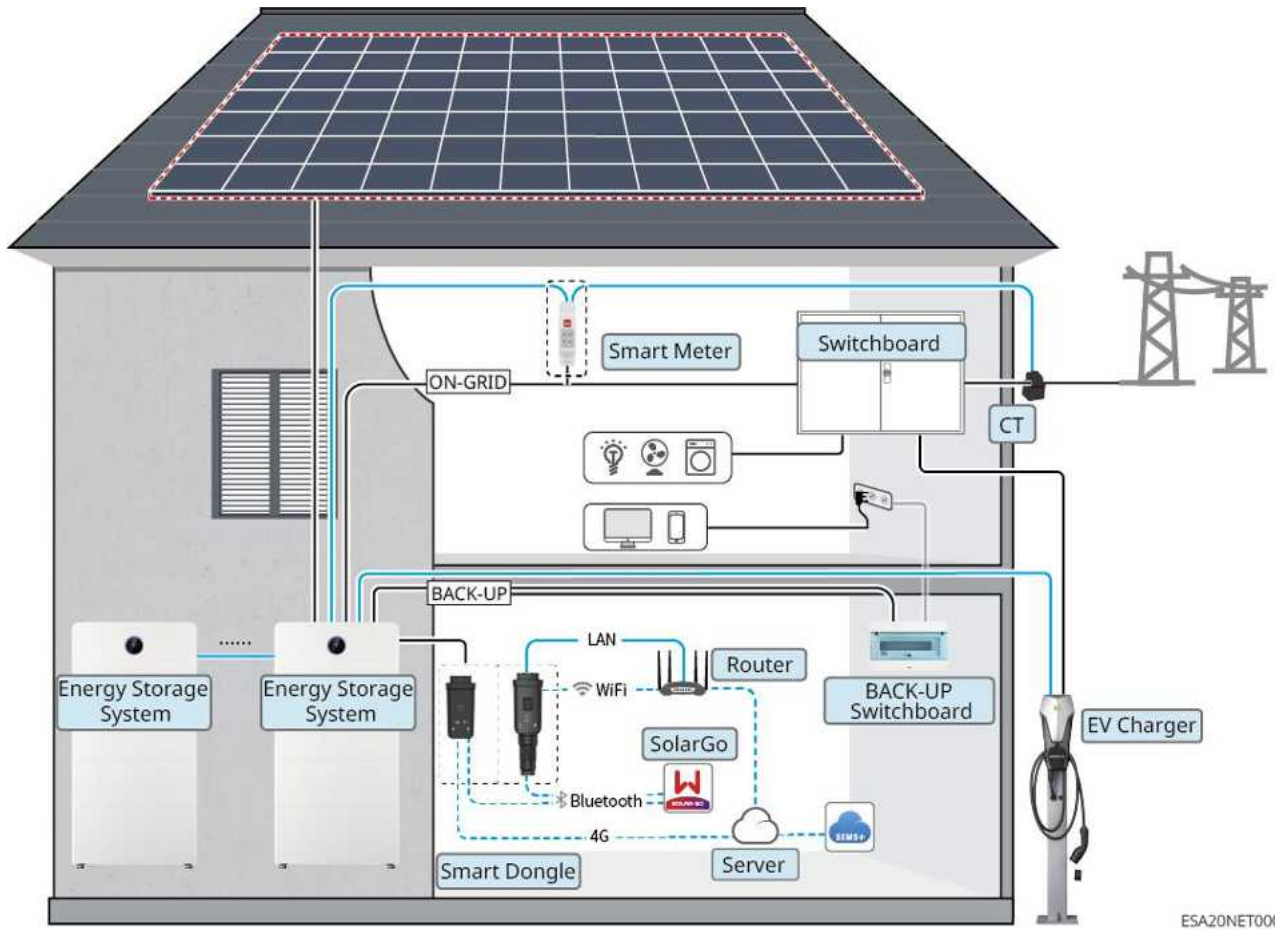

ESA20NET0001

Equipment Type	model	Description
hybrid inverter	GW3K-EHA-G20	
	GW3.6K-EHA-G20	
	GW5K-EHA-G20	
	GW6K-EHA-G20	
	GW8K-EHA-G20	
	GW9.999K-EHA-G20	
	GW10K-EHA-G20	
	GW3K-BHA-G20	

Equipment Type	model	Description
	GW3.6K-BHA-G20	<ul style="list-style-type: none"> • Compatible with GoodWe AC Charge charging pile. • Only in standalone scenarios, support for Diesel Generator Control and generator supply to Battery charge is available. • The system supports a maximum of 6 Inverter units to form a parallel system, allowing mixed parallel operation of Inverter On/Off-grid with different Power segments. • In a parallel system, if the GW3K/3.6K/5K/6K models are mixed with the GW8K/9.999K/10K models, please set the GW8K/9.999K/10K models as Master inverter. • To connect a generator or Parallel Networking, use the GMK110 or GM330 Smart Meter. If the number of parallel units exceeds two Inverter, use the GM330 Smart Meter. • In a parallel system, each Inverter requires a Installation WiFi/LAN Kit-20, with the software version requirement being V2.5 or higher. • The system networking must meet the following version requirements: <ul style="list-style-type: none"> ◦ Inverter ARM software version is 02.99 and above. ◦ Inverter DSP software version is 03.3010 and above. ◦ SolarGo software version is 6.9.0 or above.
	GW5K-BHA-G20	
	GW6K-BHA-G20	
	GW8K-BHA-G20	
	GW9.999K-BHA-G20	
	GW10K-BHA-G20	
Battery system	GW5.1-BAT-D-G20	
	GW5.1-BAT-D-G21	
	GW8.3-BAT-D-G20	

Equipment Type	model	Description
	GW8.3-BAT-D-G21	<ul style="list-style-type: none"> • Different model battery module supports mixed usage. • System support 5-96kWh, meeting the usage requirements of different Power and energy matching. • When GW5.1-BAT-D-G20, GW8.3-BAT-D-G20 are used in combination with GW5.1-BAT-D-G21, GW8.3-BAT-D-G21, the operating ambient temperature requirements shall be based on GW5.1-BAT-D-G21 and GW8.3-BAT-D-G21.
Smart Meter	Built-in energy meter (shipped with Inverter)	<ul style="list-style-type: none"> • Built-in energy meter: Please use the CT provided in the package to connect to Inverter. <ul style="list-style-type: none"> ◦ CT ratio is 120A:40mA. ◦ When the built-in meter of Inverter does not meet the requirements, you can contact the dealer to purchase GMK110 or GM330 Smart Meter. • GMK110: CT replacement is not supported, CT ratio is 120A:40mA • GM330: CT can be sourced from GoodWe or purchased separately, with a CT ratio of nA:5A. • Inverter If a generator connection is required, use GMK110 or GM330 Smart Meter.
	GMK110 (purchased from GoodWe)	
	GM330 (purchased from GoodWe)	

Equipment Type	model	Description
Smart dongle	WiFi/LAN Kit-20	<ul style="list-style-type: none"> • Suitable for single-unit networking of Inverter and scenarios involving Parallel Networking. • Configure device parameters and view operational information via Bluetooth signals for local access, while uploading system operational data to the monitoring platform through WiFi or LAN. • To use one-click upgrade, operation log export, and other functions, ensure that the WiFi/LAN Kit-20 software version is V2.3 or higher.
	4G Kit-CN-G20 (China Only)	<ul style="list-style-type: none"> • Only applicable to single-unit networking scenarios of Inverter. • Configure device parameters and view operational information via Bluetooth signals for local access, while uploading system operation data to the monitoring platform through 4G. • InverterTo use one-click upgrade, operation log export, and other functions, ensure that the 4G Kit-CN-G20 version is 05 or above.

Microgrid Scenario

When grid-tied PV inverter is connected to hybrid inverter BACK-UP port, it is Microgrid Scenario.

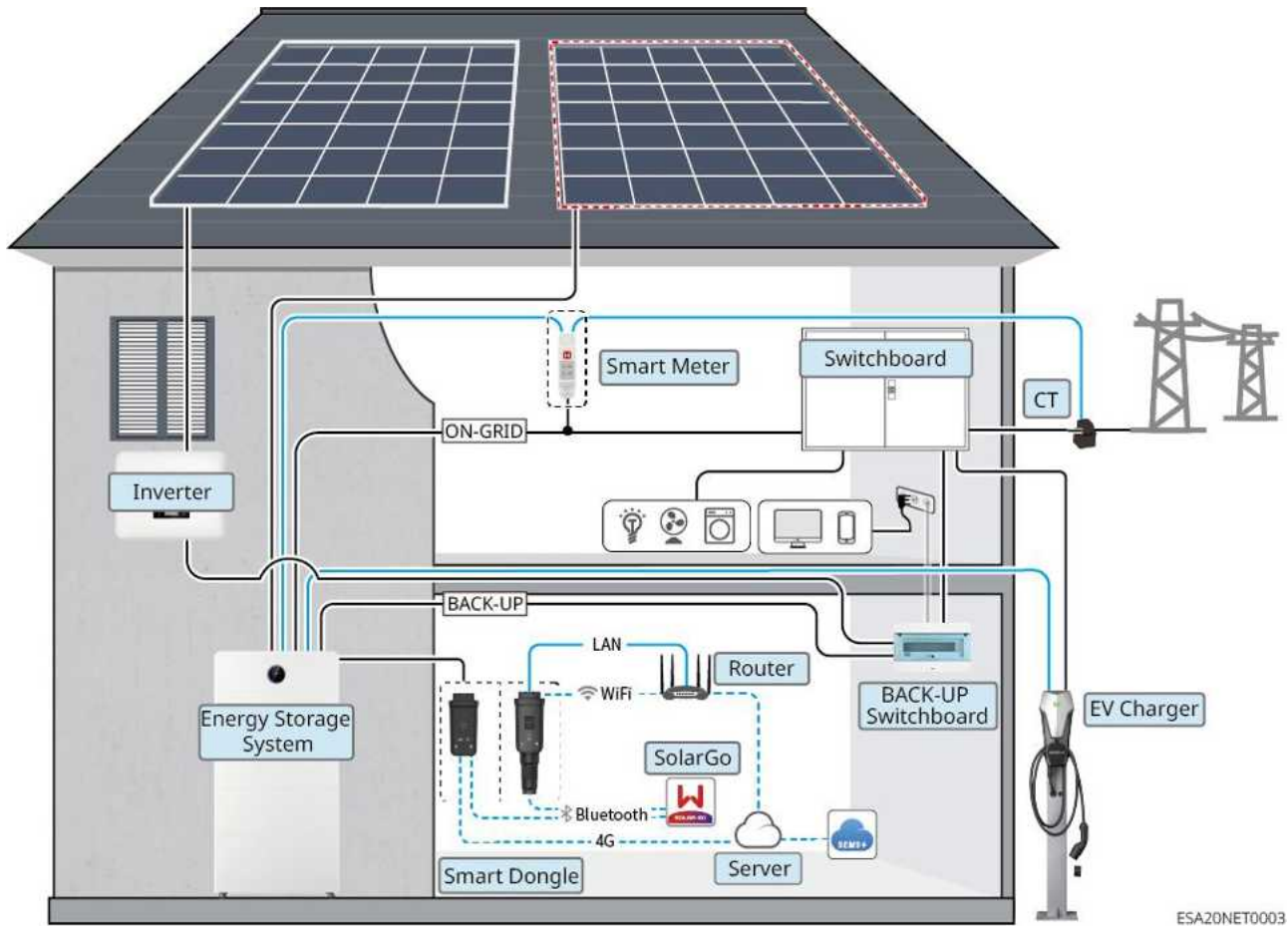

ESA20NET0003

Equipment Type	model	Instructions
hybrid inverter	GW3K-EHA-G20	
	GW3.6K-EHA-G20	
	GW5K-EHA-G20	
	GW6K-EHA-G20	
	GW8K-EHA-G20	
	GW9.999K-EHA-G20	
	GW10K-EHA-G20	
	GW3K-BHA-G20	

Equipment Type	model	Instructions
	GW3.6K-BHA-G20 GW5K-BHA-G20 GW6K-BHA-G20 GW8K-BHA-G20 GW9.999K-BHA-G20 GW10K-BHA-G20	<ul style="list-style-type: none"> • In Microgrid Scenario, the system only supports the use of one hybrid inverter. • Microgrid Scenario does not support generator connection. • The system networking meets the following version requirements: <ul style="list-style-type: none"> ◦ Inverter ARM software version is 02.99 and above. ◦ Inverter DSP software version is 03.3010 and above. ◦ SolarGo software version is 6.9.0 or above.
Battery system	GW5.1-BAT-D-G20 GW5.1-BAT-D-G21 GW8.3-BAT-D-G20 GW8.3-BAT-D-G21	<ul style="list-style-type: none"> • Different model battery module supports mixed usage. • System support 5-96kWh, meeting the needs of different Power and energy matching applications. • When GW5.1-BAT-D-G20, GW8.3-BAT-D-G20 are mixed with GW5.1-BAT-D-G21, GW8.3-BAT-D-G21, the operating ambient temperature requirements shall follow those of GW5.1-BAT-D-G21 and GW8.3-BAT-D-G21.
Smart Meter	Built-in meter (shipped with Inverter) GMK110 (purchased from GoodWe)	

Equipment Type	model	Instructions
	GM330 (purchased from GoodWe)	<ul style="list-style-type: none"> • Built-in energy meter: Please connect Inverter using the CTs shipped with the cabinet. <ul style="list-style-type: none"> ◦ CT ratio is 120A:40mA ◦ When the built-in meter of Inverter does not meet the requirements, you can contact the dealer to purchase GMK110 or GM330 Smart Meter. • GMK110: CT replacement is not supported, CT ratio is 120A:40mA • GM330: CT can be sourced from GoodWe or purchased separately, with a CT ratio of nA:5A.
Smart dongle	WiFi/LAN Kit-20	<ul style="list-style-type: none"> • Suitable for single-unit networking of Inverter and Parallel Networking scenarios. • Configure device parameters and view operational information via Bluetooth signals for local access, while uploading system operational data to the monitoring platform through WiFi or LAN. • InverterTo use one-click upgrade, operation log export, and other functions, ensure that the WiFi/LAN Kit-20 software version is V2.3 or above.

Equipment Type	model	Instructions
	4G Kit-CN-G20 (China Only)	<ul style="list-style-type: none"> • Only applicable to single-unit networking scenarios of Inverter. • Configure device parameters and view operational information via Bluetooth signals for local access, while uploading system operation data to the monitoring platform through 4G. • InverterTo use functions such as one-click upgrade and operation log export, ensure that the 4G Kit-CN-G20 version is 05 or above.

Equipment Type	model	Instructions
grid-tied PV inverter	-	<ul style="list-style-type: none"> • It is recommended to use the GoodWe brand grid-tied PV inverter, and third-party grid-tied PV inverter is supported. • In Microgrid Scenario, ensure that grid-tied PV inverterNominal output power ≤ hybrid inverterNominal output power. • When the microgrid system is in the on-grid state, if Power limitation is required, please ensure: <ul style="list-style-type: none"> ◦ hybrid inverter needs to be configured through the SolarGo App Export power limit interface. grid-tied PV inverter Please set it according to the actual tools used. ◦ To ensure the grid-tied PV inverter can operate continuously for power generation, it is necessary to adjust the output Power of the hybrid inverter through the microgrid mode interface in the SolarGo App. <p>Note: The output Power Control accuracy varies with different grid-tied PV inverter. Please set the Export power limit parameter value according to actual conditions.</p>

Coupling scenario

When grid-tied PV inverter is connected to hybrid inverter ON-GRID port, it is a coupled scenario.

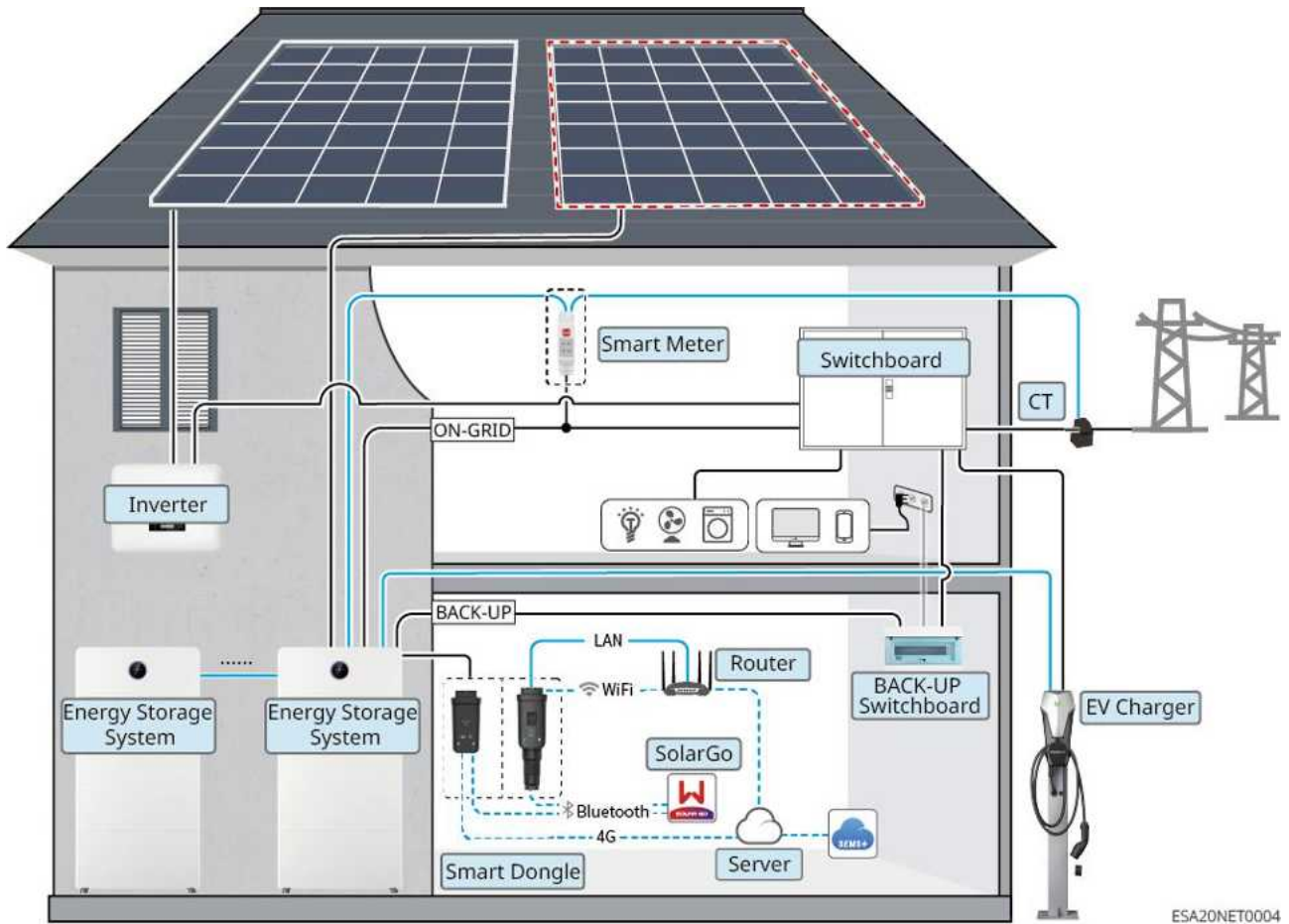

ESA20NET0004

Equipment Type	model	Instructions
hybrid inverter	GW3K-EHA-G20	
	GW3.6K-EHA-G20	
	GW5K-EHA-G20	
	GW6K-EHA-G20	
	GW8K-EHA-G20	
	GW9.999K-EHA-G20	
	GW10K-EHA-G20	
	GW3K-BHA-G20	

Equipment Type	model	Instructions	
	GW3.6K-BHA-G20	<ul style="list-style-type: none"> • Only in standalone mode, it supports Diesel Generator Control, with the generator supplying power to Battery charge. • The system supports a maximum of 6 Inverter units to form a parallel system, allowing mixed parallel operation of Inverter On/Off-grid with different Power segments. • In a parallel system, if the GW3K/3.6K/5K/6K models are mixed with the GW8K/9.999K/10K models, please set the GW8K/9.999K/10K models as Master inverter. • To connect a generator or Parallel Networking, use GMK110 or GM330 Smart Meter. If more than two Inverter units are to be paralleled, use GM330 Smart Meter. • In a parallel system, each Inverter requires a Installation WiFi/LAN Kit-20, with the software version requirement being V2.5 or higher. • The system networking must meet the following version requirements: <ul style="list-style-type: none"> ◦ Inverter ARM software version is 02.99 and above. ◦ Inverter DSP software version is 03.3010 and above. ◦ SolarGo software version is 6.9.0 or above. 	
	GW5K-BHA-G20		
	GW6K-BHA-G20		
	GW8K-BHA-G20		
	GW9.999K-BHA-G20		
	GW10K-BHA-G20		
Battery system	GW5.1-BAT-D-G20		
	GW5.1-BAT-D-G21		
	GW8.3-BAT-D-G20		

Equipment Type	model	Instructions
	GW8.3-BAT-D-G21	<ul style="list-style-type: none"> • Different model battery module supports mixed usage. • System support 5-96kWh, meeting the usage requirements of different Power and energy matching. • When GW5.1-BAT-D-G20, GW8.3-BAT-D-G20 are used in combination with GW5.1-BAT-D-G21, GW8.3-BAT-D-G21, the operating ambient temperature requirements shall be based on GW5.1-BAT-D-G21 and GW8.3-BAT-D-G21.
Smart Meter	Built-in energy meter (shipped with Inverter)	<ul style="list-style-type: none"> • Built-in energy meter: Please use the CTs shipped with the cabinet to connect to Inverter. <ul style="list-style-type: none"> ◦ CT ratio is 120A:40mA ◦ When the built-in meter of Inverter does not meet the requirements, you can contact the dealer to purchase GMK110 or GM330 Smart Meter. • GMK110: CT cannot be replaced, CT ratio is 120A:40mA. • GM330: CT can be sourced from GoodWe or purchased separately, with a CT ratio of nA:5A. • Inverter If a generator connection is required, use GMK110 or GM330 Smart Meter.
	GMK110 (purchased from GoodWe)	
	GM330 (purchased from GoodWe)	

Equipment Type	model	Instructions
Smart dongle	WiFi/LAN Kit-20	<ul style="list-style-type: none"> • Suitable for single-unit networking of Inverter and scenarios involving Parallel Networking. • Configure device parameters and view operational information via Bluetooth signals for local access, while uploading system operational data to the monitoring platform through WiFi or LAN. • To use one-click upgrade, operation log export, and other functions, ensure that the WiFi/LAN Kit-20 software version is V2.3 or higher.
	4G Kit-CN-G20 (China Only)	<ul style="list-style-type: none"> • Only applicable to single-unit networking scenarios of Inverter. • Configure device parameters and view operational information via Bluetooth signals for local setup, and upload system operational data to the monitoring platform via 4G. • InverterTo use one-click upgrade, operation log export, and other functions, ensure that the 4G Kit-CN-G20 version is 05 or above.

Equipment Type	model	Instructions
grid-tied PV inverter	-	<ul style="list-style-type: none"> • It is recommended to use GoodWe brand grid-tied PV inverter, and third-party grid-tied PV inverter is supported. • In the coupling scenario, ensure that grid-tied PV inverterNominal output power \leq hybrid inverterNominal output power. • When the coupling system is in the on-grid state, if Power limitation is required, please ensure: hybrid inverter must be set through the Export power limit interface in the SolarGo App, and grid-tied PV inverter should be configured according to the actual tools used. <p>Note: The output Power Control accuracy varies for different grid-tied PV inverter. Please set the Export power limit parameter value according to the actual situation.</p>

2.2 Product Overview

2.2.1 Single-phase all-in-one system for residential use

Single-phase all-in-one residential system

The residential single-phase all-in-one unit integrates the Battery and Inverter through modular design, utilizing a blind-mate stacking connection method.

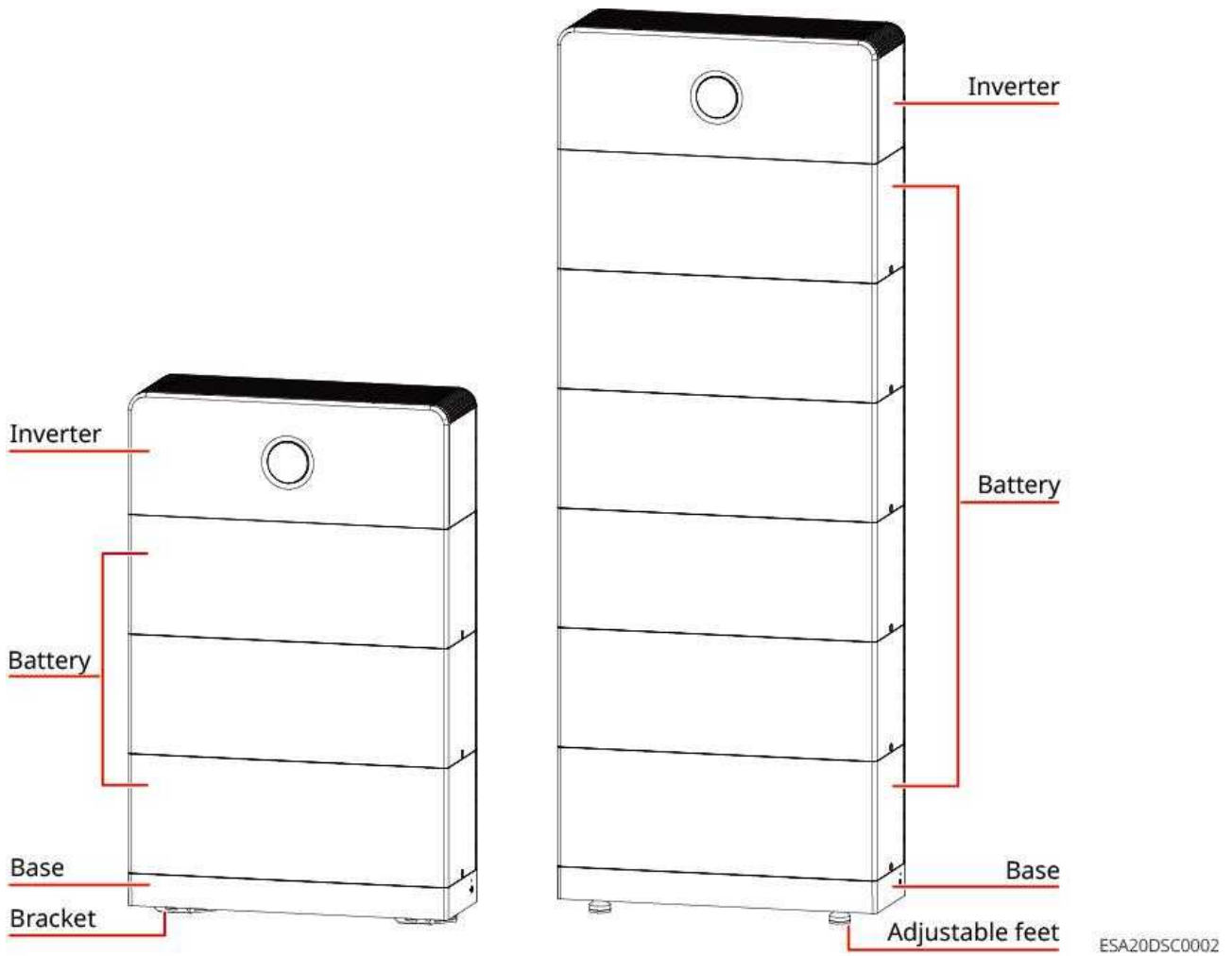

energy storage system supports Battery capacity expansion. The total capacity of Battery is determined by the quantity and specifications of the Battery modules. Configuration must strictly adhere to the constraints specified in this section. System overall configuration instructions:

Mounting Method	Battery total count	Expansion group count	Single-group stacking
ground-mounted Installation	≤12block	≤3Group	≤6block
Wall-mounted Installation (5kWhModel)	≤9block	≤3Group	≤3block
Wall-mountedInstallation (8kWh/5kWh+8kWh) Model)	≤6block	≤3Group	≤2block

Mounting Method	Battery total count	Expansion group count	Single-group stacking
Note: Number of expansion groups × Single group stacking quantity ≤ Total number of Battery in the system			

ground-mounted Installation

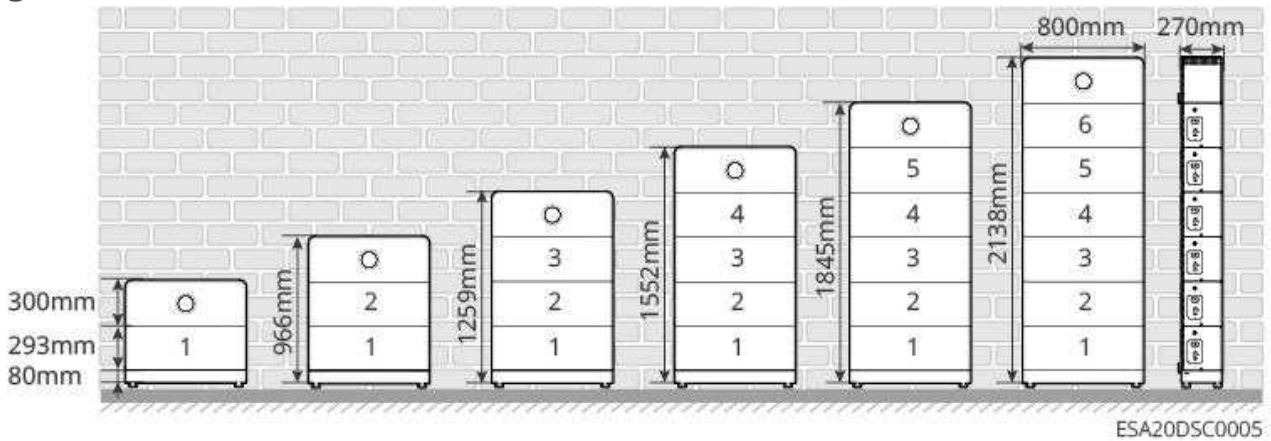

Wall-mounted Installation

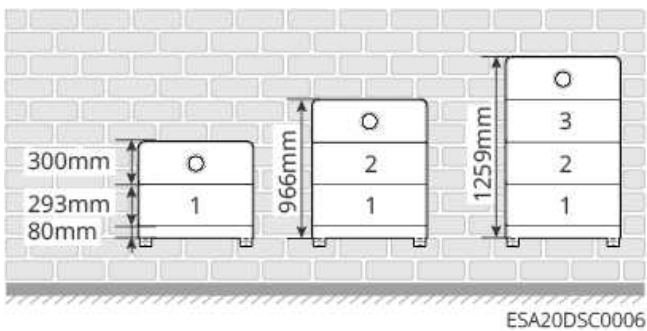

Cluster Expansion Installation

ground-mounted Installation

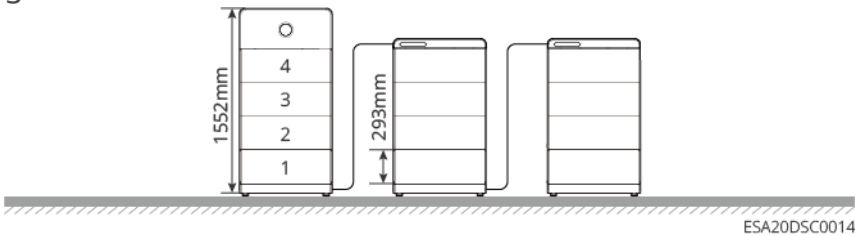

Wall-mounted Installation

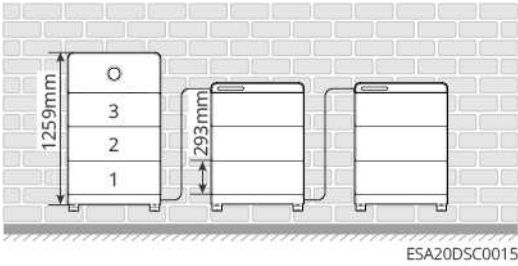

Inverter:

Inverter controls and optimizes power through an integrated energy management system in photovoltaic systems. The electricity generated by the PV system can be supplied to loads, stored in Battery, or exported to Utility grid.

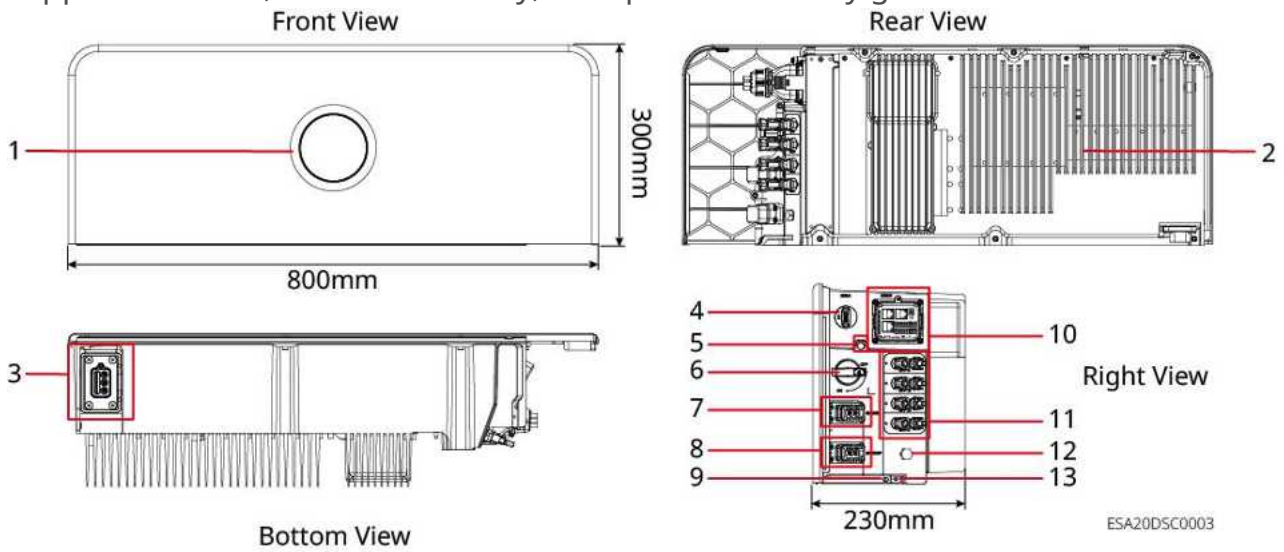

No.	Component/Silkscreen	Description
1	indicator	Indicates the working status of Inverter.
2	heat sink	Heat dissipation.
3	Connector	Inverter and Battery connected Power, Communication Port.
4	smart dongle connection port	<ul style="list-style-type: none"> It can be connected to smart dongle, such as WiFi/LAN Kit-20 and 4G Kit-CN-G20. Please select the module type according to actual requirements. Supports USB connection for Local Upgrade Inverter software version updates.

No.	Component/Silkscreen	Description
5	Lifting rod Installation hole	Used for Installation lifting rod. Used when transporting Inverter.
6	DC Switch	Only for EHA model, BHA model does not have DC Switch. Control the connection or disconnection of DC input.
7	Grid-Tied	Connect the AC line, connect Inverter to Utility grid.
8	BACK-UP端口	Connect the AC line, connect critical loads or grid-tied PV inverter.
9	Batteryfixing hole	Fixed Inverter and Battery.
10	Communication Port	Can be connected to load control, CT, RS485, Remote Shutdown/Rapid Shutdown, DRED (Australia)/RCR (Europe), and other Communication cable.
11	PV Input terminal	Only for EHA model, no PV input for BHA model terminal. Can connect DC input lines of PV modules. PV input terminal quantity is as follows: <ul style="list-style-type: none"> • GW3K-EHA-G20, GW3.6K-EHA-G20, GW5K-EHA-G20, GW6K-EHA-G20: 2 • GW8K-EHA-G20, GW9.999K-EHA-G20, GW10K-EHA-G20: 4
12	Ventilation valve	-
13	Grounding terminal	Connection box PE cable

Battery:

Battery system can store and release electrical energy according to the requirements of the photovoltaic energy storage system. The input and output port of this energy storage system are both high-voltage direct current.

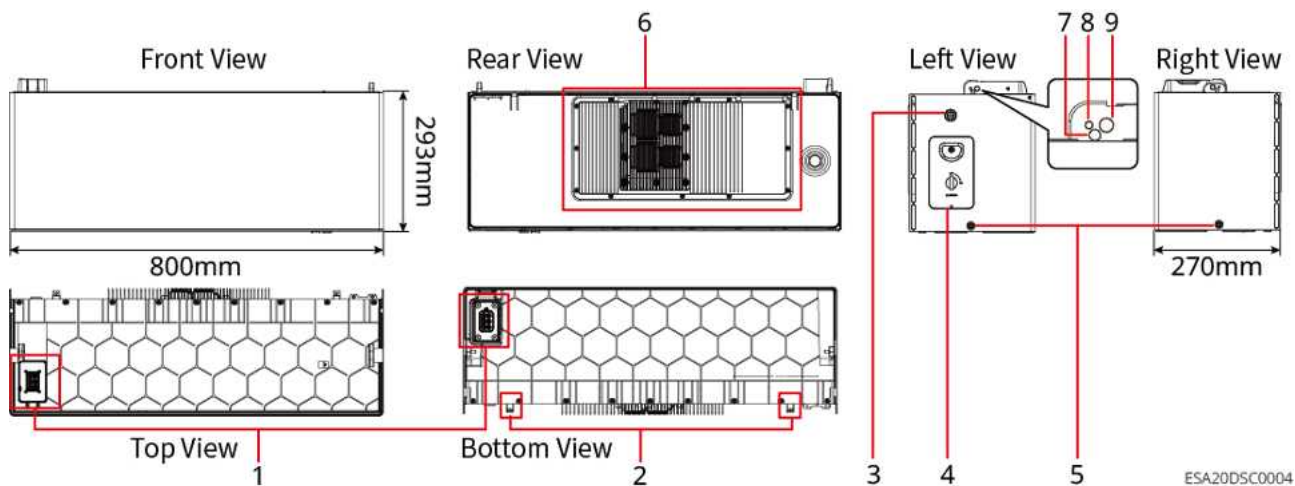

ESA20DSC0004

No.	Component	Instructions
1	Connector	Battery and Battery, Battery and Inverter connected Power, Communication Port.
2	locking bracket fixing hole	Used for fixing Battery to the wall.
3	Multi-function button indicator	<ul style="list-style-type: none"> Indicates the Battery operating status. Battery Black Start Function: When there is no PV power generation in the photovoltaic system and the Utility grid is abnormal, the Inverter cannot operate normally. Press and hold the multifunction button for 2 seconds to start the Battery system, activate the Inverter, and enable the Inverter to operate in off-grid mode, allowing the Battery discharge to supply power to the load. Batterypower off Function: Press and hold the multifunction button for >5s to Battery systempower off.
4	disconnecter	Power input/output switch.
5	Battery interval fixing hole	Fixed between two Battery.
6	heat sink	Battery heat dissipation

No.	Component	Instructions
7	Batteryhoisting hole	Used for hoisting Battery. When stacking more than three pieces, lifting tools must be used for hoisting.
8	Battery or Inverterfixing hole	Used for fixing between Battery or between Inverter and Battery.
9	Lifting rod Installation hole	Used for Installation lifting rod. Manual handling Battery is used.

2.2.2 Smart Meter

The smart meter can measure and monitor the data in the photovoltaic energy storage system, such as voltage, current, frequency, power factor, and power, etc.

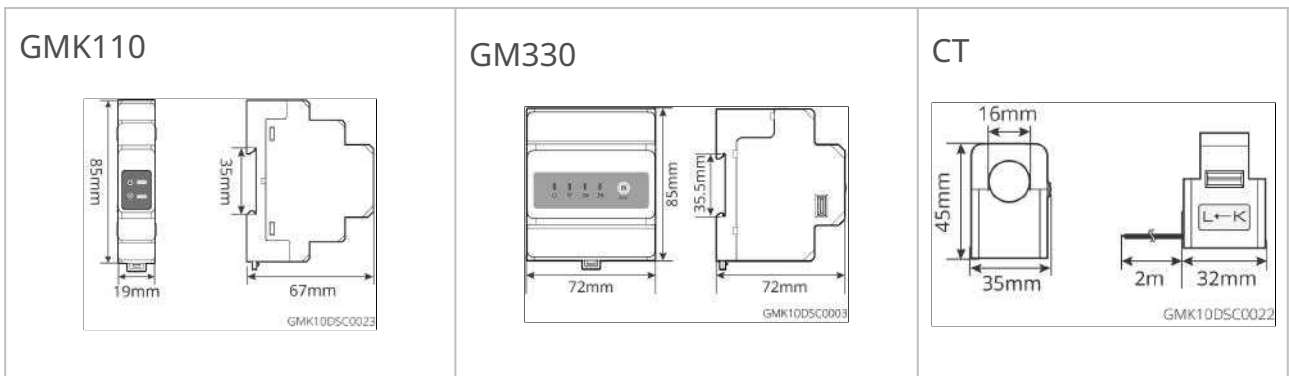

No.	Model	Applicable scenarios
1	GMK110	It is not supported to change the CT to other type, CT ratio: 120A: 40mA
2	GM330	Supports purchasing from GOODWE or third-party, CT ratio requirement: nA: 5A <ul style="list-style-type: none"> nA: CT Primary side input current, the range of n is 200-5000 5A: CT Secondary side output voltage.

2.2.3 Smart Dongle

The smart dongle can transmit various power generation data to the remote monitoring platform, in real time, and can communicate with the SolarGo App to complete the near-end equipment commissioning.



No.	Model	Signal	Applicable scenarios
1	WiFi/LAN Kit-20	WiFi, LAN, Bluetooth	Single inverter scenario, multi inverter scenario
2	4G Kit- CN-G20 (Only for China)	4G、 Bluetooth	Single inverter scenario

2.3 Supported Grid Types

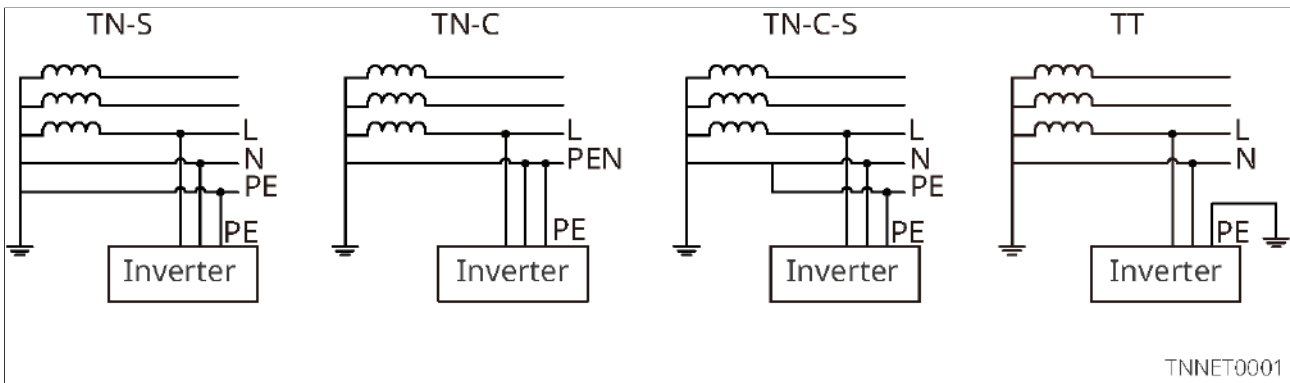

2.4 System Working Mode

Self-use Mode

- Self-use mode is the basic working mode of the system.
- The power generated by the PV system supply the loads in priority; the excess power will charge the batteries, and then the remaining power will be sold to the utility grid. When the power generated in the PV system is insufficient, the battery will supply the loads in priority. If the battery power is insufficient, the load will be powered by the utility grid.

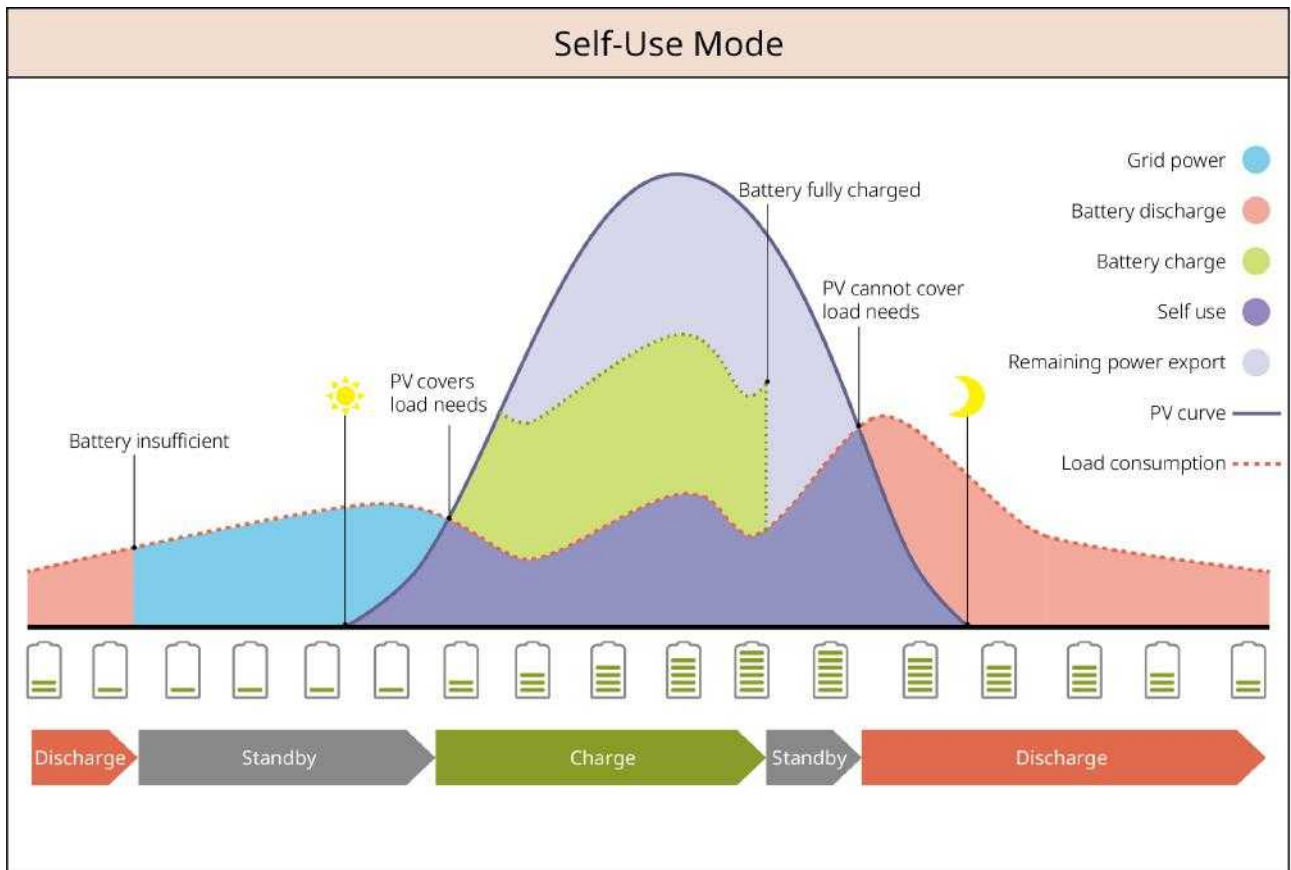

SLG00NET0009

BACK-UP Mode

- The BACK-UP mode is mainly applied to the scenario where the grid is unstable.
- When the grid is disconnected, the inverter turns to off-grid mode and the battery will supply power to the BACK-UP loads; when the grid is restored, the inverter switches to on-grid mode.
- To ensure that the battery SOC is sufficient to maintain normal operation of the system when it is off grid, the battery will be charged to the backup power SOC using PV or grid power during on-grid operation. If you need to purchase electricity from the power grid to charge the battery, please confirm compliance with local power grid laws and regulations.

Back-up Mode ①

Charging from grid: disabled

Back-up SOC: 60%

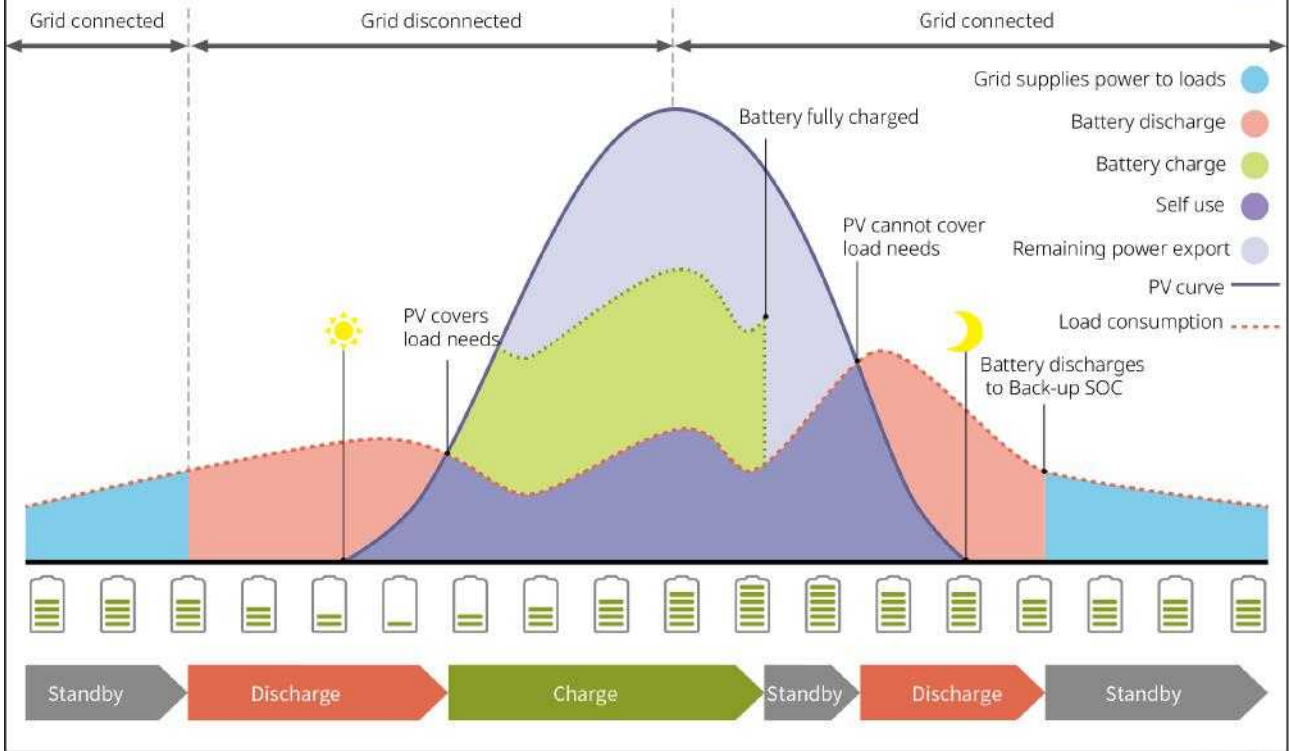

SLG00NET0002

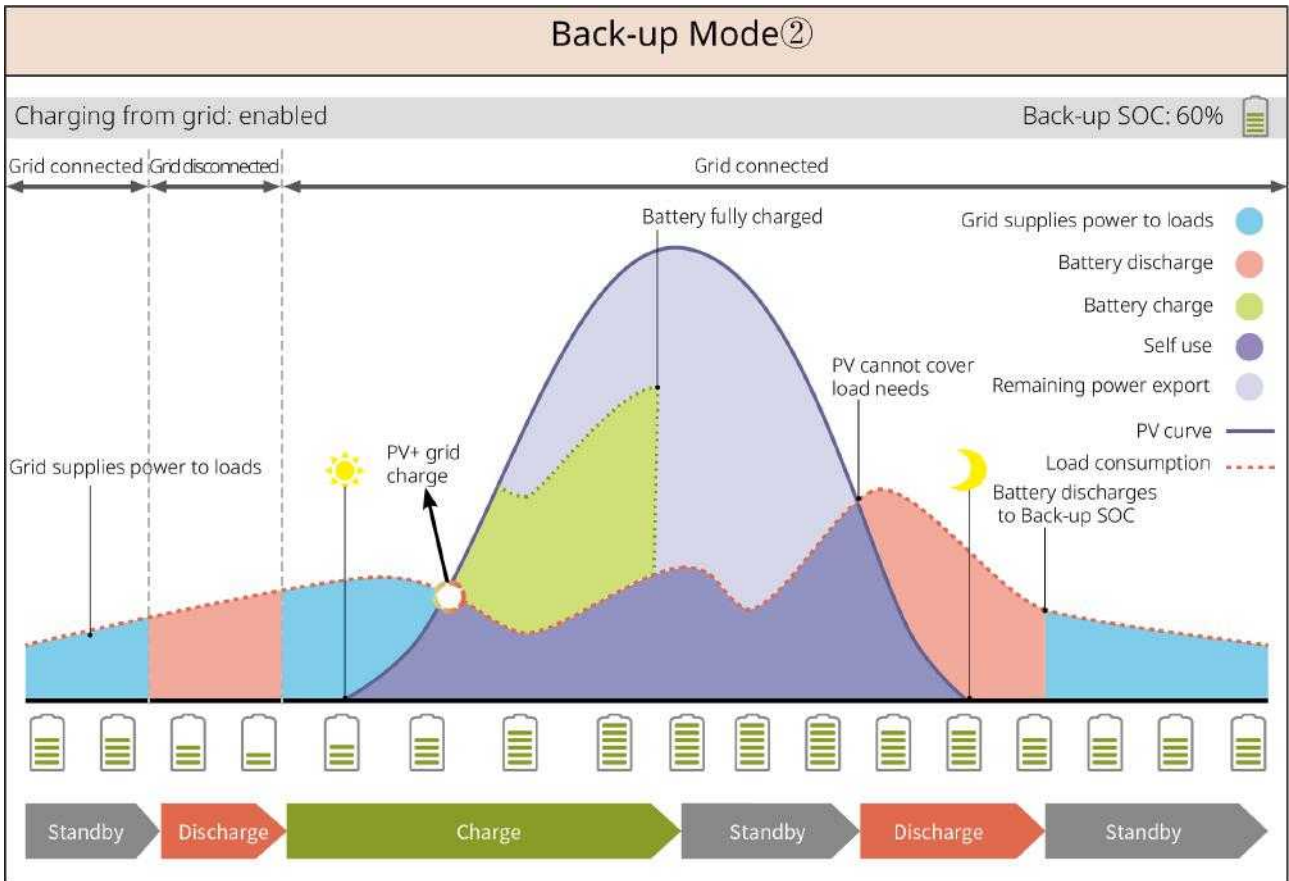

SLG00NET0003

TOU Mode

It is recommended to use TOU mode in scenarios when the peak-valley electricity price varies a lot. Select TOU mode only when it meets the local laws and regulations. For example, set the battery to charge mode during Valley period to charge battery with grid power. And set the battery to discharge mode during Peak period to power the load with the battery.

TOU Mode①

PV: Charge battery in priority

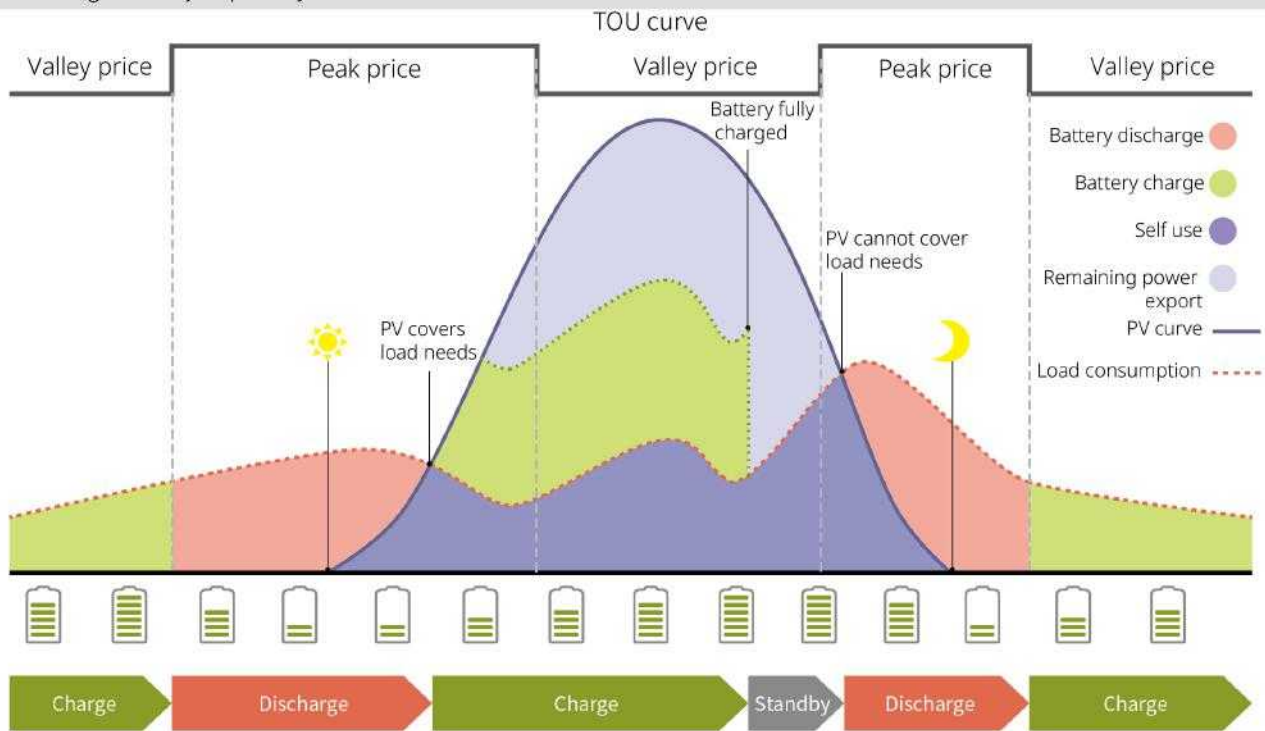

SLG00NET0004

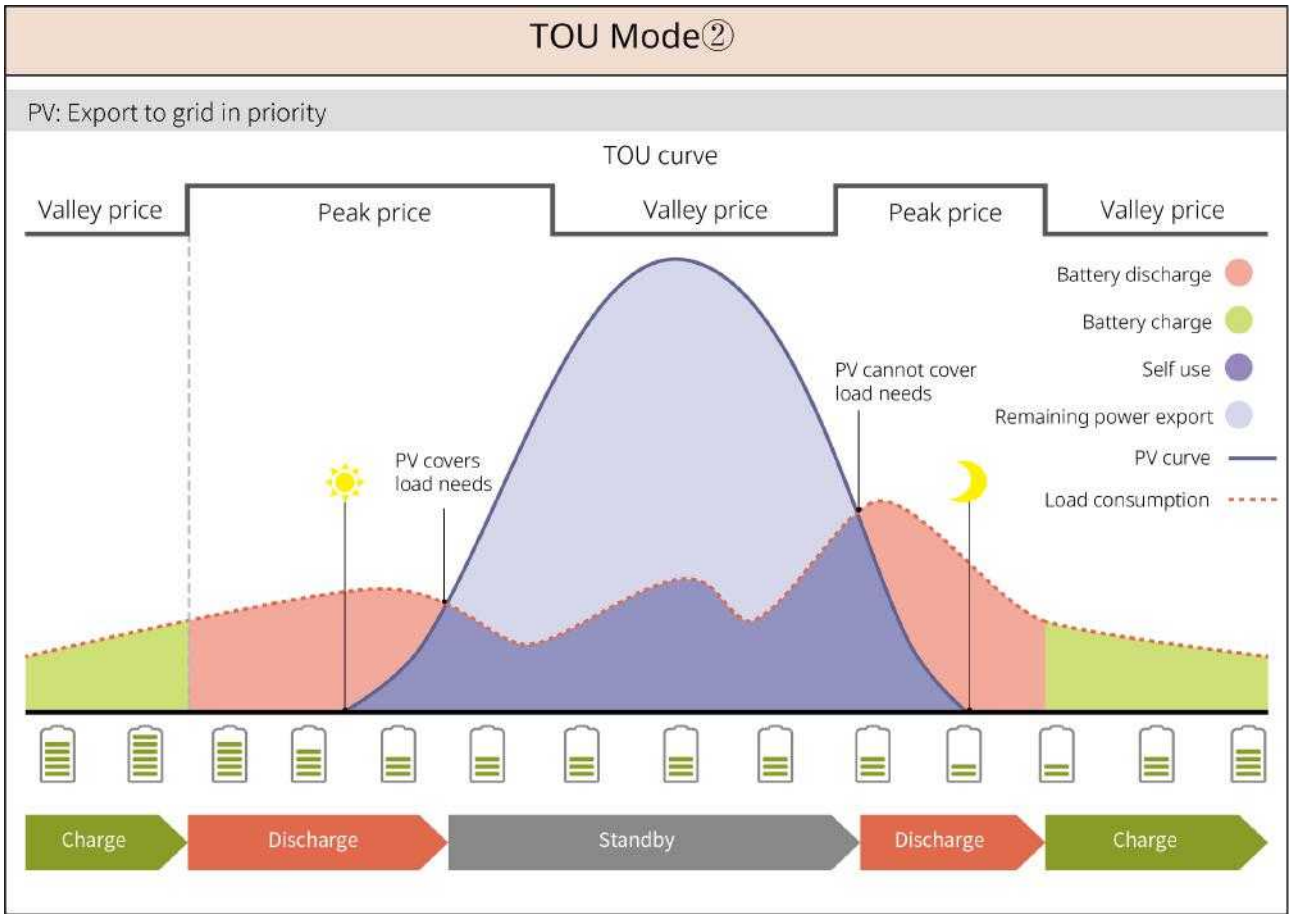

SLG00NET0005

Delayed Charging Mode

- Suitable for areas with on-grid power output restrictions.
- Setting a peak power limit allows the PV power that exceeds the on-grid limit to be used to charge the battery; or setting a PV charging time period, during which the PV power is utilized to charge the battery.

Smart Charging ①

PV > Peak Limit

Switch to Charge: enabled/disabled

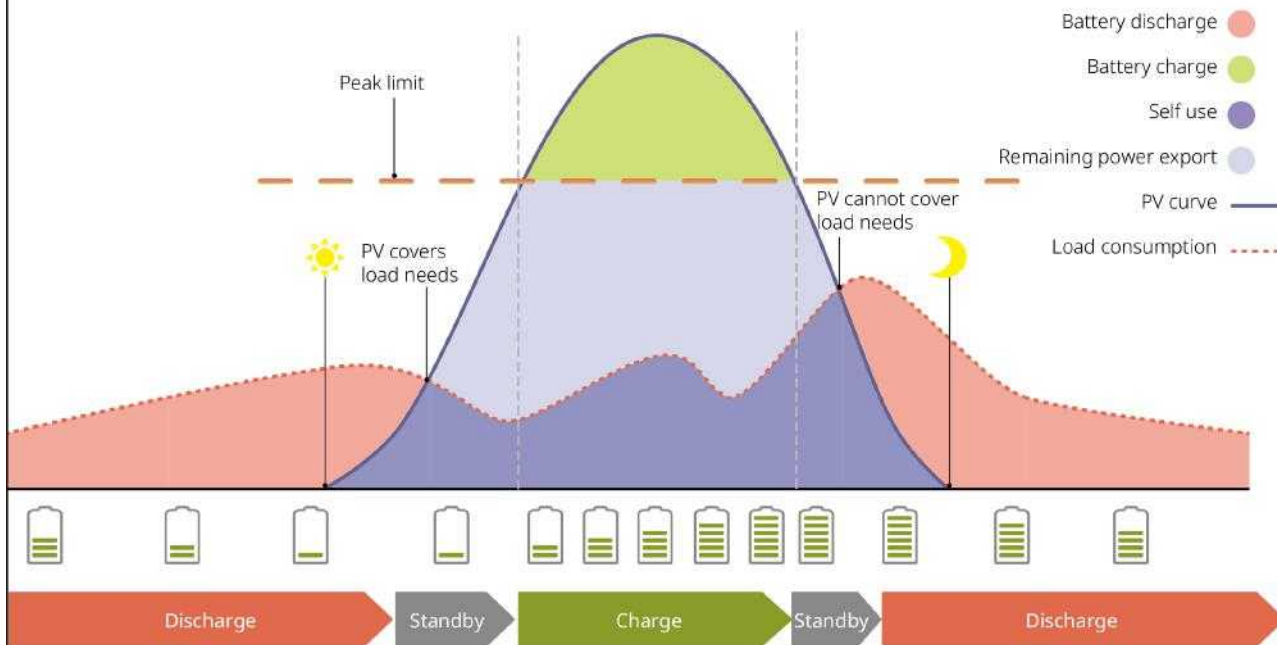

SLG00NET0006

Smart Charging ②

PV < Peak Limit

Switch to Charge: enabled

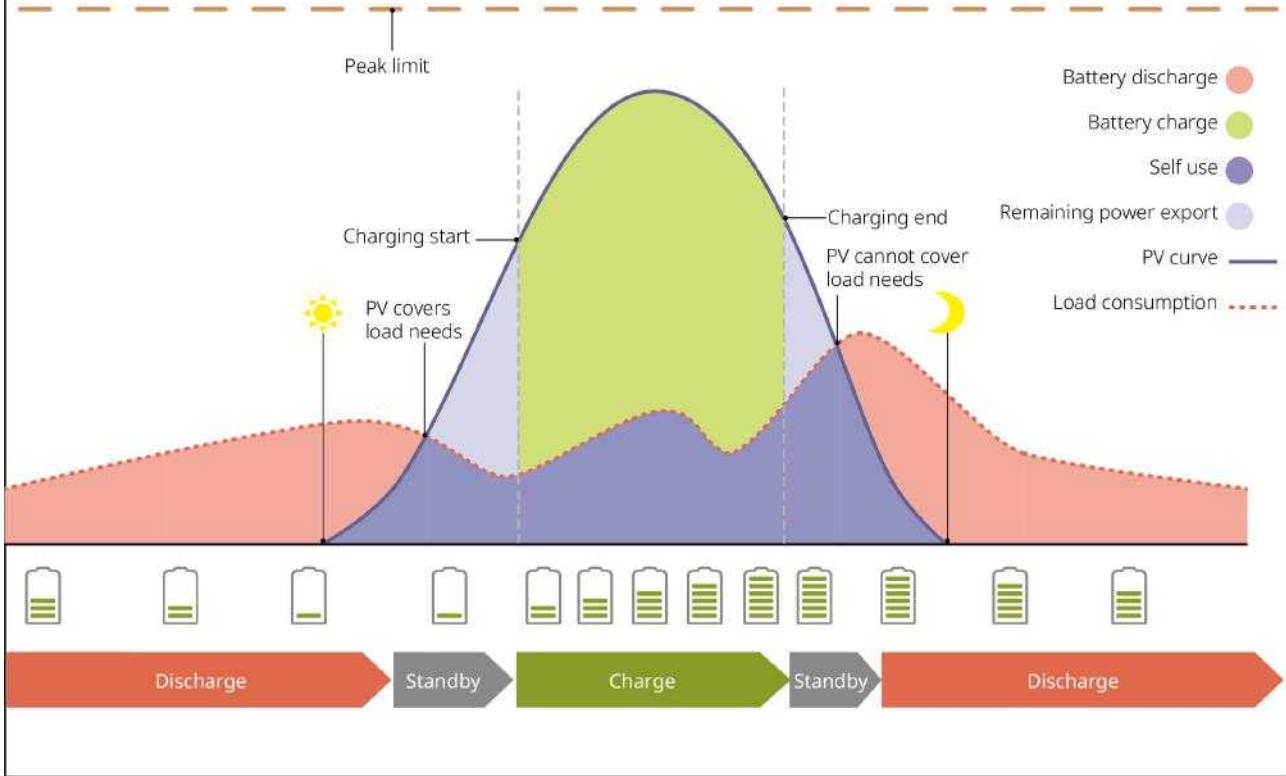

SLG00NET0007

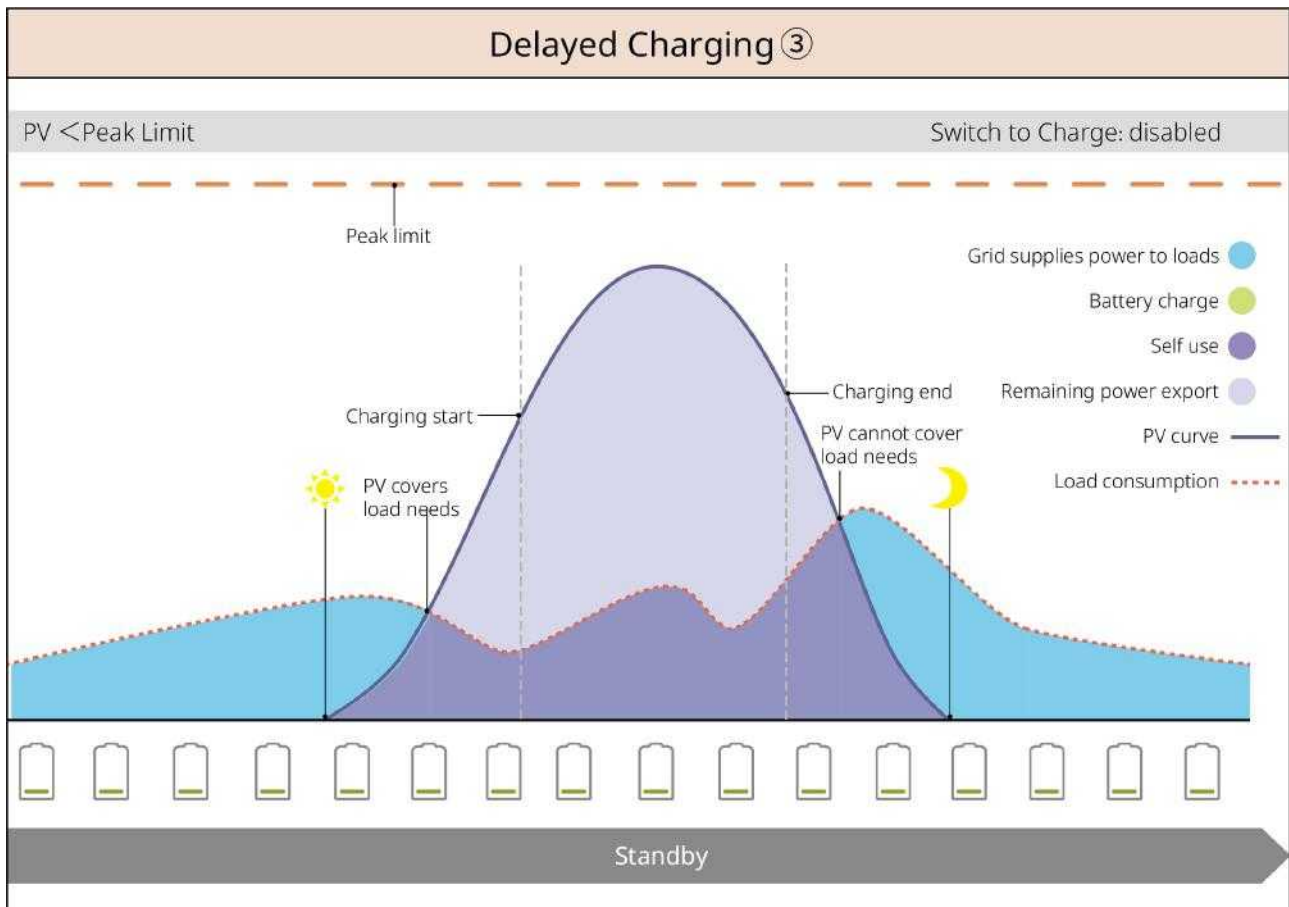

Demand Management Model

- It is mainly applicable to industrial and commercial scenarios.
- When the total power consumption of the load exceeds the power quota within a short period of time, battery discharge can be used to reduce the amount of power consumption exceeding the quota.
- When the battery SOC is below the reserved SOC for demand management, the system buys power from the grid based on the time period, load power usage, and the peak power buy limit.

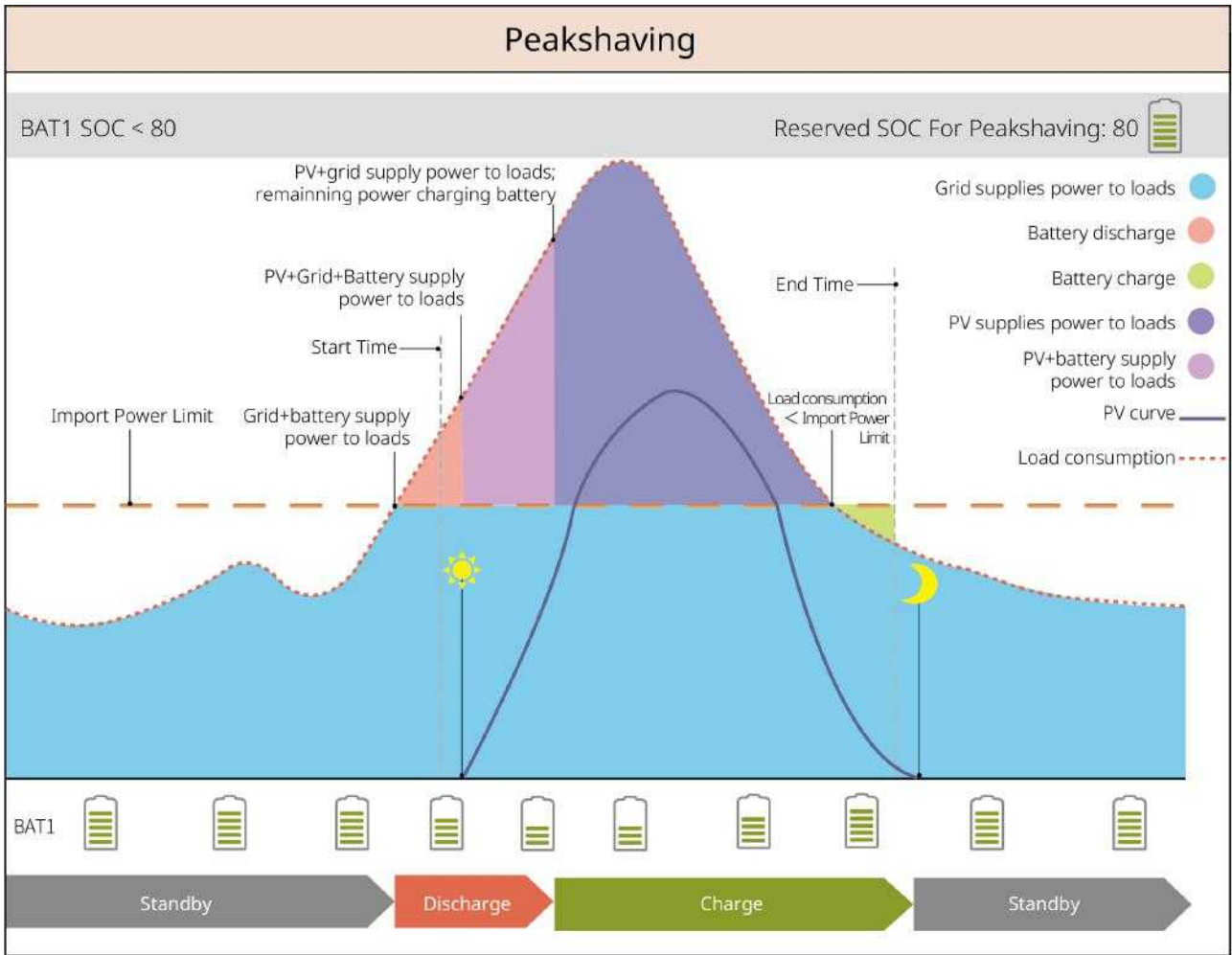

SLG00NET0001

Off-grid Mode

NOTICE

Please do not operate the energy storage system in pure off-grid mode for long periods of time, otherwise there is a risk of over-discharge when the battery cannot be charged in low temperature or low light conditions.

When the power grid fails, the inverter switches to off-grid mode.

- During the day, PV power generation is prioritized for supplying power to loads, and excess power is used to charge batteries.
- Nighttime battery discharge powers the load to ensure uninterrupted power supply to the backup load.

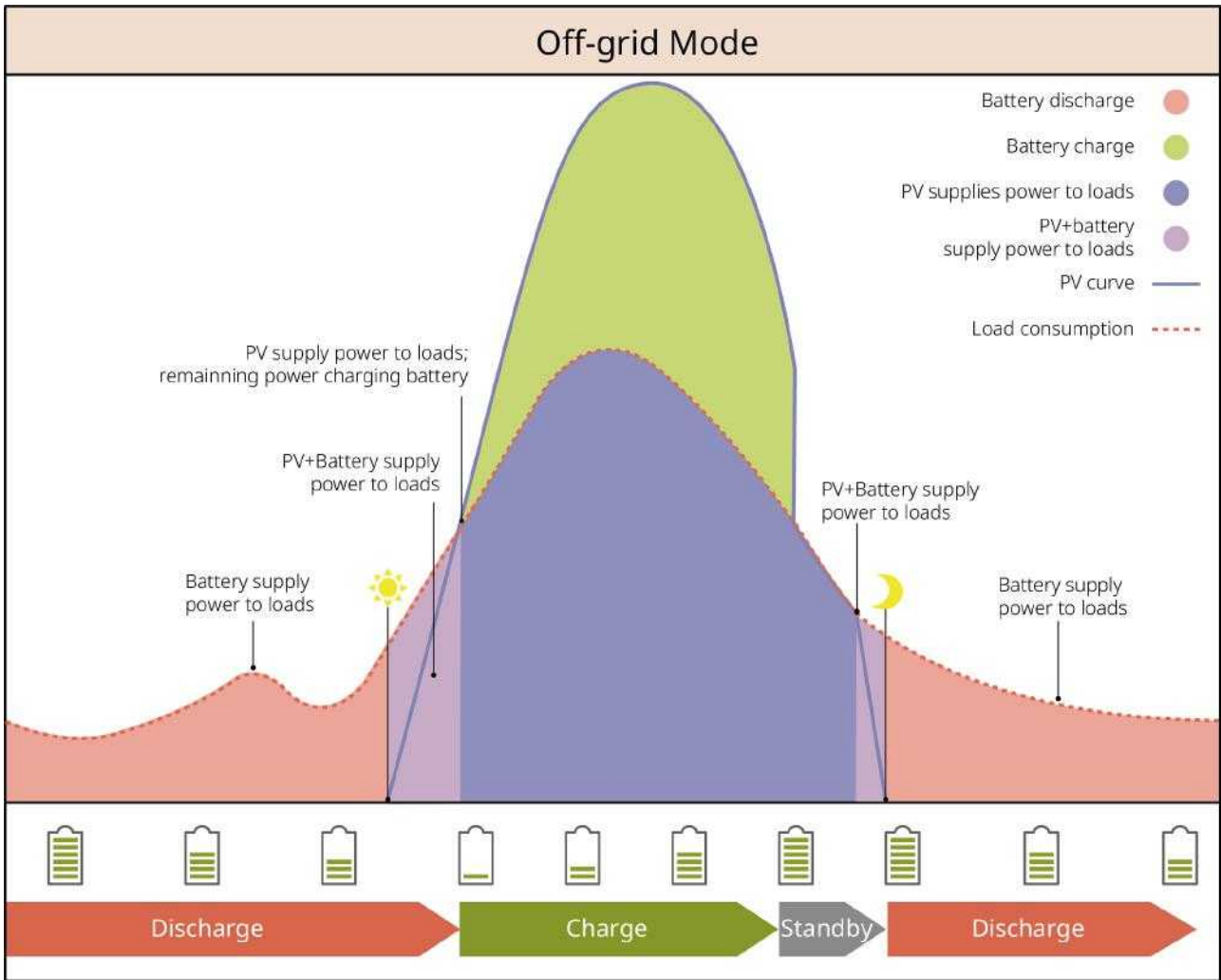

SLG00NET0012

2.5 Features

NOTICE

For specific Features, please refer to the actual product configuration.

AFCI

Inverter Integrated AFCI Circuit Protection device, used to detect Arc Fault (arc fault) and quickly disconnect the POWER OFF circuit when detected, thereby preventing electrical fires.

Causes of arc generation:

- Connectors in the photovoltaic system are damaged.
- Cable connection error or damage.

- Connector and cable aging.

Troubleshooting method:

1. When an arc is detected, the fault type can be viewed on the Inverter display or via the App.
2. If fault is triggered fewer than 5 times within 24 hours, the machine will automatically restore on-grid Protection after a 5-minute wait. After the 5th Arc Fault, Inverter can only resume normal operation after clearing fault. For specific operations, please refer to the "SolarGo APP User Manual."

model	Label	Instructions
GW3K-EHA-G20 GW3.6K-EHA-G20 GW5K-EHA-G20 GW6K-EHA-G20	AFCI: F-I-AFPE-1-2-1	F: Full coverage I: Integrated AFPE: Detection and interruption capability provided 1: 1 monitored string per input port 2: 2 input ports per channel 1: 1 monitored channel
GW8K-EHA-G20 GW9.999K-EHA-G20 GW10K-EHA-G20	AFCI: F-I-AFPE-1-2/2-2	F: Full coverage I: Integrated AFPE: Detection and interruption capability provided 1: 1 monitored string per input port 2/2: 2/2 input ports per channel(AFD1: 2 , AFD2: 1) 2: 2 monitored channels

load control

Inverter Dry contact control port, supports connection of additional contactors for controlling load switching on/off. Compatible with household loads, heat pumps, etc. The load control method is as follows:

- Time Control: Set the time for turning the load on or off. The load will automatically turn on or off within the set time period.

- Switch Control: When the control mode is set to ON, the load will be turned on; when the control mode is set to OFF, the load will be turned off.
- BACK-UP Loads Control: Inverter Built-in relay dry contact control port. The relay can be used to control whether the load is turned off. In off-grid mode, if the Overload Battery SOC value detected at the BACK-UP terminal is lower than the off-grid Protection set value of Battery, the load connected to the relay port can be turned off.

Rapid Shutdown(RSD)快速关断

In a Rapid Shutdown system, the Rapid Shutdown transmitter works in conjunction with the receiver to achieve system Rapid Shutdown. The receiver maintains module output by receiving signals from the transmitter. The transmitter can be externally mounted or integrated into the Inverter. In emergency situations, the transmitter can be deactivated by enabling an external trigger device, thereby shutting down the module.

- External transmitter
 - Transmitter model: GTP-F2L-20, GTP-F2M-20
<https://www.goodwe.com/Ftp/Installation-instructions/RSD2.0-transmitter.pdf>
 - Receiver model: GR-B1F-20, GR-B2F-20
https://en.goodwe.com/Ftp/EN/Downloads/User%20Manual/GW_RSD-20_Quick-Installation-Guide-POLY.pdf
- Built-in transmitter
 - External trigger device: external switch
 - Receiver model: GR-B1F-20, GR-B2F-20
https://en.goodwe.com/Ftp/EN/Downloads/User%20Manual/GW_RSD-20_Quick-Installation-Guide-POLY.pdf

3 Check and Storage

3.1 Check Before Receiving





Check the following items before accept.





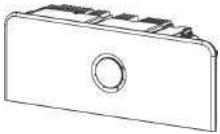

1. Check the outer packing box for damage, such as holes, cracks, deformation, and other signs of equipment damage. Do not unpack the package and contact the supplier as soon as possible if any damage is found.
2. Check the product model. If the product model is not what you requested, do not unpack the product and contact the supplier.



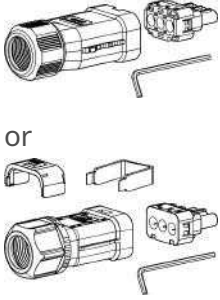
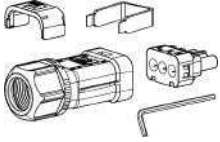

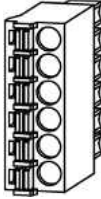

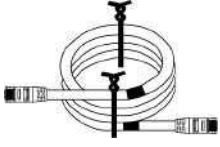
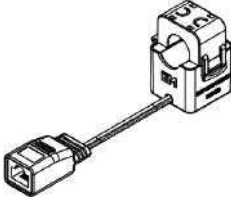
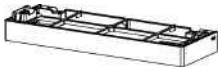
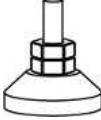
3.2 Deliverables

 WARNING			
Check the deliverables for correct model, complete contents, and intact appearance. Contact the supplier as soon as possible if any damage is found.			

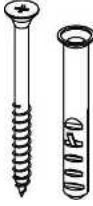
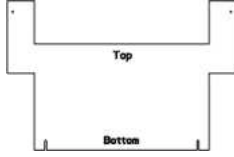
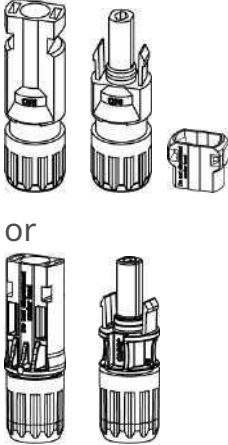

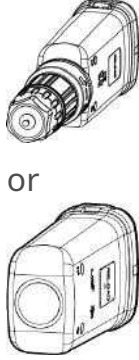
3.2.1 Inverter Deliverables

Component	Instructions	Component	Description
	Inverter x 1		Decorative Cover Top x 1
	Decorative cover left x 1	<div style="display: flex; align-items: center;"> <div style="border: 1px dashed black; padding: 2px; margin-right: 5px;">  </div> <div style="border: 1px dashed black; padding: 2px;">  </div> </div>	Decorative cover right x 1

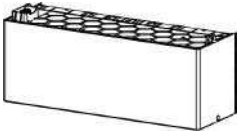

Component	Instructions	Component	Description
 <p>or</p> 	AC wiring terminal x 2		Handle x 2
	OT Grounding terminal x 1		6PIN communication terminal x 2
	2PIN communication terminal x 2		PIN terminal x 16
	CT connecting wire x 1		CT x 1
	BatteryBase x 1		Adjustable feet x 4
	Anti-tip bracket x 4		M5*16 screw x 9

Component	Instructions	Component	Description
	<p>M5*60Expansion screw x 4</p>		<p>Punch mark paper x 2</p>
 <p>or</p>	<p>PVterminal and PVterminal anti-tamper cover x N GW3K-EHA-G20、GW3.6K-EHA-G20、GW5K-EHA-G20、GW6K-EHA-G20: 4 GW8K-EHA-G20、GW9.999K-EHA-G20、GW10K-EHA-G20: 8 Note: No PVterminal anti-tamper cover in China region GW3K-BHA-G20、GW3.6K-BHA-G20、GW5K-BHA-G20、GW6K-BHA-G20、GW8K-BHA-G20、GW9.999K-BHA-G20、GW10K-BHA-G20: 0</p>	  <p>or</p> 	<p>PVterminal Unlocking Tool x N N: China region x 0; Other regions x 1.</p> <p>Smart dongle x 1</p>
	<p>Product Documentation x 1</p>		<p>Manual Transfer Switch (Australia Only) x 1 Note: For single-unit scenarios only.</p>

3.2.2 Batteries Deliverables

Component	Description	Component	Description
	Battery x1		M5*16 bolts x 2
	Silicone cap x 2	-	-

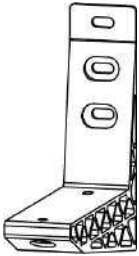
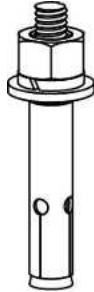





Hanger installation (optional)



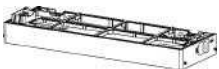

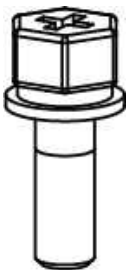
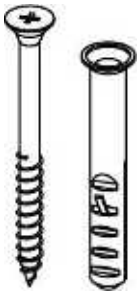
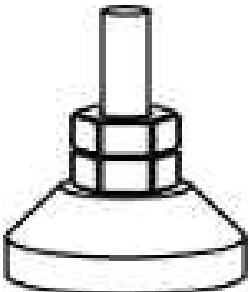

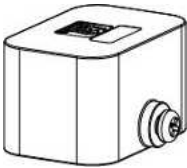

Component	Description	Component	Description
	Bracket x 2		M10 Expansion bolts x 6
	M10 bolts x 4	-	-

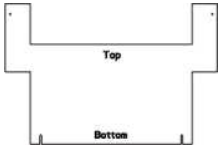
3.2.2.1 Battery Expansion Kit deliverables

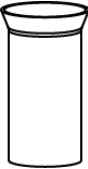
NOTICE

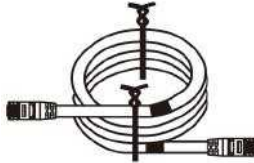

The system supports 5-96kWh. A single stack can accommodate up to 6 Battery units, with a maximum capacity of 48kWh. For scenarios requiring additional energy, or when Installation conditions necessitate reducing the stack height per string or other expansion needs, please contact GoodWe or authorized dealers to purchase the Battery expansion kit.



Component	Instructions	Component	Instructions
	Base x 1		locking bracket x 4
	M5 x 7		M6 x 4
	Adjustable feet x 4		OT Grounding terminal x 1
	Terminal resistor x 1		Decorative cover x 1

Component	Instructions	Component	Instructions
	Punch mark paper x 2		Cluster expansion harness x 1
	PIN terminal x 8		Expansion cluster connection positive harness x 1
	Expansion cluster connection negative harness x 1		Expansion cluster network cable x 1
	Cap x 2		Handle x 2
	Hex key wrench x 1		Product Documentation x 1

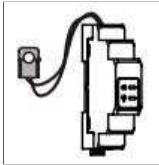



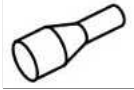

3.2.3 Smart Meter Deliverables

3.2.3.1 GMK110

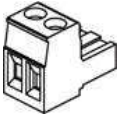
Component	Description	Component	Description
	Smart Meter and CT x 1		RS485 communication terminals x 1

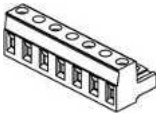
Component	Description	Component	Description
	Voltage input side terminal x 1		PIN terminal x 4
	Screw driver x 1		Documents x 1

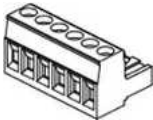
3.2.3.2 GM330

Component	Description	Component	Description
	Smart meter and CT x1		2PIN communication terminal x1
	PIN terminal x 6		7PIN terminal x1
	Screwdriver x1		6PIN communication terminal x1
	2PIN terminal to RJ45 terminal adapter cable x 1		Product documentation x 1

3.3 Storage

- If the inverter has been stored for more than two years or has not been in operation for more than six months after installation, it is recommended to be inspected and tested by professionals before being put into use.
- To ensure good electrical performance of the internal electronic components of the inverter, it is recommended to power it on every 6 months during storage. If it has not been powered on for more than 6 months, it is recommended to be

inspected and tested by professionals before being put into use.

- In order to protect the performance and service life of the battery, it is recommended to avoid unused storage for a long period of time. Prolonged storage may cause deep discharging of the battery, resulting in irreversible chemical loss, leading to capacity degradation or even complete failure, timely use is recommended. If the battery needs to be stored for a long period of time, please maintain it according to the following requirements:

Notice

[1] The storage time starts from the SN date on the outer packaging of the battery and requires charging and discharging maintenance after the storage cycle is exceeded. (Battery maintenance time = SN date + charging/discharging maintenance cycle). For SN date, refer to [14.4.Battery SN Code Meaning\(Page 363\)](#)

[2] After passing the charging/discharging maintenance, if there is a Maintaining Label attached to the outer box, then please update the maintenance information on the Maintaining Label. if there is no Maintaining Label, please record the maintenance time and SOC of the batteries and keep the data to facilitate the keeping of maintenance records.

Battery type	Initial SOC Range for Battery Storage	Storage Temperature (°C)	Charge and Discharge Maintaining Period ^[1]	Battery Maintenance Method ^[2]
GW5.1-BAT-D-G20	35~45%	0~35°C	-20~35°C, 12months 35~45°C, 6 months	Contact the dealer or the after-sales service for maintenance method.
GW8.3-BAT-D-G20				
GW5.1-BAT-D-G21				
GW8.3-BAT-D-G21				

Packing requirements:

Do not unpack the outer package or throw the desiccant away.

Environment Requirements:

1. Place the equipment in a cool place where away from direct sunlight.
2. Store the equipment in a clean place. Make sure the temperature and humidity are appropriate and no condensation. Do not install the equipment if the ports or terminals are condensed. Battery storage temperature range:
3. Keep the equipment away from flammable, explosive, and corrosive matters.

Stacking requirements:

1. The height and direction of the stacking inverter should follow the instructions on the packing box.
2. The inverter must be stacked with caution to prevent them from falling.

4 Installation



Install and connect the equipment with the deliverables included in the package. Otherwise, the manufacturer shall not be liable for the damage.

4.1 Installation Requirements

4.1.1 Installation Environment Requirements

1. Do not install the equipment in a place near flammable, explosive, or corrosive materials.
2. The temperature and humidity at the installation site should be kept within the appropriate range.
3. Keep away from children.
4. High temperatures may exist on the surface of the equipment during operation to prevent burns.
5. Install the equipment in a sheltered place to avoid direct sunlight, rain, and snow. Build a sunshade if it is needed.
6. The place to install the equipment shall be well-ventilated for heat radiation and large enough for operations.
7. Check the protection rating of the equipment and ensure that the installation environment meets the requirements. The inverter, battery system, and smart dongle can be installed both indoors and outdoors, but the smart meter can only be installed indoors.
8. Install the equipment at a height that is convenient for operation and maintenance, electrical connections, and checking indicators and labels.
9. The altitude to install the inverter shall be lower than the maximum working altitude of the system.
10. Consult the manufacturer before installing the equipment outdoors in salt affected areas. A salt-affected area refers to the region within 500 meters offshore, and will be related to the sea wind, precipitation and topography.
11. Install the equipment away from electromagnetic interference. If there is any radio or wireless communication equipment below 30MHz near the equipment, you have to:

- Inverter: add a multi-turn winding ferrite core at the AC output cable of the inverter, or add a low-pass EMI filter. Or the distance between the inverter and the wireless EMI equipment should be more than 30m.
- Other equipment: the distance between the equipment and the wireless EMI equipment should be more than 30m.

NOTICE

- Inverter Operating Temperature Range: -35°C-60°C.
- GW5.1-BAT-D-G20, GW8.3-BAT-D-G20: Charging temperature range: -18°C-55°C; Discharging temperature range: -20°C-55°C. If installed in an environment below -18°C, the battery will not be able to continue charging to restore energy after being discharged, resulting in undervoltage protection.
- GW5.1-BAT-D-G21, GW8.3-BAT-D-G21: Charging temperature range: 2°C-55°C; Discharging temperature range: -20°C-55°C. If installed in an environment below 2°C, the battery will not be able to continue charging to restore energy after being discharged, resulting in undervoltage protection.

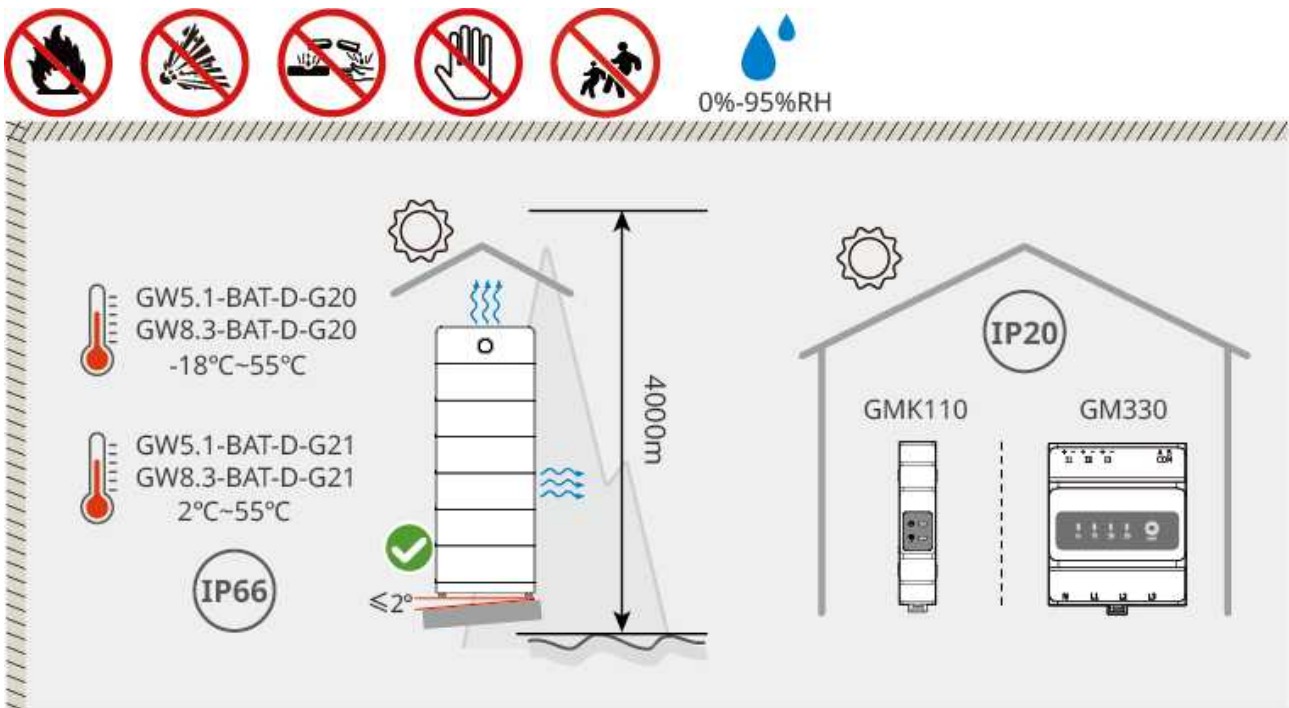

4.1.2 Installation Space Requirements

Reserve enough space for operations and heat dissipation when installing the

system.

- When using CAT 7E communication cables among inverters, the maximum distance can reach 10 meters, while using CAT 5E or CAT 6E communication cables, the maximum distance can reach 5 meters. The length of the communication cable should not exceed 10 meters; otherwise, it may cause communication abnormality.
- For the installation of the CT, a shielded network cable of CAT 5E or higher grade must be used, and the cable length should not exceed 30 meters.
- For the RS485 twisted-pair shielded cable used for communication between the inverter and the smart meter, the cable length should not exceed 100 meters.

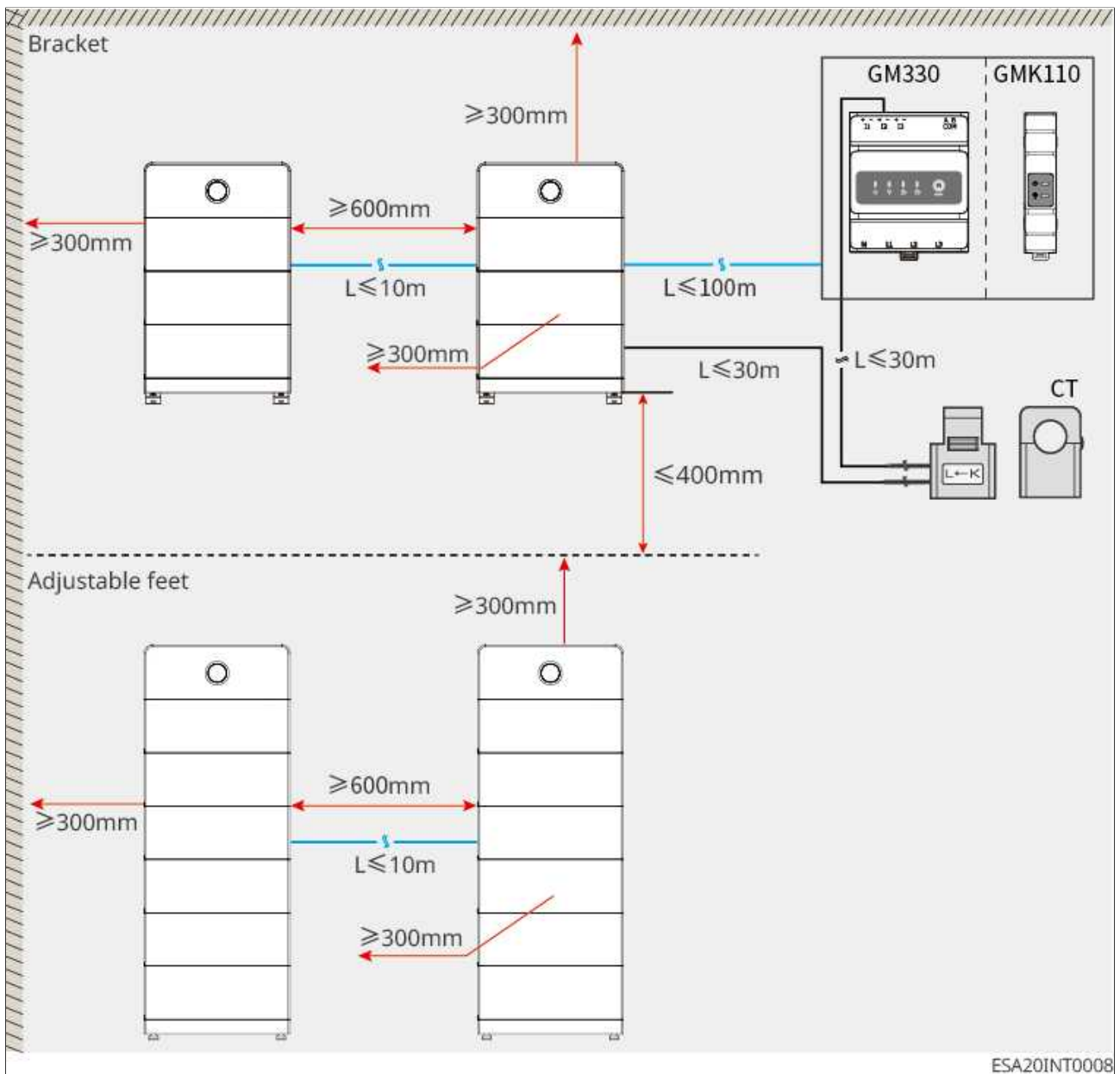

















4.1.3 Tool Requirements

NOTICE

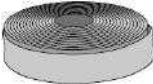

The following tools are recommended when installing the equipment. Use other auxiliary tools on site if necessary.

Installation Tools

Tool Type	Description	Tool Type	Description
	Diagonal pliers		RJ45 crimping tool
	Wire stripper		Level ruler
	Adjustable wrench		PV connector tool PV-CZM-61100
	Impact drill (drill bits Φ12mm)		Torque wrench M4, M5, M6, M10
	Rubber hammer		Socket wrench set
	Marker		Multimeter Range≤600V
	Heat shrink tube		Heat gun

Tool Type	Description	Tool Type	Description
	Cable tie		Vacuum cleaner
	(Only for China) PV Unlocking tool x1	-	-

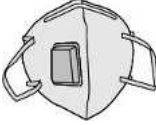
Personal Protective Equipment

Tool Type	Description	Tool Type	Description
	Insulating gloves, protective gloves		Dust mask
	Goggles		Safety shoes

4.2 Equipment Handling

⚠ CAUTION

- Operations such as transportation, turnover, installation and so on must meet the requirements of the laws and regulations of the country or region where inverters are installed.
- Move the equipment to the site before installation. Follow the instructions below to avoid personal injury or equipment damage.
 1. Consider the weight of the equipment before moving it. Assign enough personnel to move the equipment to avoid personal injury.
 2. Wear safety gloves to avoid personal injury.
 3. Keep balance to avoid falling down when moving the equipment.
 4. The battery system can be transported to the installation site by crane.
 5. When moving equipment using a hoisting method, please use flexible slings or straps. The load-bearing capacity of a single strap must meet the following requirements:
 - GW5.1-BAT-D-G20, GW5.1-BAT-D-G21 $\geq 180\text{KG}$
 - GW8.3-BAT-D-G20, GW8.3-BAT-D-G21 $\geq 240\text{KG}$

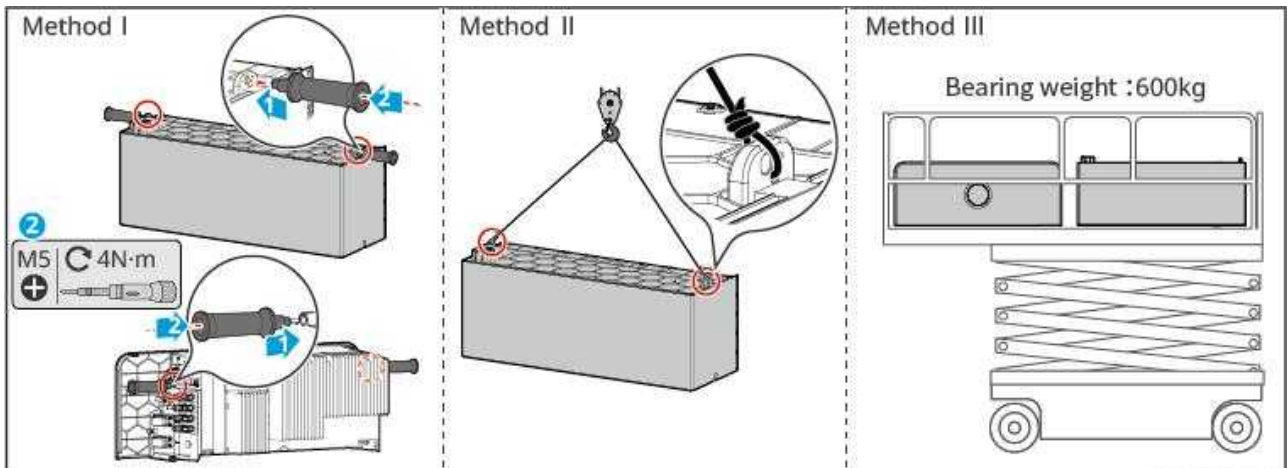

ESA20INT0010

4.3 Installation equipment

 **CAUTION**

- When drilling, ensure the hole position avoids water pipes, cables, etc. inside the wall to prevent DANGER.
- When drilling, wear goggles and a dust mask to prevent dust from inhalation entering the respiratory tract or falling into the eyes.
- Inverter is located above Battery. Do not place Battery Installation above Inverter.
- When Battery system Installation, ensure the Installation is level and secure. When placing the Battery Base, Battery, and Inverter, confirm that the holes on the upper and lower layers are aligned. The locking bracket should be vertically flush with the ground, wall, or Battery system surface.
- When using hammer drill for punching, use cardboard or other protective coverings to shield Battery system to prevent foreign objects from entering the equipment and causing damage.
- When mounting on a wall Installation, ensure the wall's load-bearing capacity is assessed to protect your life and property.

NOTICE

- Battery requires Installation on the Base, and Base can be installed on the ground Installation or mounted on a bracket Installation.
- When using BaseInstallation, it supports stacking up to 6 Battery modules.
- The maximum stacking quantity when using the bracket Installation is specified as follows:
 - Same energy stacking
 - GW5.1-BAT-D-G20 and GW5.1-BAT-D-G21: Up to 3 units.
 - GW8.3-BAT-D-G20 and GW8.3-BAT-D-G21: Maximum of 2 units.
 - Different energy aliasing:
 - When GW5.1-BAT-D-G20, GW5.1-BAT-D-G21 are mixed with GW8.3-BAT-D-G20, GW8.3-BAT-D-G21, the entire system supports a maximum of 2 units.
- The Base, bracket, and the uppermost Battery must be secured to the wall using locking bracket.
- When marking the drilling positions on the bracket Installation, have one person hold the Base steady while another uses a marker to mark the drilling locations.
- When Installing the Battery System and Inverter, remove the protective cover dismantle on the blind-mate connector before stacking.

Wall-mounted Installation

Step 1:Mount the Base Installation on the bracket.

Step 2:The bracket is tightly attached to the wall. Ensure the bracket is securely placed, and observe the level bubble in the center of the Base.

Step 3:After adjusting the position and levelness of the mounting bracket, use a marker to mark the drilling positions. Once marked, remove the bracket. (A: PACKfixing hole position; B: Bracketfixing hole position.)

Step 4:Punch holes and InstallationExpansion screw.

1. Use hammer drill for punching holes.
2. Clean the holes.
3. Use rubber hammer to insert Expansion screw Installation into the hole.
4. Use a hex wrench to tighten the nut clockwise to expand the screw.
5. Rotate the nut counterclockwise to remove.
6. Use torque screwdriver to fasten locking bracket to the wall.

Step 5: Use a hex key to secure the bracket to the wall.

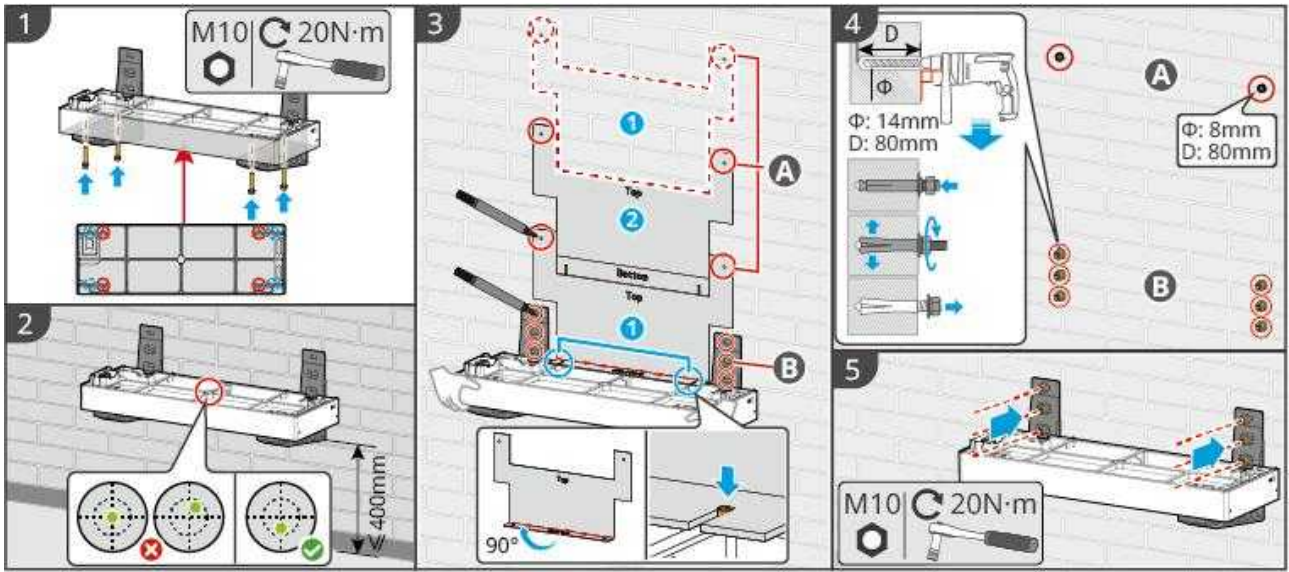

ESA20INT0003

Installation Base

Step 1: Adjust the adjustable foot Installation at the bottom of Base, and secure the locking bracket onto the Base.

Step 2: Place Base 50-60 cm away from the wall. Place it parallel to the wall. Observe the level bubble in the center of the Base. If the bubble is not centered, adjust it using the leveling feet.

Step 3: After adjusting the position and level of Base, use the hole marking paper to mark the drilling positions. Once marked, remove the Base. (A: PACK fixing hole position; B: Bracket fixing hole position.)

Step 4: Use a hammer drill for drilling and clean the holes.

Step 5: Secure the locking bracket to the wall using cross screwdriver fasteners.

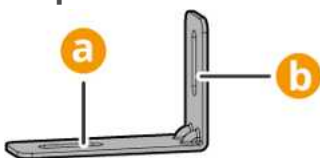

a: Fixed surface with Base; b: Fixed surface with wall.

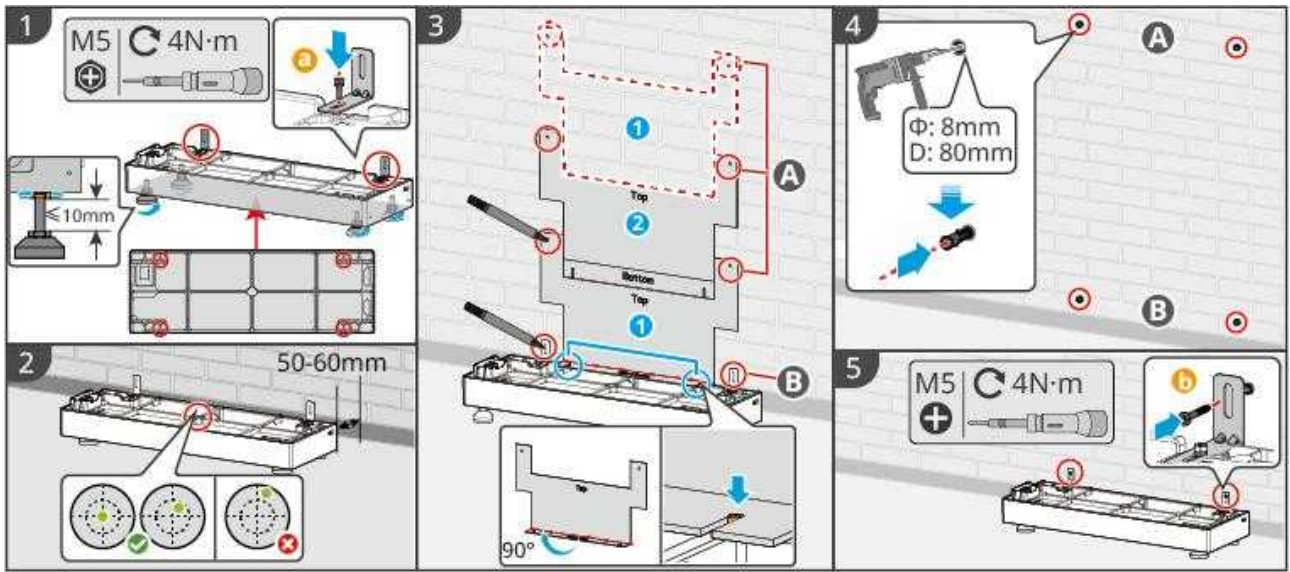

ESA20INT0004

Installing the Battery System and Inverter

Step 1: dismantle Inverter or the protective cover on the bottom blind-mate connector of Battery.

Step 2: Installation Handle (optional), stack Battery onto Base.

If Installation exceeds 3 pieces of Battery, use lifting tools.

Step 3: Tighten the screw between Battery and Base or between Battery and Battery.

If multiple Battery are required for Installation, please repeat **Step 1**、**Step 2** Complete all Battery Installation, Battery stacking quantities follow the "[2.2.1. System Overall Configuration Description \(Page 38\)](#)".

Step 4: The topmost Battery is secured to the wall using locking bracket.

Step 5: Installing the Inverter or Battery Protective cover P.

- Integrated Installation: Lift the Inverter, align it, and stack it on top of the Battery, then fasten the screw between the Inverter and Battery. If the system is configured as an integrated unit, the Installation is now complete.
- Split-type expansion: Repeat the steps of Installing the Battery System. After completing the electrical connections, place the Battery Protective cover P on top of the Battery and secure the side screw.

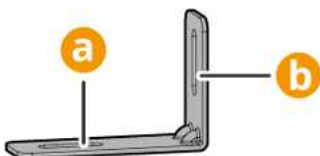

a: Fixed surface with PACK; b: Fixed surface with wall.

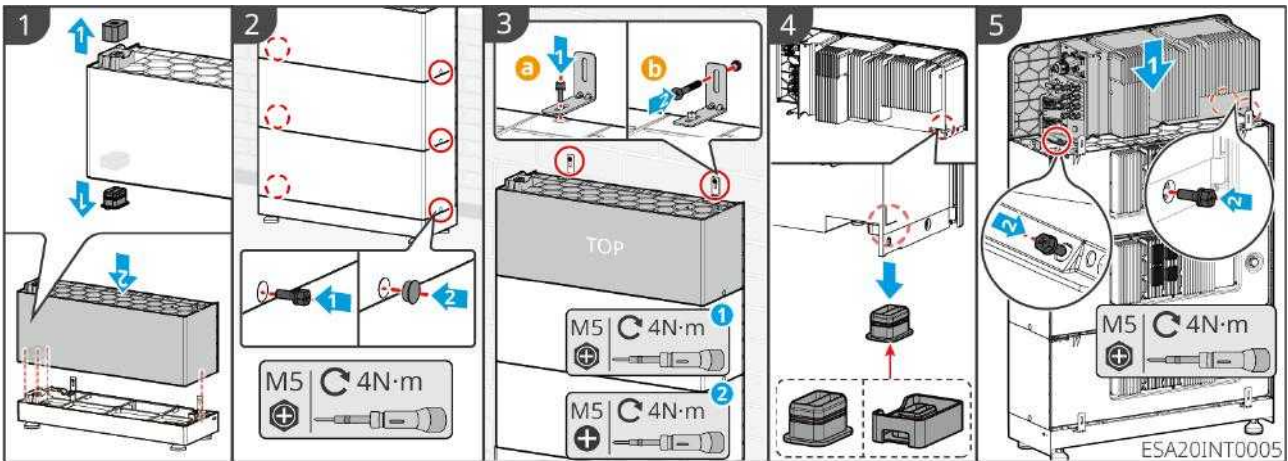

4.4 Installing the Smart Meter

⚠ WARNING

In areas at risk of lightning, if the meter cable exceeds 10m and the cables are not wired with grounded metal conduits, you are recommended to use an external lightning protection device.

GMK110

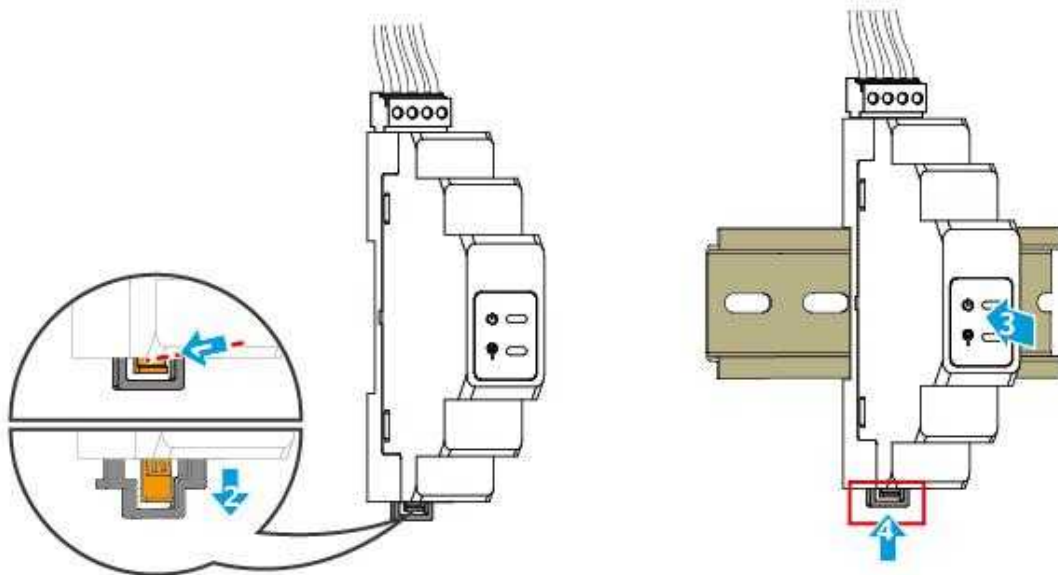

GM330

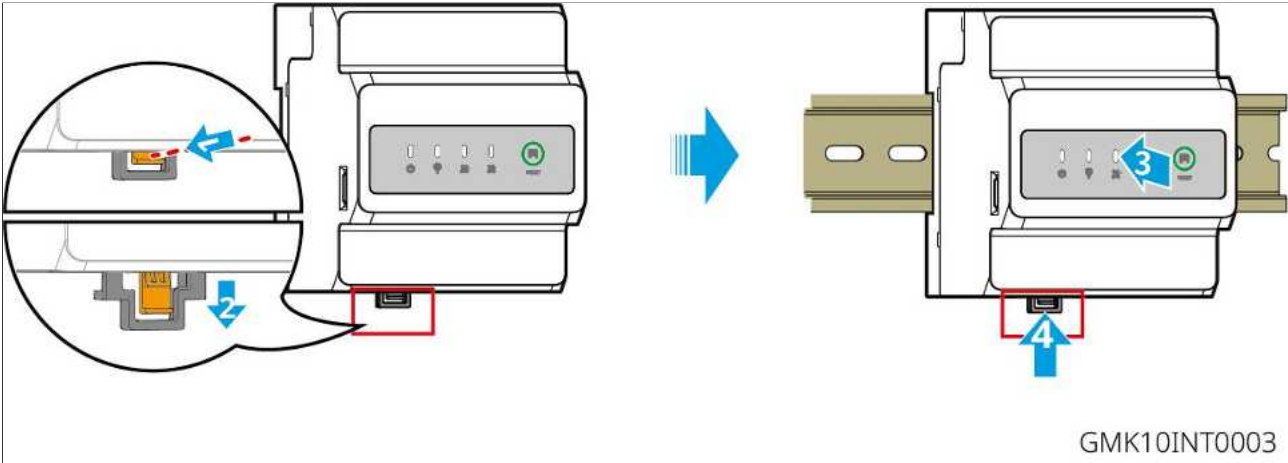

5 System Wirings

DANGER

- The installation, routing, and connection of cables must comply with local laws, regulations, and standard requirements.
- All operations during electrical connections, as well as the specifications of cables and components used, must comply with local laws and regulations.
- Before performing electrical connections, please disconnect the DC switch and AC output switch of the device to ensure it is powered off. Live operation is strictly prohibited, otherwise it may lead to DANGER such as electric shock.
- Cables of the same type should be bundled together and arranged separately from different types of cables. Intertwining or cross-arrangement is prohibited.
- If the cable is subjected to excessive tension, it may lead to poor connections. When wiring, please leave a certain length of cable before connecting to the inverter terminal ports.
- When crimping terminals, ensure that the conductor part of the cable is in full contact with the terminal. Do not crimp the cable insulation together with the terminal, otherwise it may cause the device to fail to operate, or after operation, due to unreliable connections leading to heating and other conditions that damage the inverter terminal block.
- The inverter is not tested to AS/NZS 4777.2:2020 for combinations and/or multiple phase inverter combinations so that combinations should not be used.
- For unused cable holes and ports (including communication ports), please use the dedicated terminals or plugs provided in the accessory box to reliably seal them. Otherwise, it may cause the following risks:
 - DANGER of electric shock: Open electrical ports may cause direct contact with live parts, leading to electric shock accidents.
 - Failure of protection: Open ports may allow dust, moisture, or foreign objects to intrude, which may lead to short circuits, fires, or equipment failures.

NOTICE

- When performing electrical connections, wear personal protective equipment such as safety shoes, protective gloves, and insulated gloves as required.
- Only qualified personnel are permitted to perform electrical connection-related operations.
- The cable colors in the diagrams are for reference only; specific cable specifications must comply with local regulations.

5.1 System Wiring Electrical Block Diagram

NOTICE

- Depending on regional regulatory requirements, the wiring methods for the N and PE lines at the inverter's ON-GRID and BACK-UP ports differ. Please follow local regulations.
- The inverter has a built-in meter and can be directly connected to a CT for use. The CT network cable included in the shipment is 10 meters. If a longer distance is required, you can extend it up to 30 meters using shielded network cable of CAT5E or higher grade.
- CT accuracy will decrease when the connection length to the inverter exceeds 30m. For higher accuracy requirements, an external smart meter can be connected.
- The inverter's ON-GRID AC port has a built-in relay. When the inverter is in off-grid mode, the built-in ON-GRID relay is open; when the inverter is in grid-tied operation mode, the built-in ON-GRID relay is closed.
- When the inverter is powered on, the BACK-UP AC port is live. If maintenance is required on the BACK-UP Loads, please power down the inverter to avoid electric shock.
- In a whole-house backup scenario, if the total power of connected loads exceeds the inverter's rated power, the inverter will stop output due to overload protection after a grid outage. In this case, please turn off some non-essential loads to ensure the total load power is less than the inverter's power.

N and PE wires are connected together in the distribution box.

NOTICE

- To maintain neutral integrity, the neutral wires on the grid-connected side and off-grid side must be connected together; otherwise, the off-grid function cannot be used normally.
- The following diagram is a schematic of the grid system for regions such as Australia and New Zealand:

Whole House Backup Power

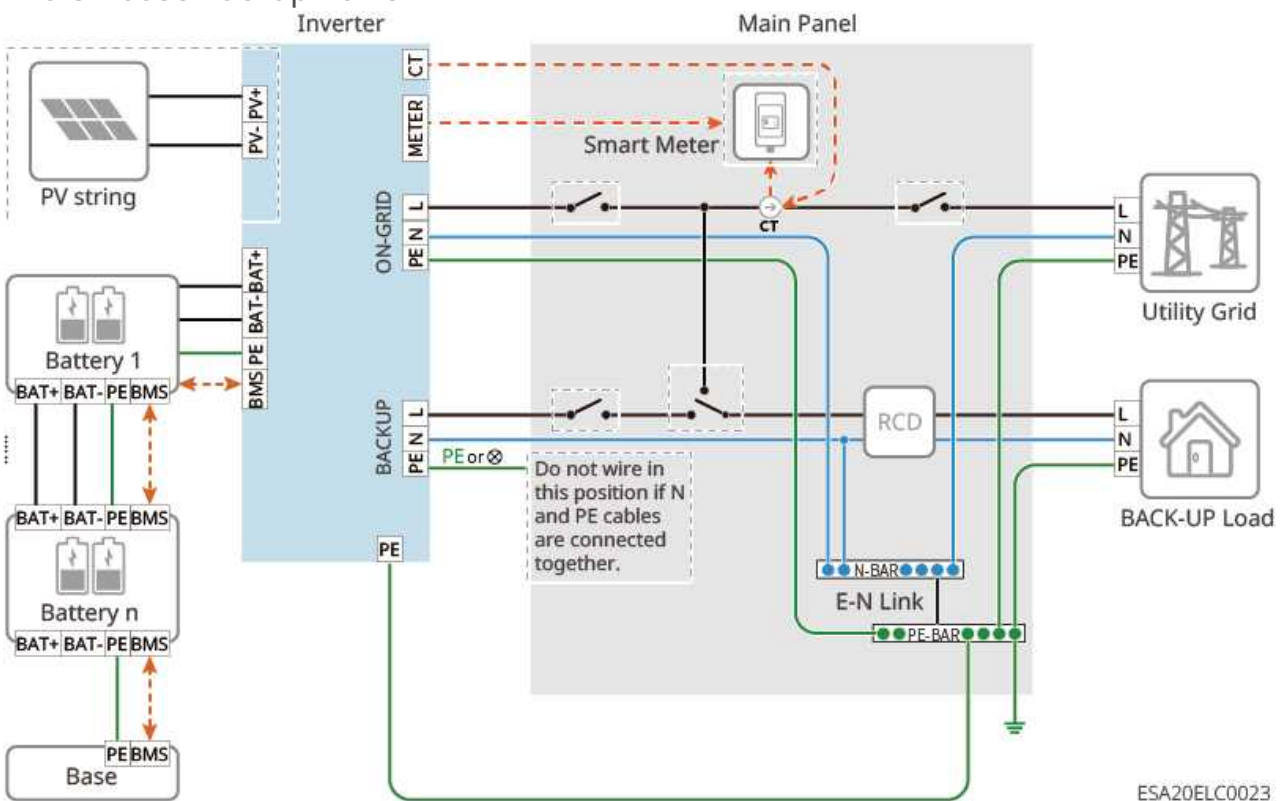

Partial Backup Power

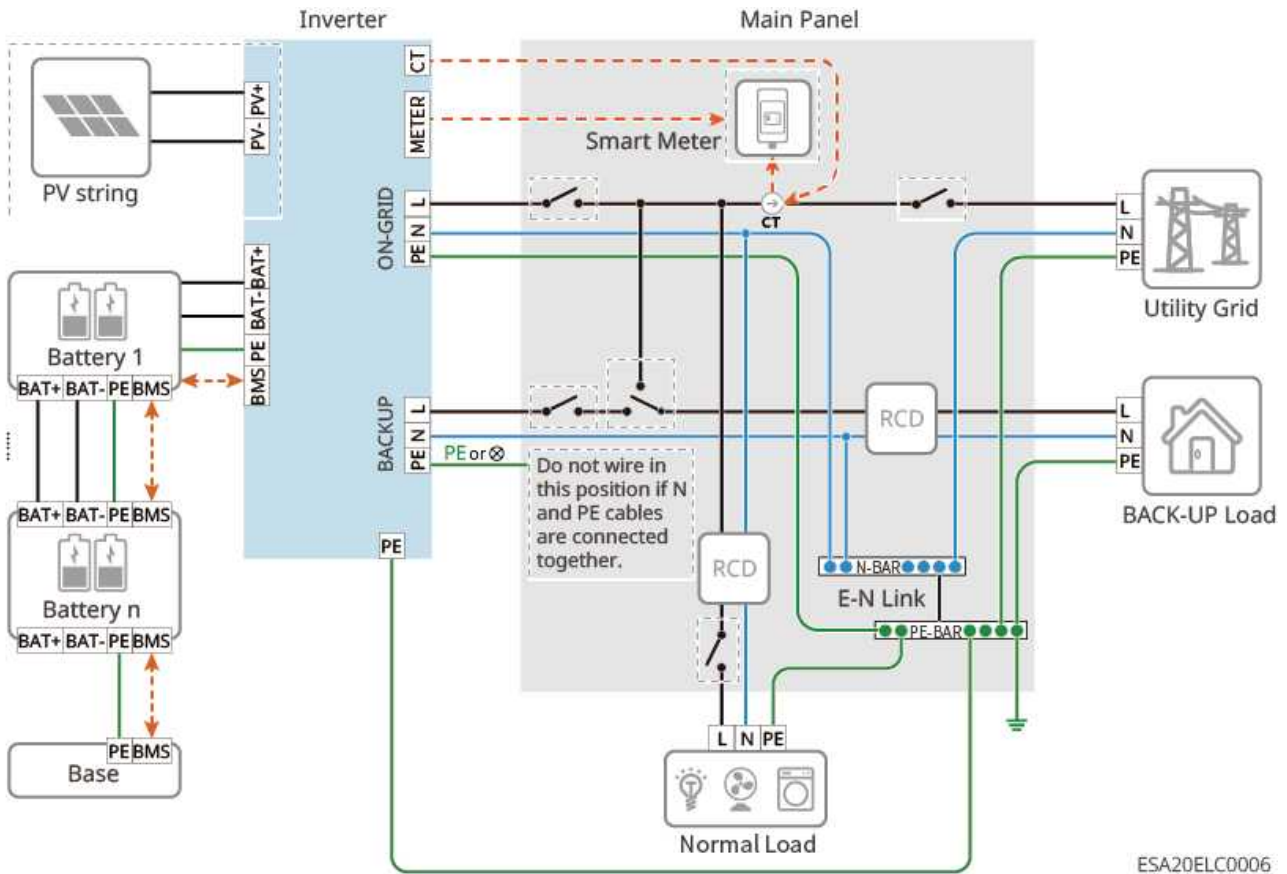

N and PE wires are separated in the distribution box.

NOTICE

- Ensure the protective grounding wire for the BACK-UP is correctly and securely connected. Otherwise, the BACK-UP function may malfunction in the event of a grid fault.
- The following wiring method applies to regions other than Australia, New Zealand, etc.:

Whole House Backup Power

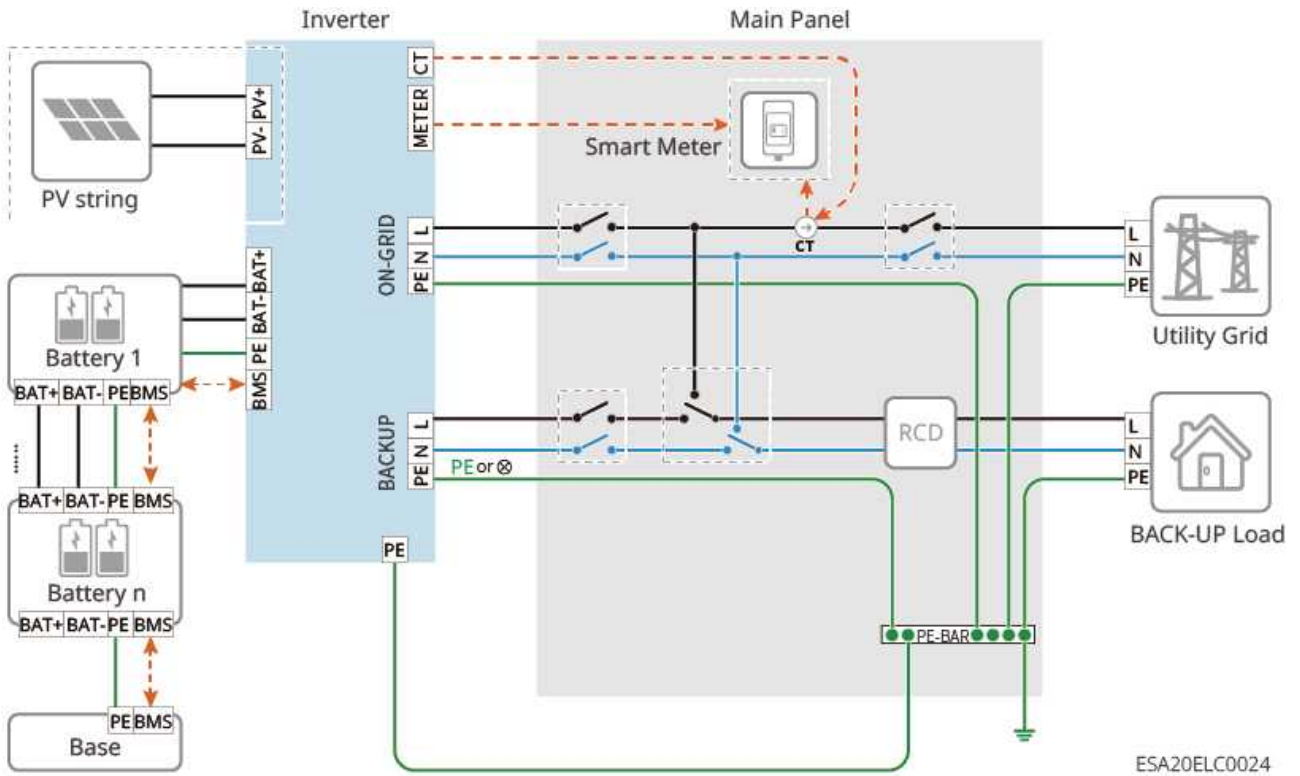

Partial Backup Power

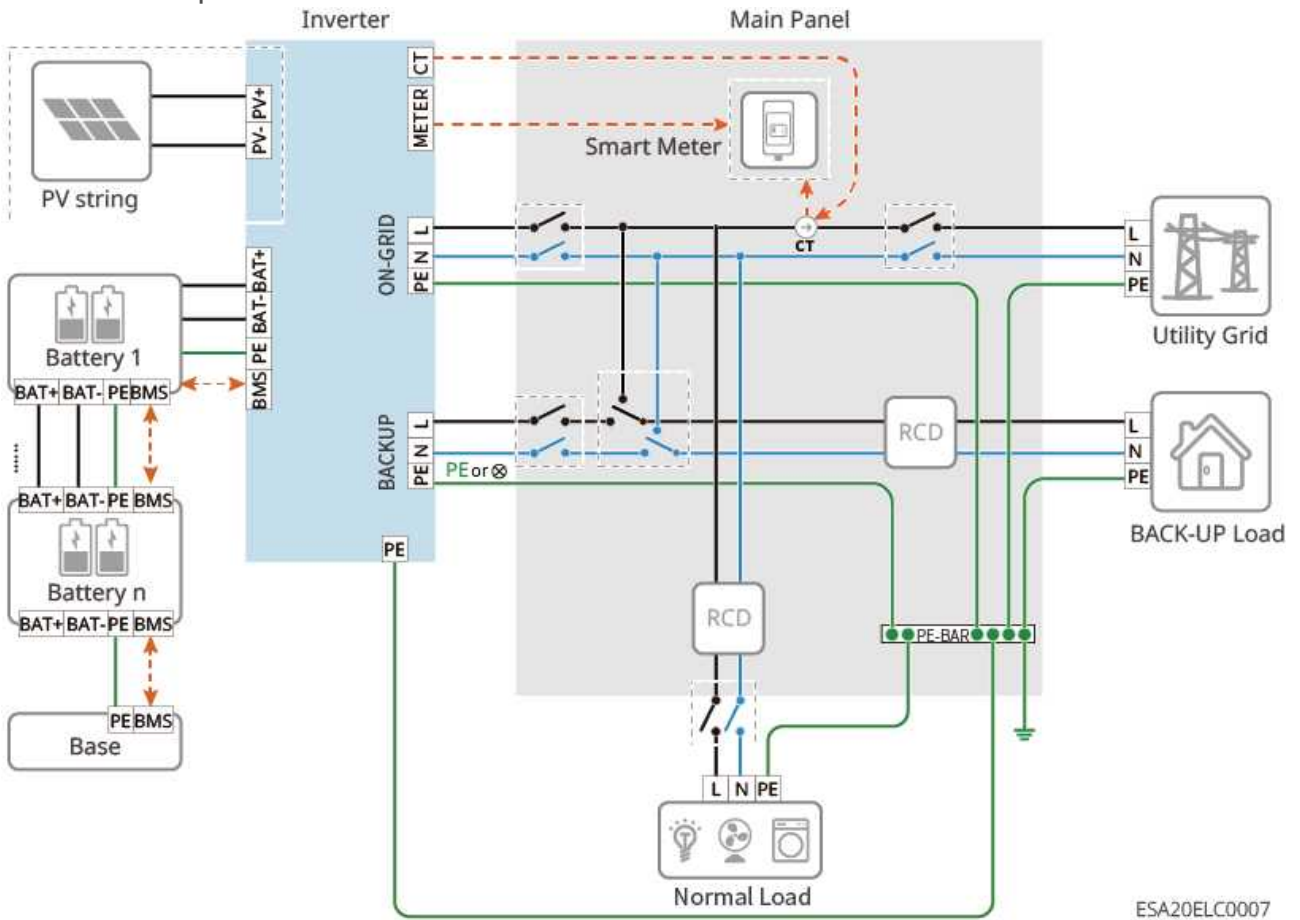

5.2 Detailed System Wiring Diagram

When all loads in a photovoltaic system are unable to consume the electricity generated by the system, the remaining electricity is fed into the grid. At this point, a smart meter or a CT can be used in conjunction to monitor the system's power generation and control the amount of electricity fed into the grid.

- Connecting a smart meter enables the functions of export power limit and load monitoring.
- After connecting a smart meter, please enable the export power limit function via the SolarGo App.

In the single-unit system wiring diagram, only some models of equipment are used for wiring demonstration. Please perform wiring according to the actual equipment in use and refer to the corresponding wiring guide chapter.

Notice

- When implementing load monitoring functions in microgrids and coupled scenarios, a dual-meter network must be used.
 - Smart meter 1 or built-in electric meter monitors the grid connection power of the system.
 - Smart meter 2 monitors the power generation of the on-grid inverter.
 - By integrating the data from Meter 1 and Meter 2, the monitoring platform can realize real-time monitoring of the load's power consumption.
- In microgrid scenarios, only one energy storage inverter is supported for use in the system.
- If export power limit is required for the grid-connected inverter, please connect a separate device such as a smart meter or CT.
- Microgrid scenarios and coupled scenarios are paired with dual electricity meters, and the wiring methods for the meters are consistent.
- When not using integrated smart meter, do not connect the CT port of the inverter.
- Manual conversion switches are optional. Please choose whether to install them based on the actual usage scenario. If you have your own ATS or STS switch, this switch must have an interlock function.

Dual electricity meter pairing scenario

Smart Meter 1 (Grid end)	Smart Meter 2 (AC side of on-grid Inverter)
Built-in Meter (Single inverter)	GMK110
Built-in Meter (Single inverter)	GM330
GMK110	GMK110
GM330	GM330
GMK110	GM330
GM330	GMK110

5.2.1 Detailed System Wiring Diagram for Single Inverter

General Scenario

With built-in smart meter scenarios

Connection to a generator is not supported.

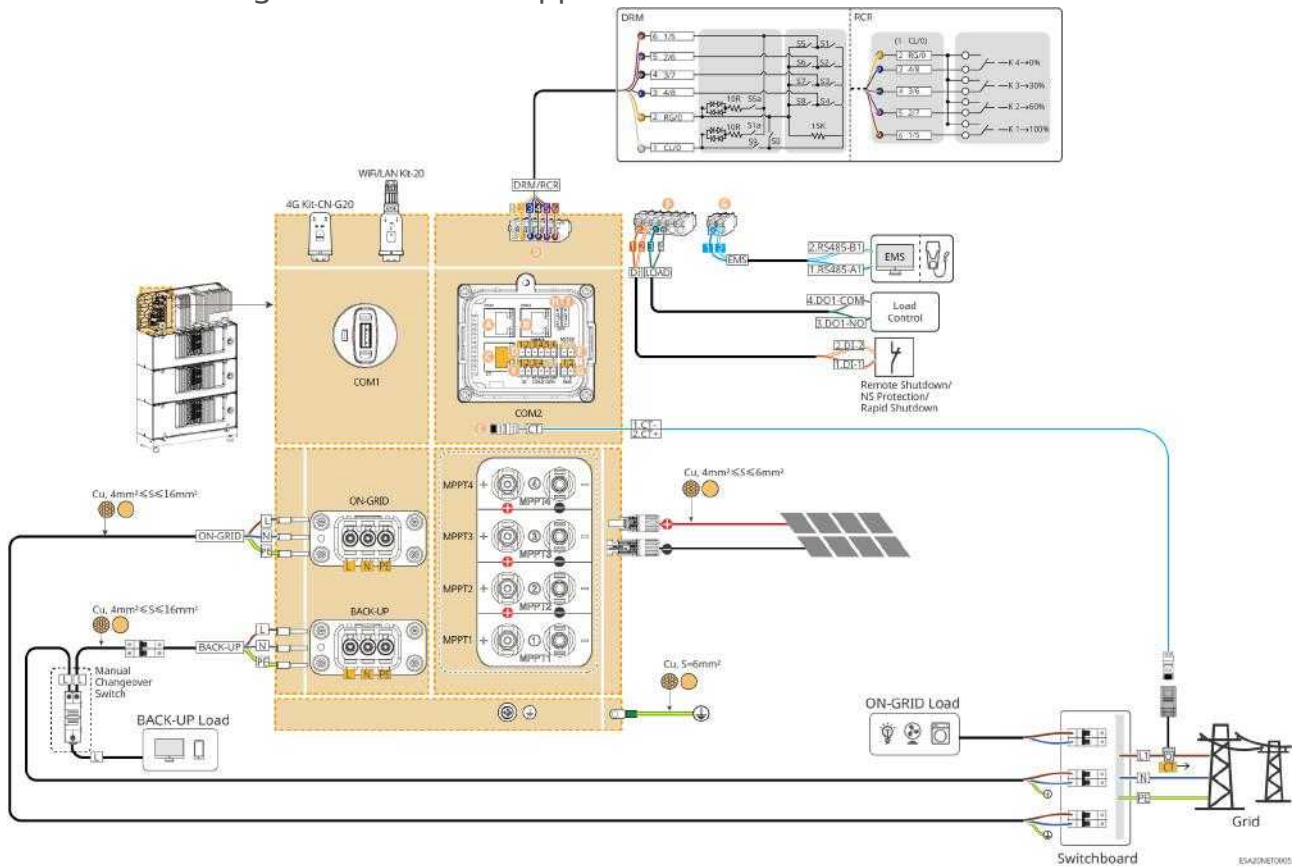

With GMK110 Smart Meter

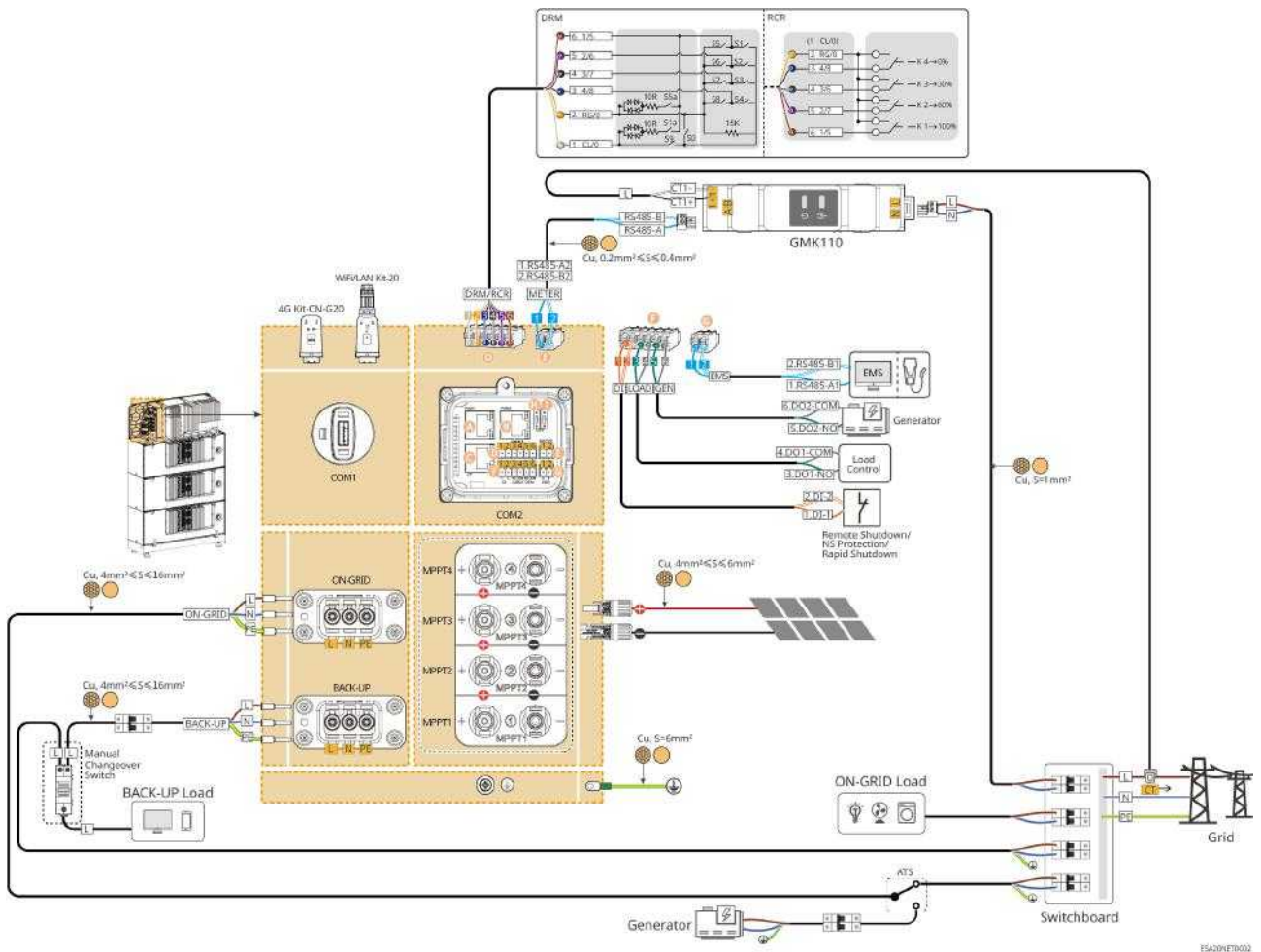

With GM330 Smart Meter

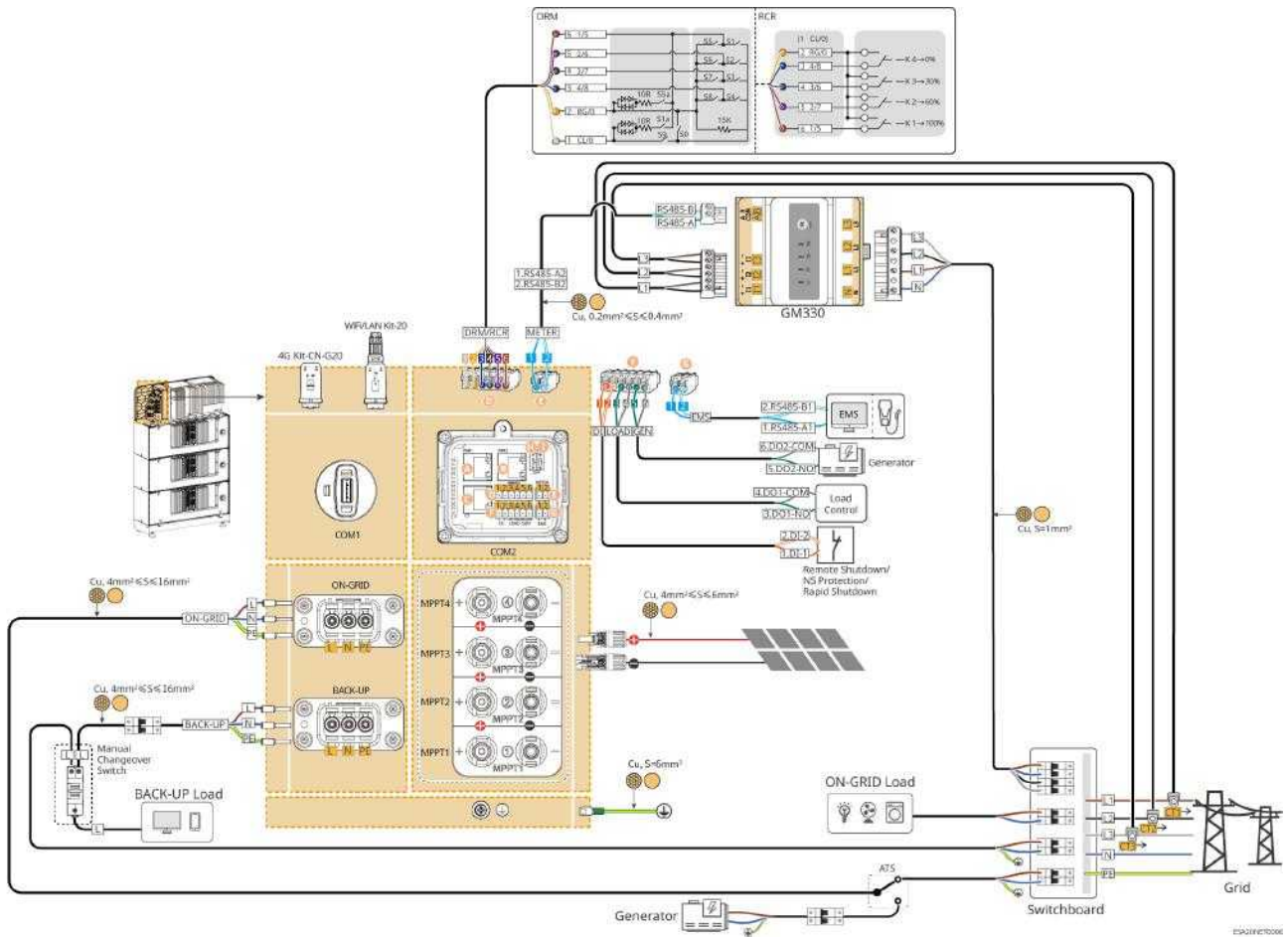

Microgrid Scenario

- In microgrid scenarios, connection to a generator is not supported.
- Manual conversion switches are optional. Please choose whether to install them based on the actual usage scenario.

Built-in Smart Meter+GM330 Smart Meter Networking Diagram

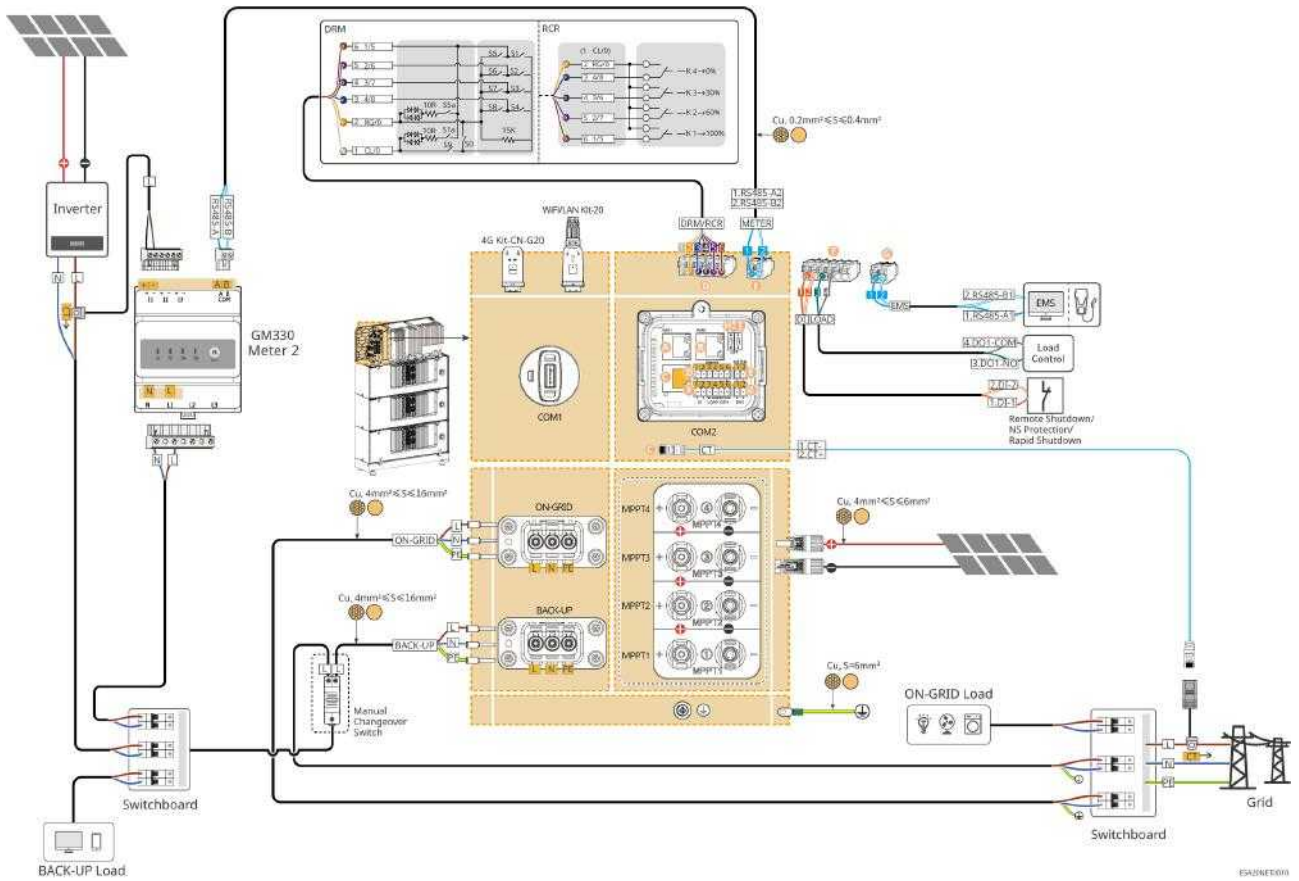

GMK110+GMK110 Networking Diagram

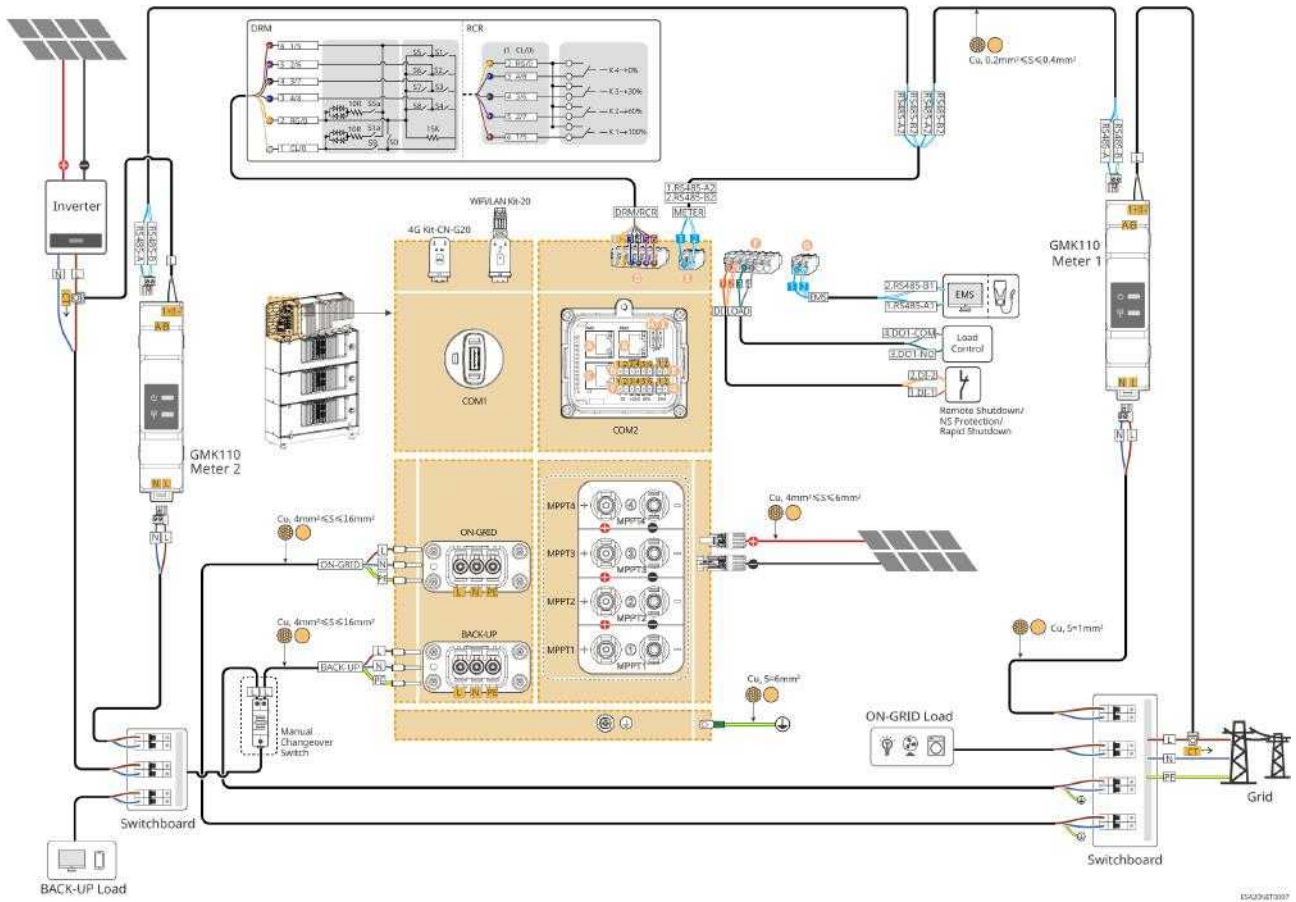

Microgrid Scenario. On-grid Inverter Export Power Limit Networking Diagram

If export power limit is required for the on-grid inverter, please connect a separate device such as a smart meter or CT.

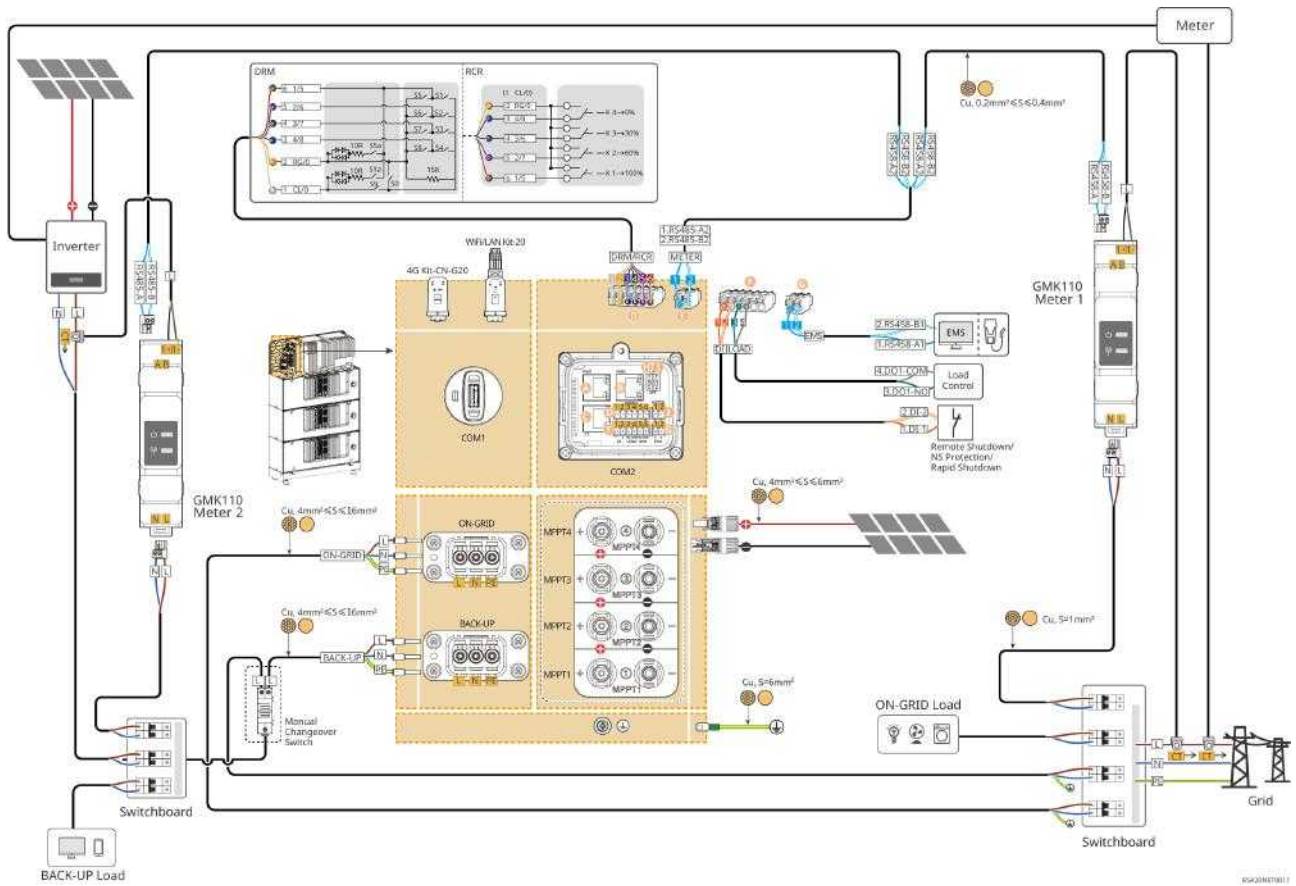

Coupled Scenario. Dual Smart Meter Networking Diagram

- Manual conversion switches are optional. Please choose whether to install them based on the actual usage scenario.
- Connection to a generator is not supported for scenario with inverter using built-in meter.

Built-in Smart Meter+GMK110 Smart Meter Networking Diagram

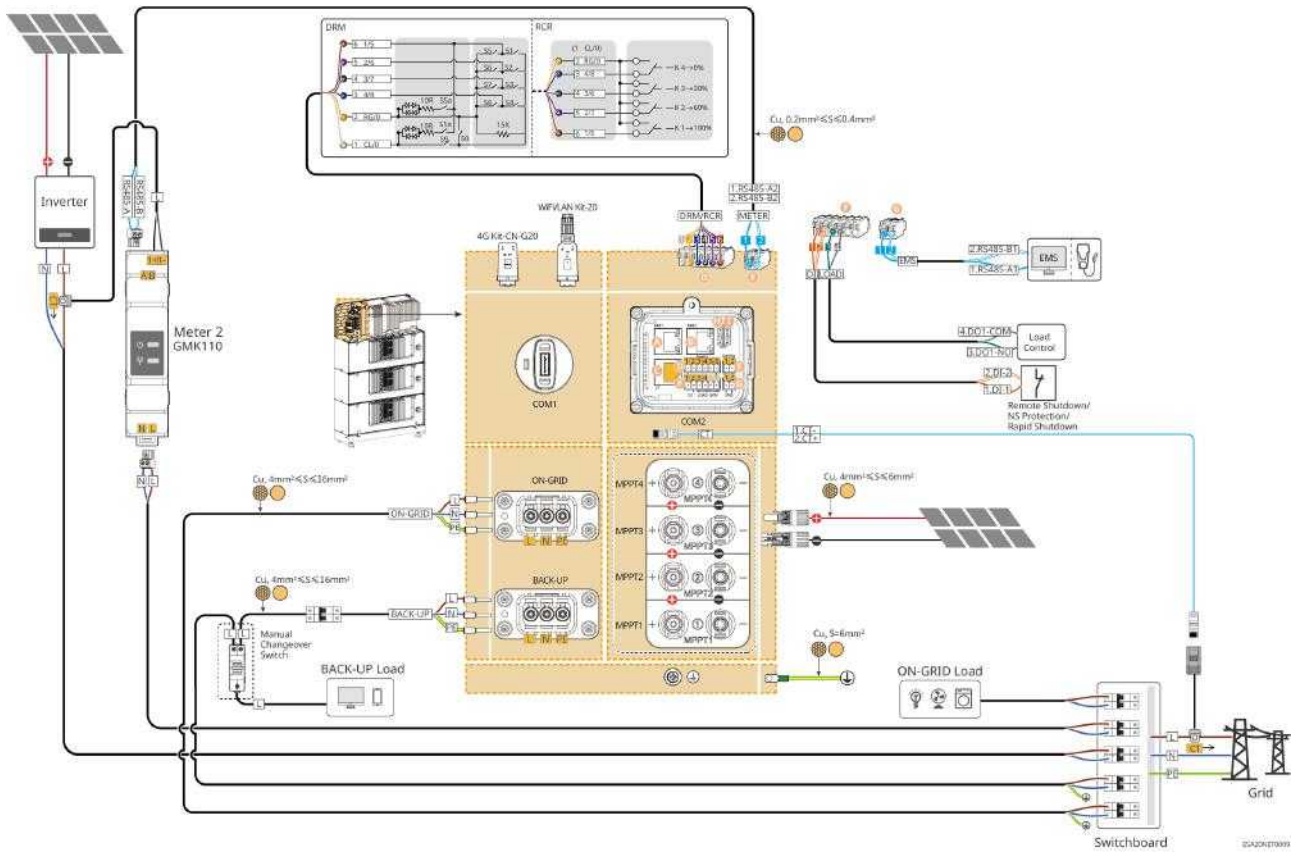

GM330+GM330 Networking Diagram

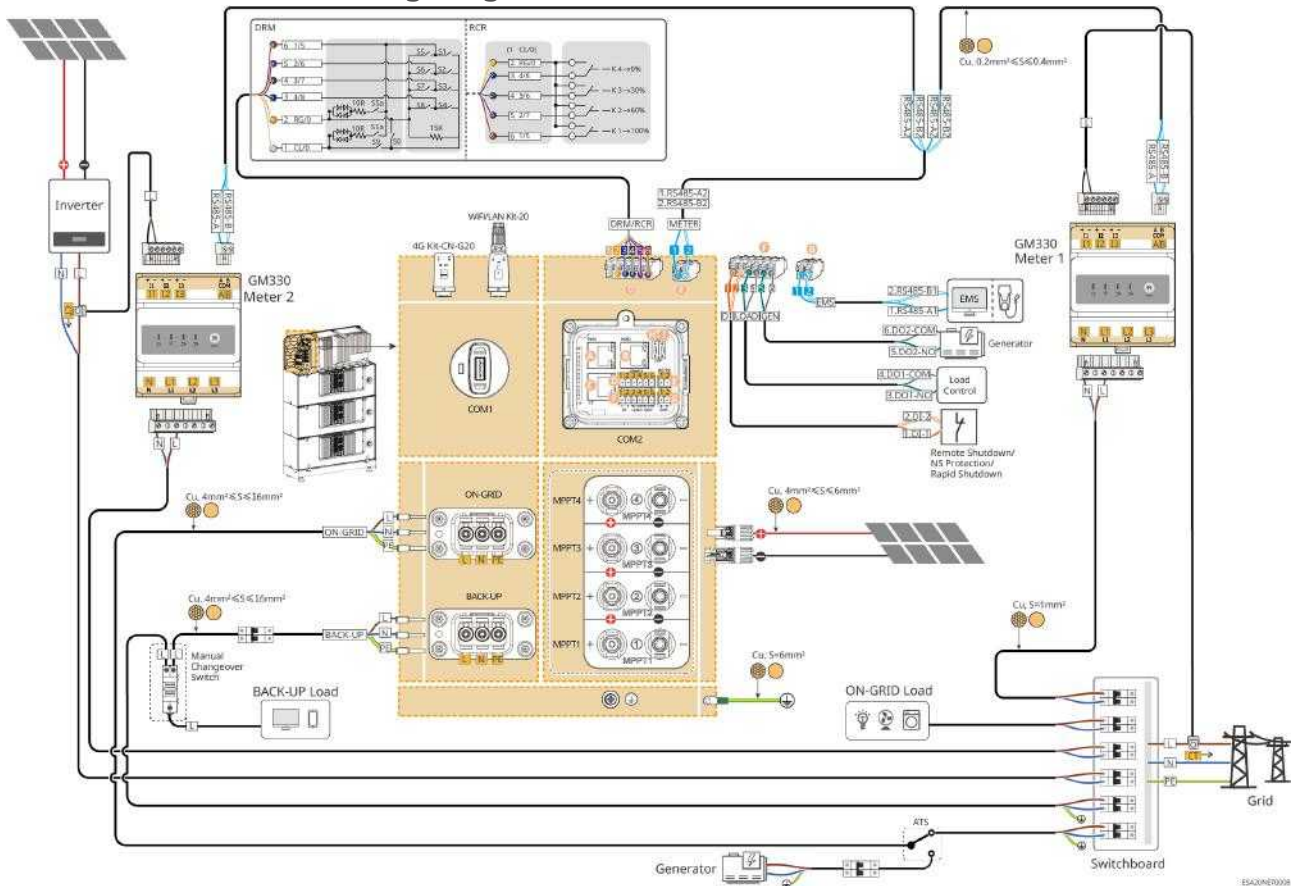

Coupled Scenario. On-grid Inverter export power limit Networking Diagram

In the coupled scenario, if export power limit is required for the on-grid inverter, please connect a separate device such as a smart meter or CT.

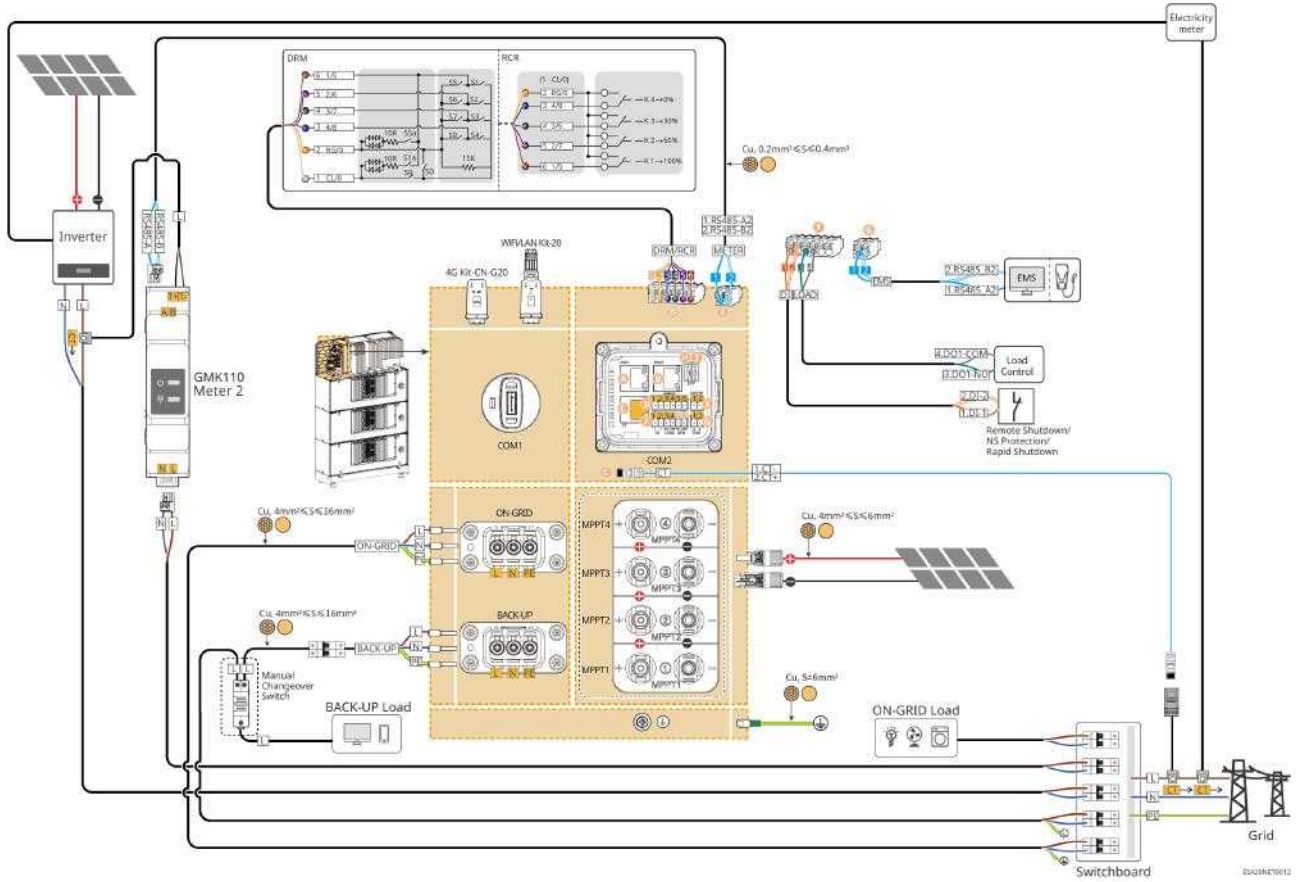

5.2.2 Detailed System Wiring Diagram for Parallel System

NOTICE

- If devices such as DRED equipment, RCR equipment, remote shutdown equipment, NS Protection, and SG Ready heat pumps need to be connected in the system, please connect them to the master inverter.
- Remote shutdown/NS Protection Function: please connect the communication cable to the master inverter. Rapid shutdown function: please connect the communication cable to each inverter respectively. If the rapid shutdown function and remote shutdown/NS protection function need to be used at the same time, please contact the after-sales service center.
- Please use a GM330 smart meter if over 2 inverters are paralleled.
- The parallel system does not support generator connection.
- In a parallel system, if you need to switch off any port breaker of an inverter, please simultaneously switch off the other port breakers of the same inverter; otherwise, system malfunctions may occur.
- The following diagram mainly introduces parallel connections. For other port connections, refer to the single system.

In parallel scenarios, the inverter connected to the smart meter is considered as the master inverter, while all the others are slavery inverters.

The master inverter must be set as the master unit through the parallel system settings in the **"SolarGo App"**. For specific settings, please refer to [9.2.6."Setting Up the RS485 Parallel System"\(Page 160\)](#).

General Scenarios

With GMK110 scenarios

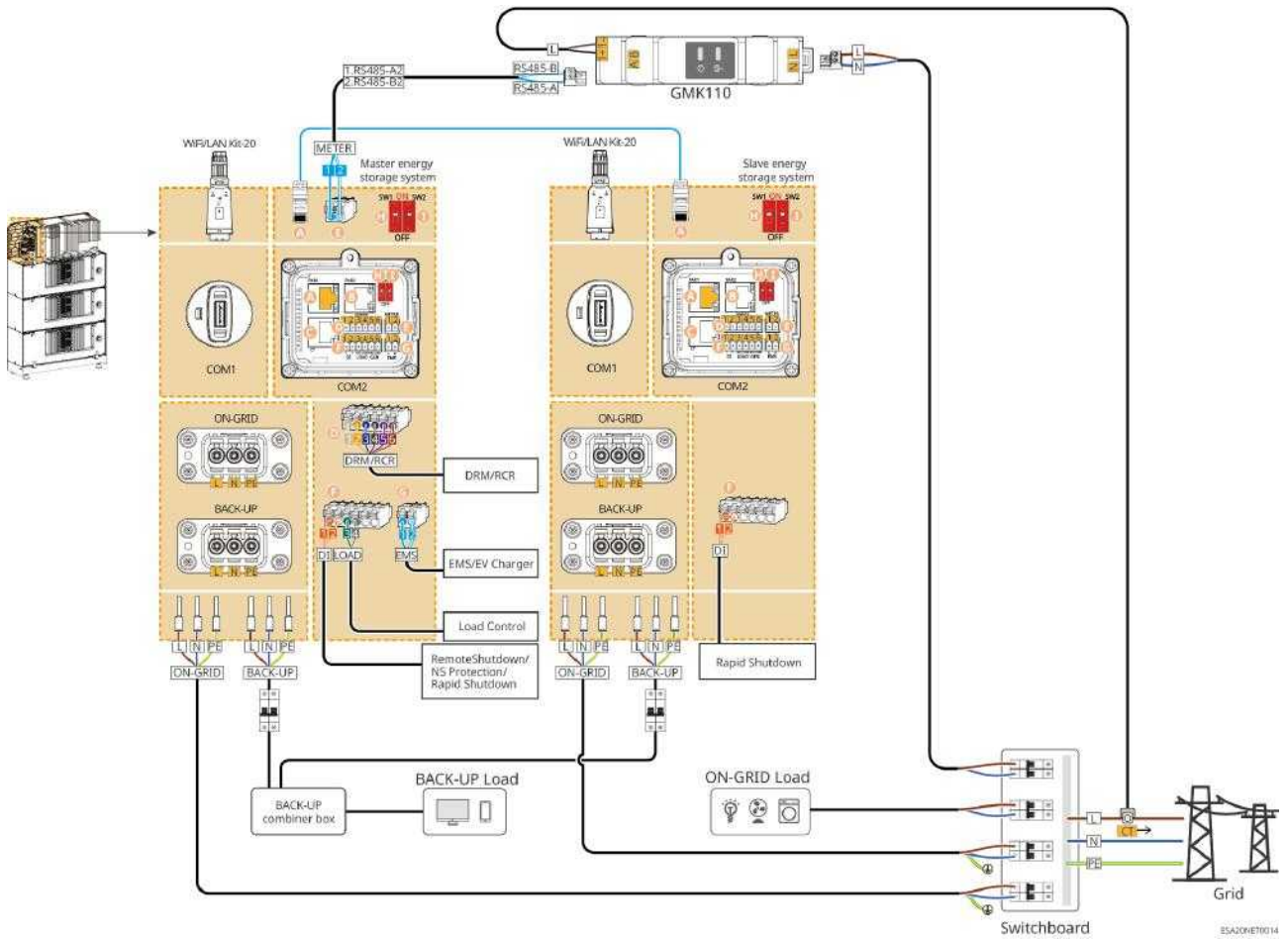

With GM330 scenarios

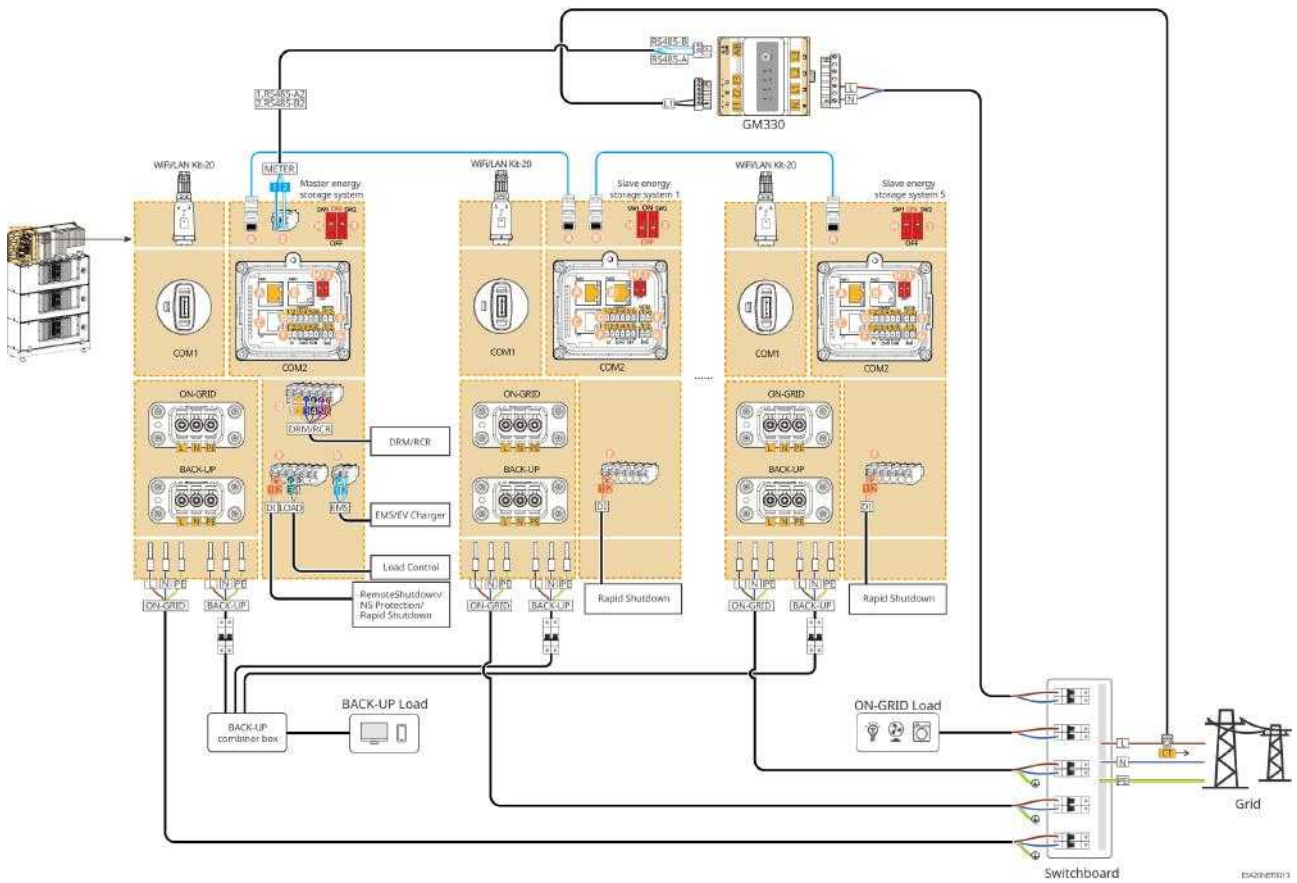

Coupled Scenarios
GM330+GM330 Networking Diagram

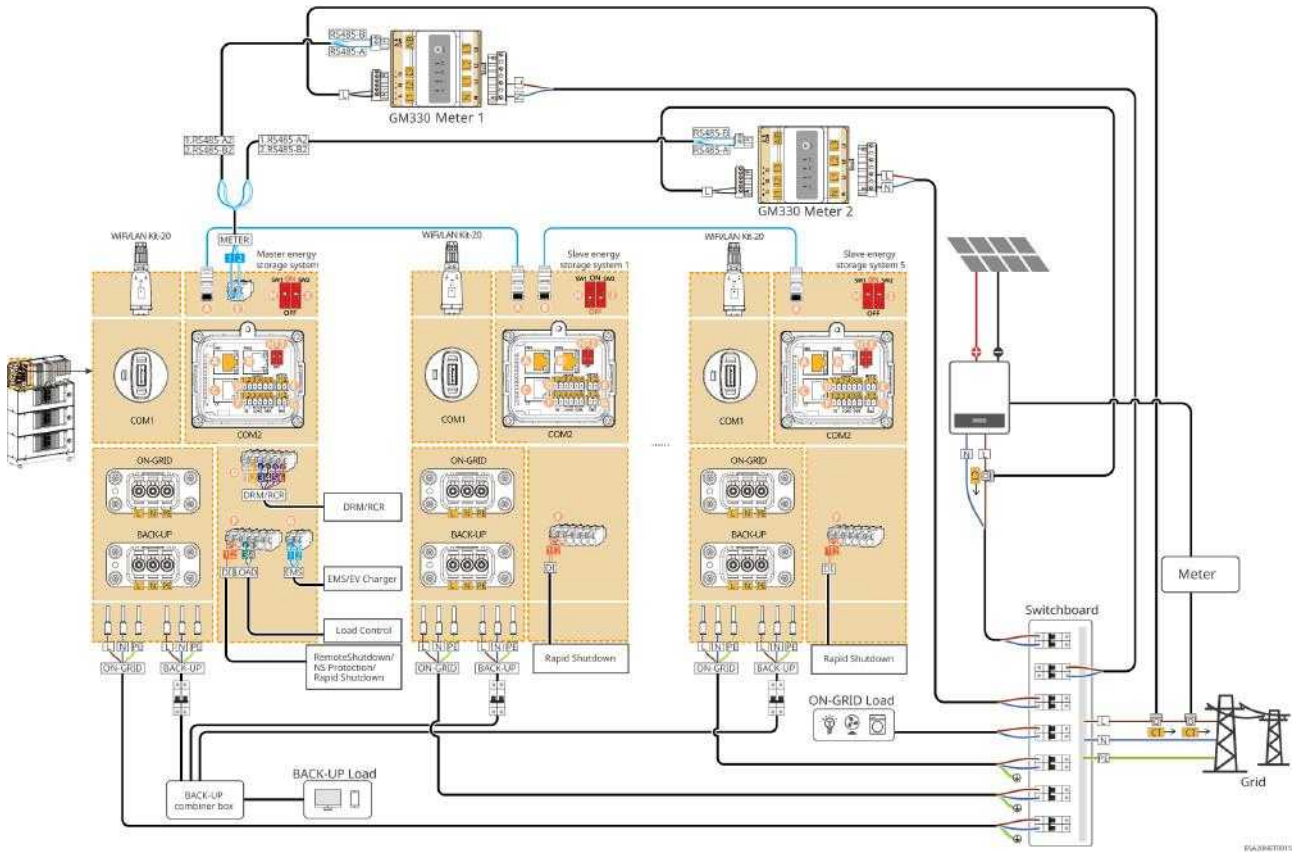

In the coupled system scenarios, the paralleling wiring method for the configuration with GMK110 can refer to the scenario of configuring GMK110 in the general paralleling scenario; the wiring method for the grid-connected inverter can refer to the single-unit coupling scenario for wiring.

5.3 Preparing Materials



- Do not connect loads between the inverter and the AC switch directly connected to the inverter.
- Install one AC output circuit breaker for each inverter. Multiple inverters cannot share one AC circuit breaker.
- An AC circuit breaker shall be installed on the AC side to make sure that the inverter can safely disconnect the grid when an exception happens. Select the appropriate AC circuit breaker in compliance with local laws and regulations.
- When the inverter is powered on, the BACK-UP AC port is charged. Power off the inverter first if maintenance is required on the BACK-UP loads. Otherwise, it may cause electric shock.
- For cables used in the same system, it is recommended that the conductor material, cross sectional area, length, etc. of the following cable should be consistent.
 - The AC cable for BACK-UP port of each inverter
 - The AC cable for ON-GRID port of each inverter
- In single inverter scenario, the inverter supports connection to a generator via an ATS switch, enabling switching between grid and generator power supply. The ATS switch is connected to the power grid by default.

5.3.1 Preparing Breakers

No.	breaker	Recommended Specifications	Acquisition Method	Remarks
1	ON-GRID breaker BACK-UP breaker	<p>For partial backup scenarios, the recommendations are as follows:</p> <ul style="list-style-type: none"> • Rated voltage $\geq 230V_{ac}$ • Rated current requirements are as follows: <ul style="list-style-type: none"> ◦ GW3K-EHA-G20: 20A ◦ GW3.6K-EHA-G20: 20A ◦ GW5K-EHA-G20: 32A ◦ GW6K-EHA-G20: 40A 	Self-provided	During actual selection, you can also choose a breaker that meets local installation regulations based on the actual operating current.

No.	breaker	Recommended Specifications	Acquisition Method	Remarks
		<ul style="list-style-type: none"> ◦ GW8K-EHA-G20: 50A ◦ GW9.999K-EHA-G20: 63A ◦ GW10K-EHA-G20: 63A ◦ GW3K-BHA-G20: 20A ◦ GW3.6K-BHA-G20: 20A ◦ GW5K-BHA-G20: 32A ◦ GW6K-BHA-G20: 40A ◦ GW8K-BHA-G20: 50A ◦ GW9.999K-BHA-G20: 63A ◦ GW10K-BHA-G20: 63A <p>For whole-house backup scenarios, the recommendations are as follows:</p> <ul style="list-style-type: none"> • Rated voltage $\geq 230V_{ac}$ • Rated current requirements are as follows: <ul style="list-style-type: none"> ◦ GW3K-EHA-G20: 40A ◦ GW3.6K-EHA-G20: 40A ◦ GW5K-EHA-G20: 63A ◦ GW6K-EHA-G20: 63A ◦ GW8K-EHA-G20: 63A ◦ GW9.999K-EHA-G20: 63A ◦ GW10K-EHA-G20: 63A ◦ GW3K-BHA-G20: 40A ◦ GW3.6K-BHA-G20: 40A ◦ GW5K-BHA-G20: 63A ◦ GW6K-BHA-G20: 63A 		

No.	breaker	Recommended Specifications	Acquisition Method	Remarks
		<ul style="list-style-type: none"> ◦ GW8K-BHA-G20: 63A ◦ GW9.999K-BHA-G20: 63A ◦ GW10K-BHA-G20: 63A <p>Note: If the inverter's BACK-UP port is not used, the ON-GRID breaker can be selected based on the maximum grid-connected current.</p>		
2	ATS switch	The specifications of the ATS switch and ON-GRID breaker for the same model are consistent.	Self-provided	Single unit only
3	RCD (RCD)	RCD device installation and RCD specification selection: It is recommended to connect an A-type RCD with a residual current triggering level $\geq 300\text{mA}$ to the AC output side of the inverter (for inverter capacity $< 30\text{kVA}$, select the residual current operating level as 300mA ; for inverter capacity $\geq 30\text{kVA}$, select the residual current operating level as 10mA/kVA). You can also choose an appropriate RCD specification based on local regulatory requirements.	Self-provided	-
4	(Optional) Manual transfer switch	<ul style="list-style-type: none"> • Rated voltage $\geq 230\text{Vac}$ • Rated current: 63A 	Self-provided or shipped with the inverter (Australia only)	Single unit only

5.3.2 Preparing Cables

No.	Cable	Recommended Specifications	Acquisition Method
1	Inverter Enclosure Protective Ground Wire	<ul style="list-style-type: none"> • Single-core outdoor copper cable • Conductor cross-sectional area: $S=5.2\text{mm}^2\text{-}6\text{mm}^2$ 	Self-provided
2	PV DC Cable	<p>Only for EHA models:</p> <ul style="list-style-type: none"> • Industry-standard outdoor photovoltaic cable • Conductor cross-sectional area: $4\text{mm}^2\text{-}6\text{mm}^2$ • Cable outer diameter: 5.9mm-8.8mm 	Self-provided

No.	Cable	Recommended Specifications	Acquisition Method
3	AC Cable	<ul style="list-style-type: none"> • Inverter AC input/output cable (BACK UP/ON GRID): • Conductor cross-sectional area: 4mm²-16mm² <ul style="list-style-type: none"> ◦ GW3K-EHA-G20, GW3.6K-EHA-G20: 4mm²-6mm² ◦ GW5K-EHA-G20, GW6K-EHA-G20: 6mm²-10mm² ◦ GW8K-EHA-G20, GW9.999K-EHA-G20, GW10K-EHA-G20: 10mm²-16mm² ◦ GW3K-BHA-G20, GW3.6K-BHA-G20: 4mm²-6mm² ◦ GW5K-BHA-G20, GW6K-BHA-G20: 6mm²-10mm² ◦ GW8K-BHA-G20, GW9.999K-BHA-G20, GW10K-BHA-G20: 10mm²-16mm² • Multi-core outdoor copper cable outer diameter: 10mm-21mm 	Self-provided
4	Smart Meter Power Cable	<ul style="list-style-type: none"> • Outdoor copper cable • Conductor cross-sectional area: 1mm² 	Self-provided
5	Meter RS485 Communication Cable	<ul style="list-style-type: none"> • Shielded twisted pair • Conductor cross-sectional area: 0.2mm²-0.4mm² 	Self-provided
6	EMS or Charging Pile RS485 Communication Cable		

No.	Cable	Recommended Specifications	Acquisition Method
7	Remote Shutdown and NS Protection Communication Cable	<ul style="list-style-type: none"> • Shielded cable meeting local standards • Conductor cross-sectional area: 0.2mm²-0.4mm² • Cable outer diameter: 5mm-8mm 	Self-provided
8	Load Control and Generator Control DO Communication Cable		
9	RCR/DRED Signal Cable		
10	CT Communication Cable	standard network cable: CAT 5E and above standard shielded network cable and RJ45 connector	Self-provided
11	Inverter Parallel Communication Cable	<ul style="list-style-type: none"> • RJ45 connector • CAT 5E or higher specification straight-through network cable <ul style="list-style-type: none"> ◦ CAT 5E or CAT 6E recommended length not exceeding 5 meters ◦ CAT 7E recommended length not exceeding 10 meters 	Self-provided

5.4 Connecting the PE cable



- The Protection grounding of the chassis enclosure cannot replace the PE cable of the AC output port. When wiring, ensure that the PE cable at both locations is reliably connected.
- To improve the corrosion resistance of terminal, it is recommended to apply silica gel or paint on the exterior of Grounding terminal for protection after completing the connection of Installation to PE cable.
- When Installation equipment, the PE cable must be Installation first; when dismantle equipment, the PE cable must be dismantle last.
- The grounding is integrated into the blind-mate connector and connected to the Inverter. The system is uniformly grounded through the Inverter, eliminating the need for separate grounding operations on the Battery during Installation. If there is a need for split-type capacity expansion, please separately ground the expanded Battery BANK.

energy storage system Grounding

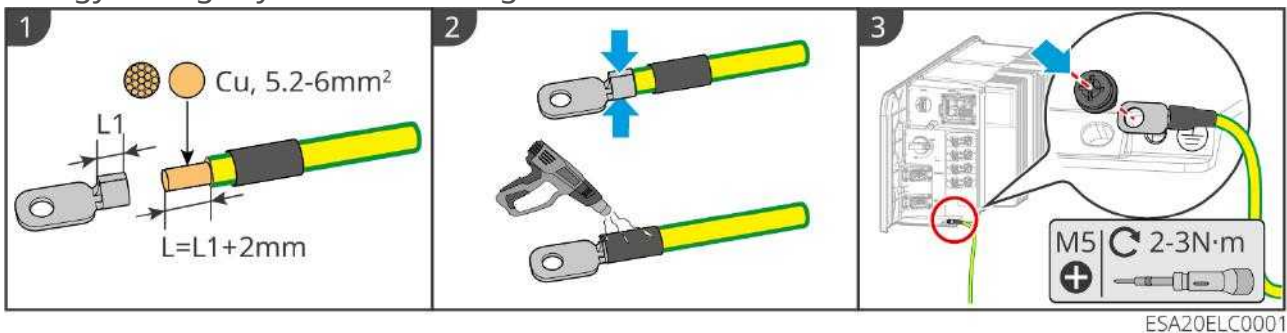

Expansion Battery BANK grounding:

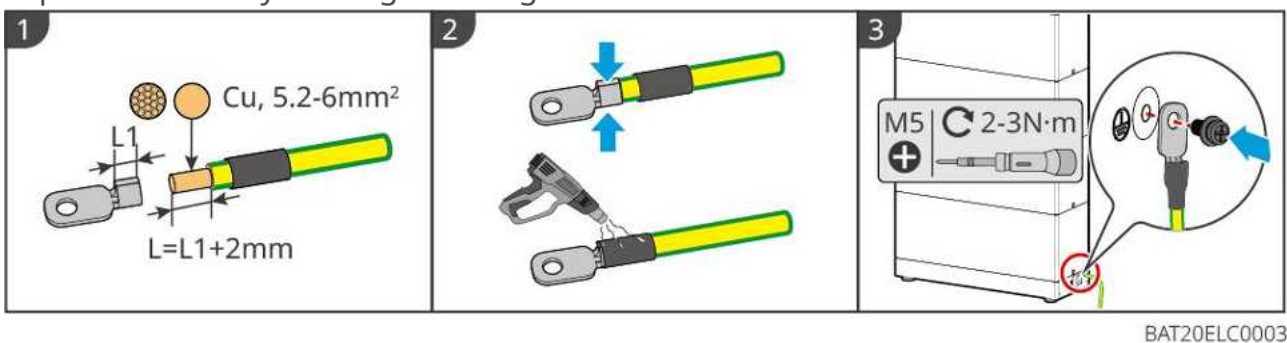

5.5 Connecting the PV Cable

⚠ DANGER

- Do not connect the same PV string to multiple inverters, as this may cause inverter damage.
- Before connecting the PV string to the inverter, confirm the following information. Failure to do so may cause permanent inverter damage, and in severe cases, may lead to fire resulting in personal injury or property loss.
 1. Ensure the maximum short-circuit current and Max.Input Voltage for each MPPT are within the inverter's allowable range.
 2. Ensure the positive pole of the PV string is connected to the inverter's PV+, and the negative pole of the PV string is connected to the inverter's PV-.

 **WARNING**

- PV string output does not support grounding. Before connecting the PV string to the inverter, ensure the minimum insulation resistance to ground of the PV string meets the minimum insulation impedance requirement ($R = \text{Max.Input Voltage} / 30\text{mA}$).
- After completing the DC cable connection, ensure the cable connections are secure and not loose.
- Use a multimeter to measure the positive and negative poles of the DC cable to ensure correct polarity (no reverse connection) and that the voltage is within the allowable range.

NOTICE

- The two PV strings within each MPPT must use the same model, the same number of panels, the same tilt angle, and the same azimuth angle to ensure maximum efficiency.
- Connecting PV cables applies only to EHA models; BHA models do not have PV connection ports.

Type 1:

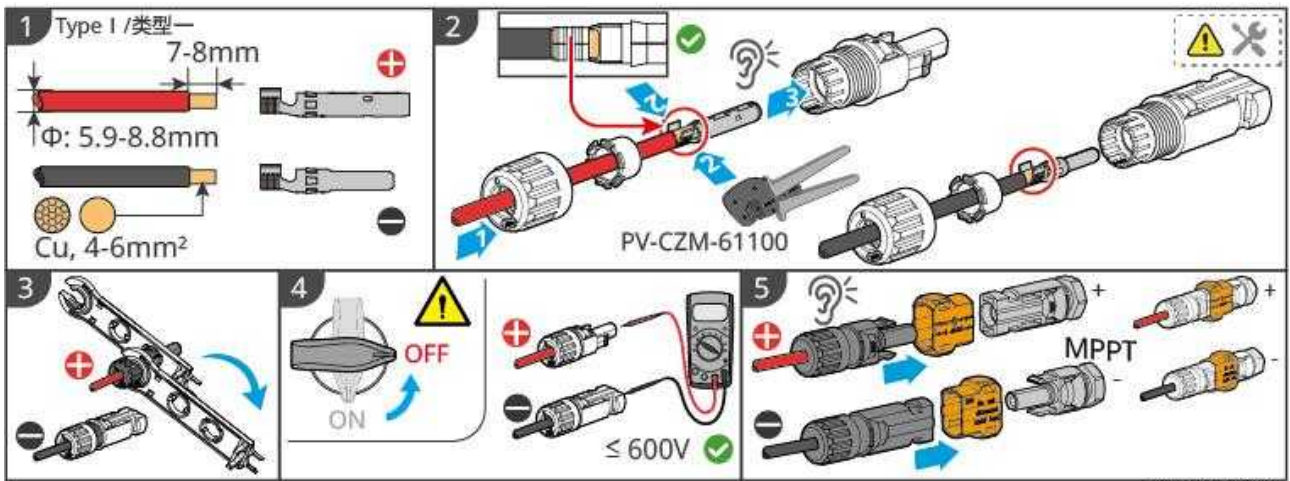

ESA20ELC0004

If you need to disassemble the PV terminal, please refer to the steps below:

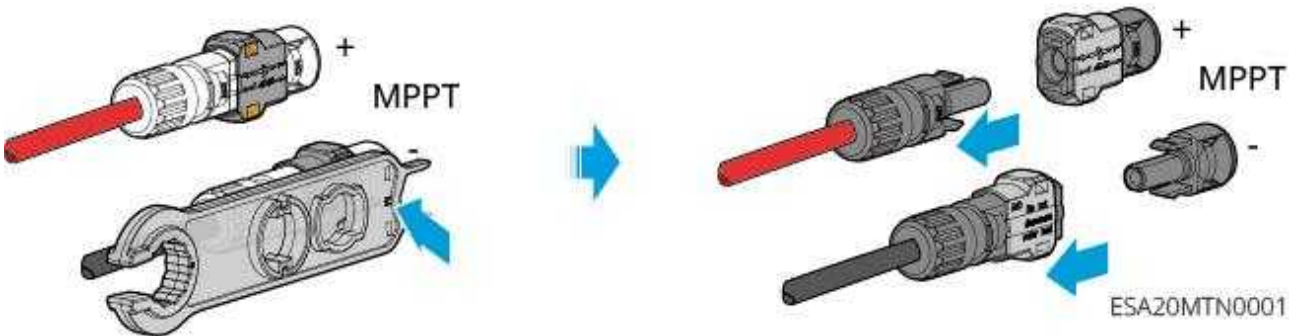

ESA20MTN0001

Type 2:

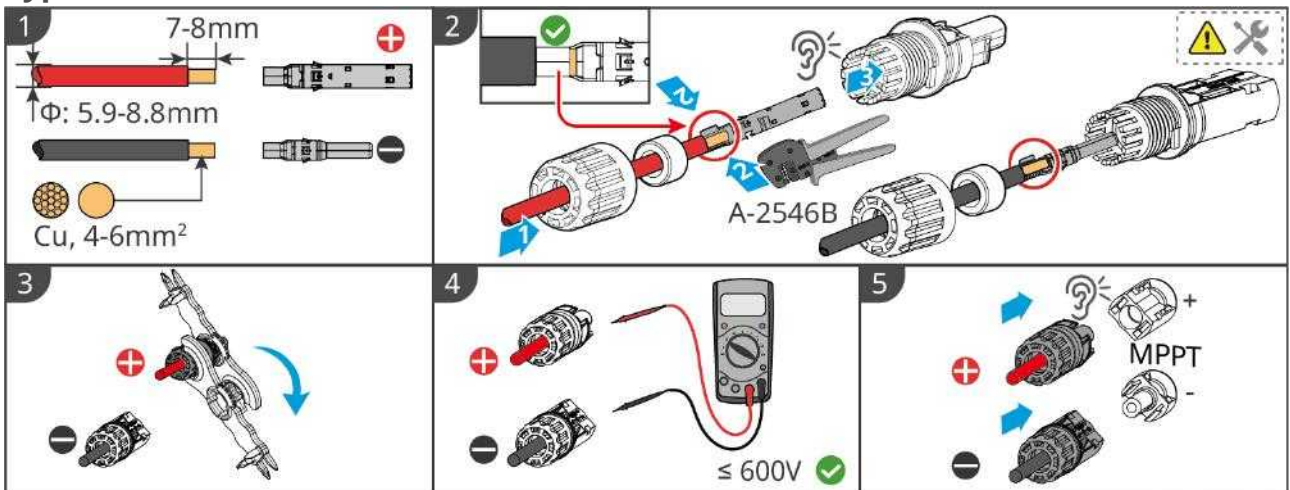

ESA20ELC0013

If you need to disassemble the PV terminal, please refer to the steps below:

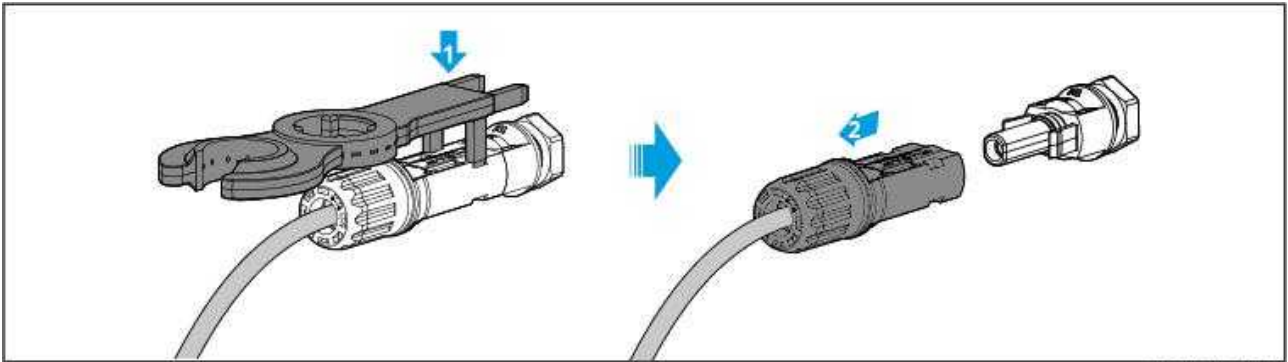

ESA20ELC0014

5.6 Expansion line for connecting Battery



- Do not connect any load between the Inverter and Battery.
- When Connecting the Battery Cable, use insulated tools to prevent accidental electric shock or Battery Short Circuit.
- Please ensure that Battery open-circuit voltage is within the allowable range of Inverter.
- Between Battery and Battery, please configure DC Switch according to local laws and regulations.
- Inverter heat sink surfaces and surrounding areas must remain free of wiring to prevent overheating damage to wire harnesses.

energy storage system Expansion Overview

A1: Base shipped with Inverter

A2: Base with parallel port in Installation

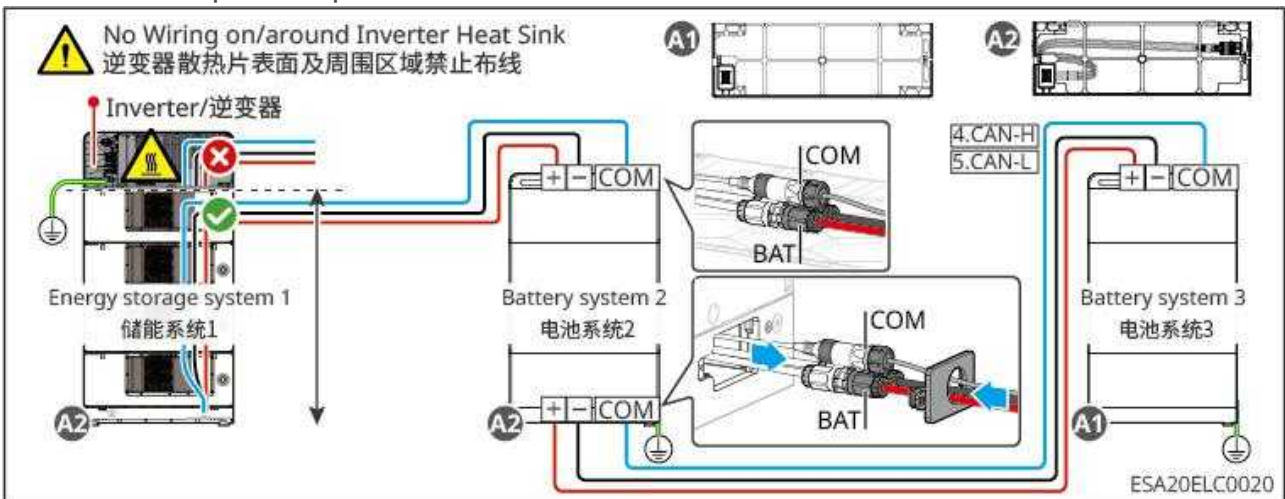

Battery system Expansion Harness Manufacturing Method

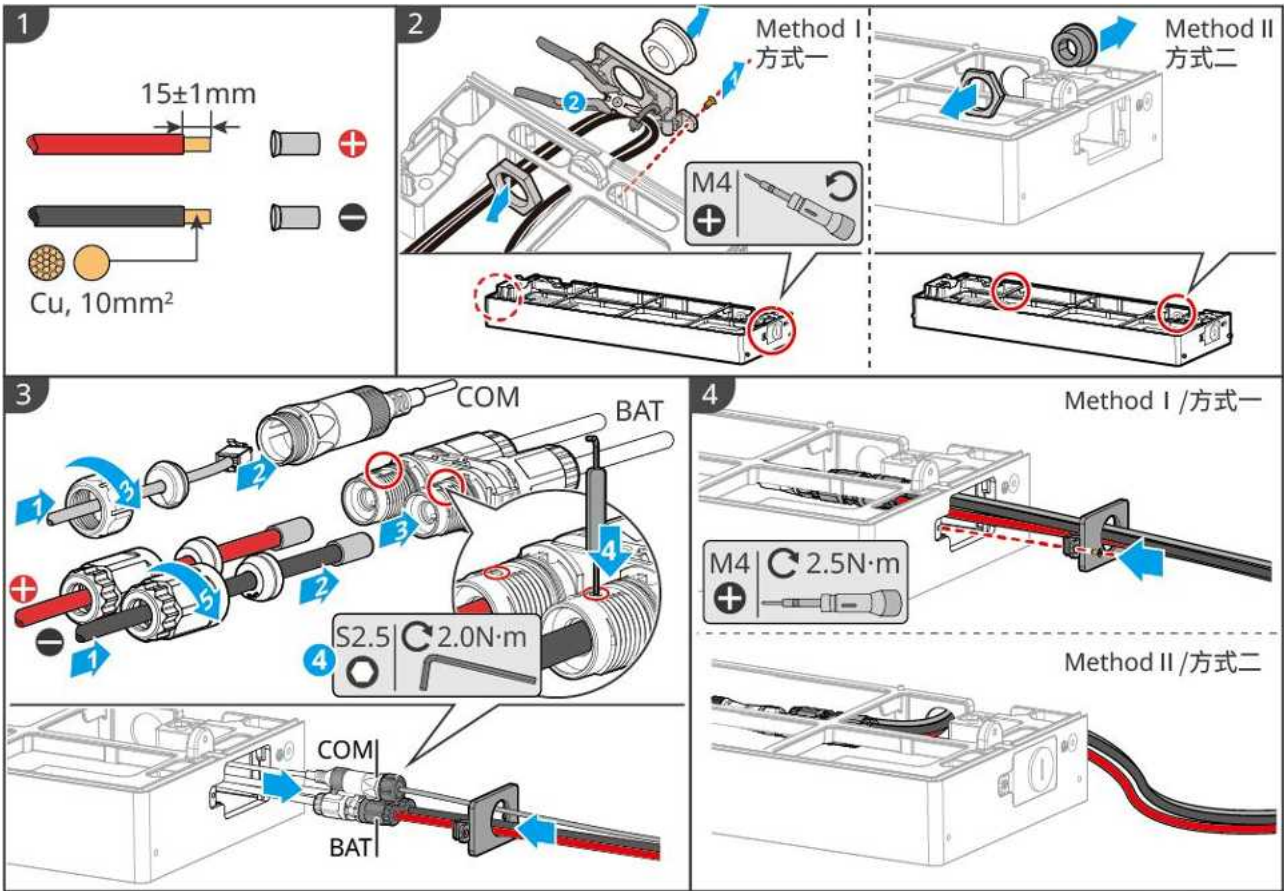

BAT20ELC0004

5.7 Connecting the AC Cable

⚠ WARNING

- The inverter integrates a Residual Current Monitoring Unit (RCMU) internally to prevent the residual current from exceeding the specified value. When the inverter detects a leakage current greater than the permissible value, it will quickly disconnect from the grid.
- During wiring, ensure the AC wires fully match the "BACKUP" and "ON-GRID" ground ports of the AC terminals. Incorrect cable connection will cause equipment damage.
- Ensure the wire cores are fully inserted into the terminal wiring holes with no exposed parts.
- Ensure the insulating plate at the AC terminal is securely fastened and not loose.
- Ensure cable connections are tight. Otherwise, overheating of the terminals during equipment operation may cause equipment damage.

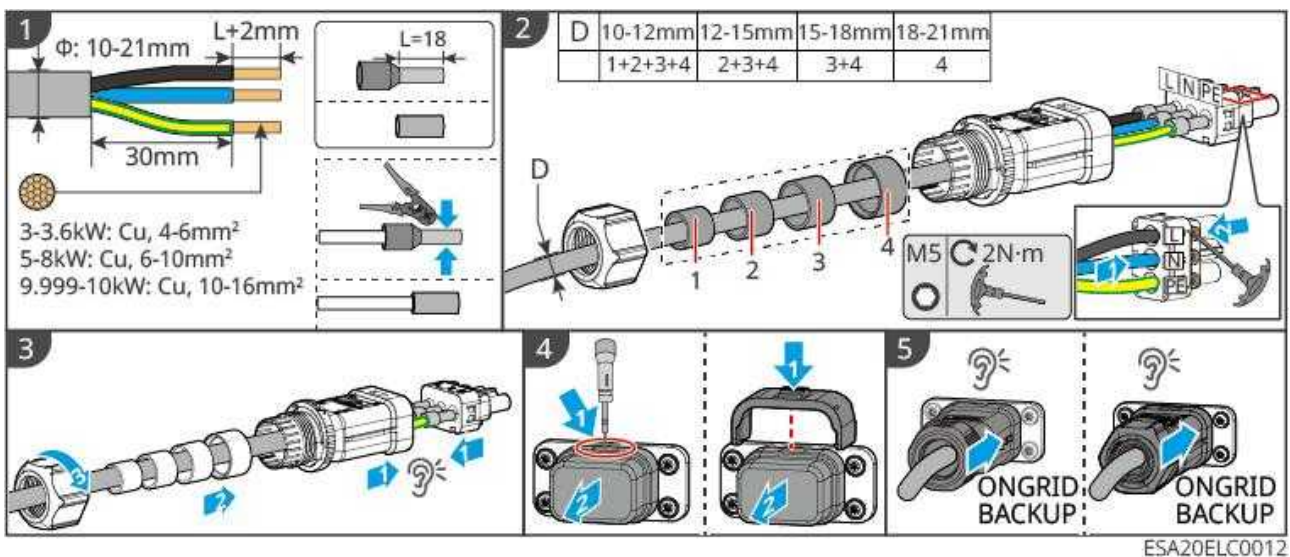

To disassemble the AC terminal, please refer to the following steps:



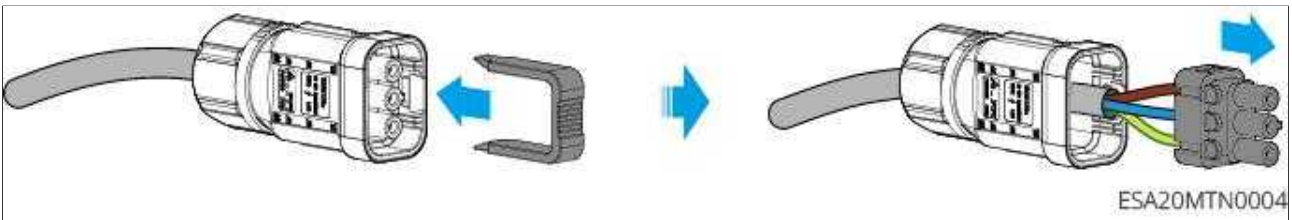

(Optional) Connecting the Manual Transfer Switch

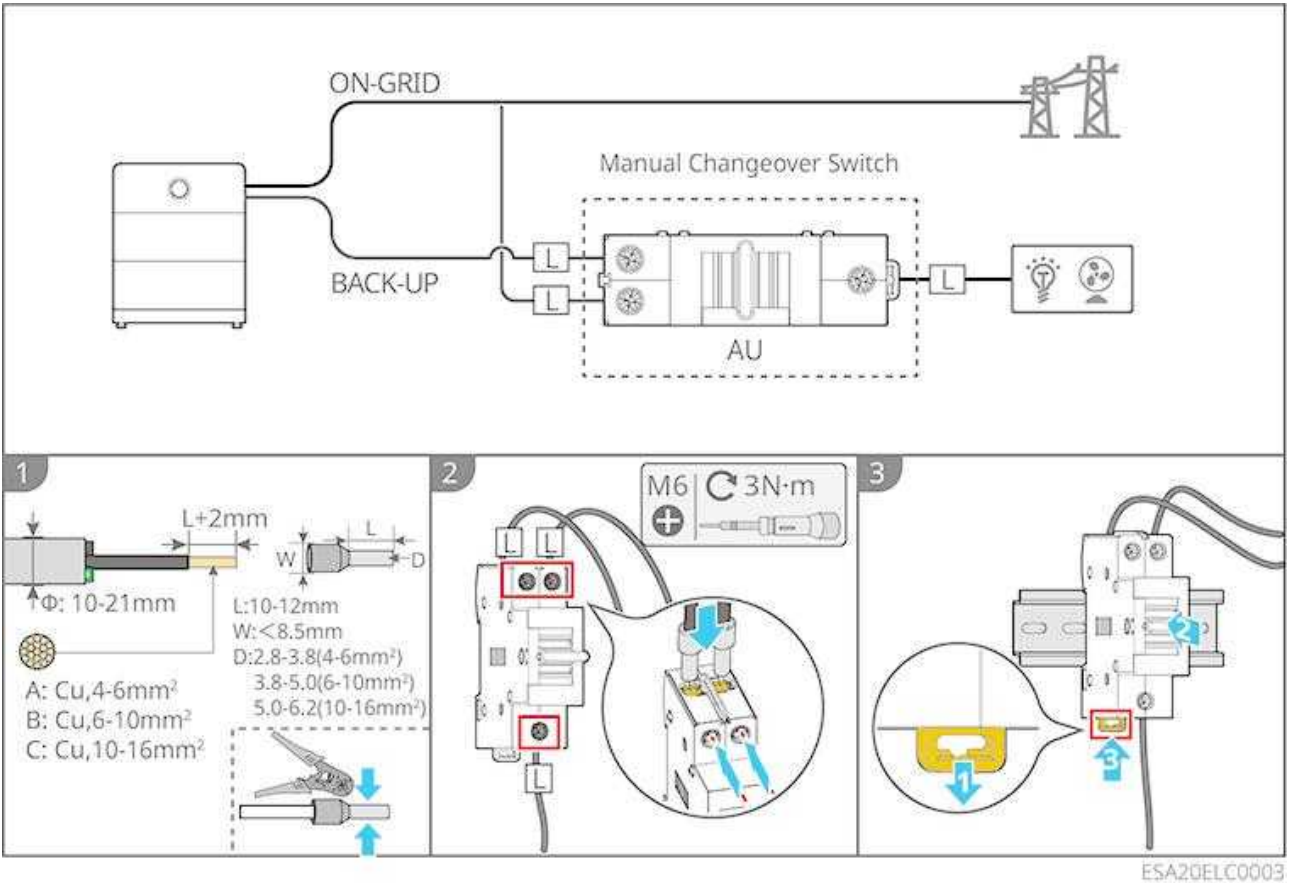

5.8 Connecting the Meter Cable

NOTICE

- If multiple InverterParallel Networking units are required, please consult the manufacturer to purchase the meter separately.
- Please ensure the CT connection direction is correct and the phase is accurate; otherwise, it may lead to incorrect monitoring data.
- Ensure all cable connections are correct, secure, and free from looseness. Improper wiring may cause poor contact or damage to the meter.
- In areas with lightning DANGER, if the meter cable length exceeds 10m and the cable is not laid with grounding Steel conduit, it is recommended to install external lightning protection devices.

GMK110 meter wiring

NOTICE

- The outer diameter of the AC power line must be smaller than the CT aperture to ensure the AC power line can pass through the CT.
- To ensure the current monitoring accuracy of the CT, the recommended length of the CT cable should not exceed 30 meters.
- Do not use network cables as CT cables, otherwise the meter may be damaged due to excessive current.
- The CTs provided by equipment manufacturers may vary slightly in size and appearance depending on the model, but the Installation wiring method remains consistent.

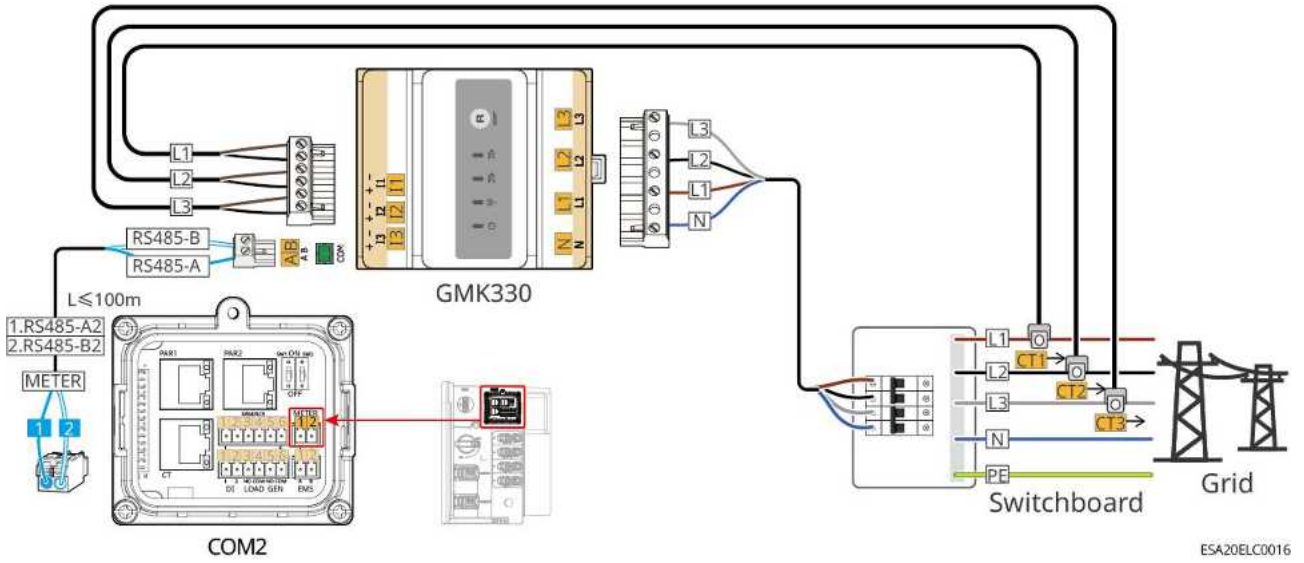

Wiring steps

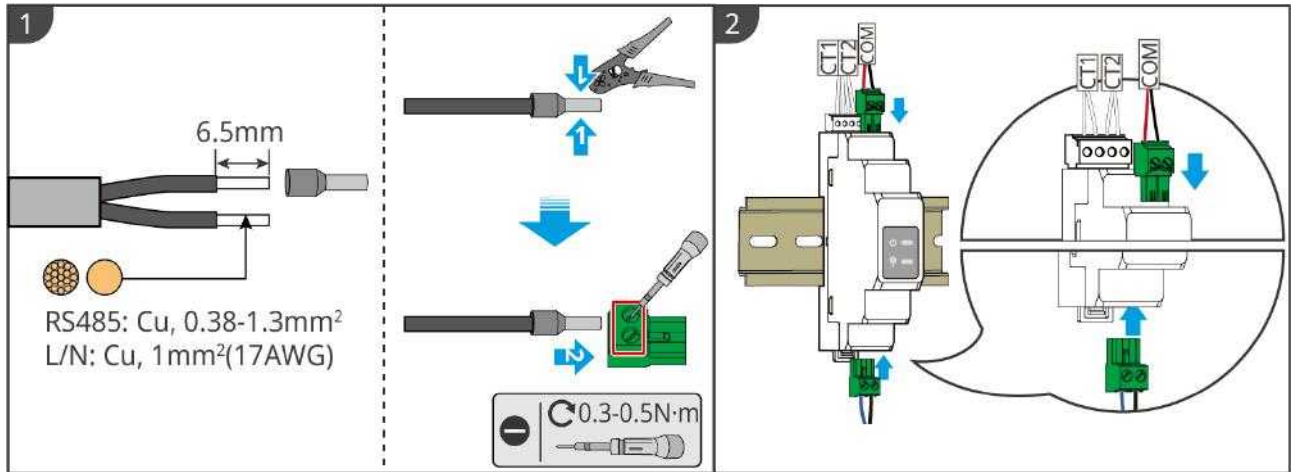

GM330 meter wiring

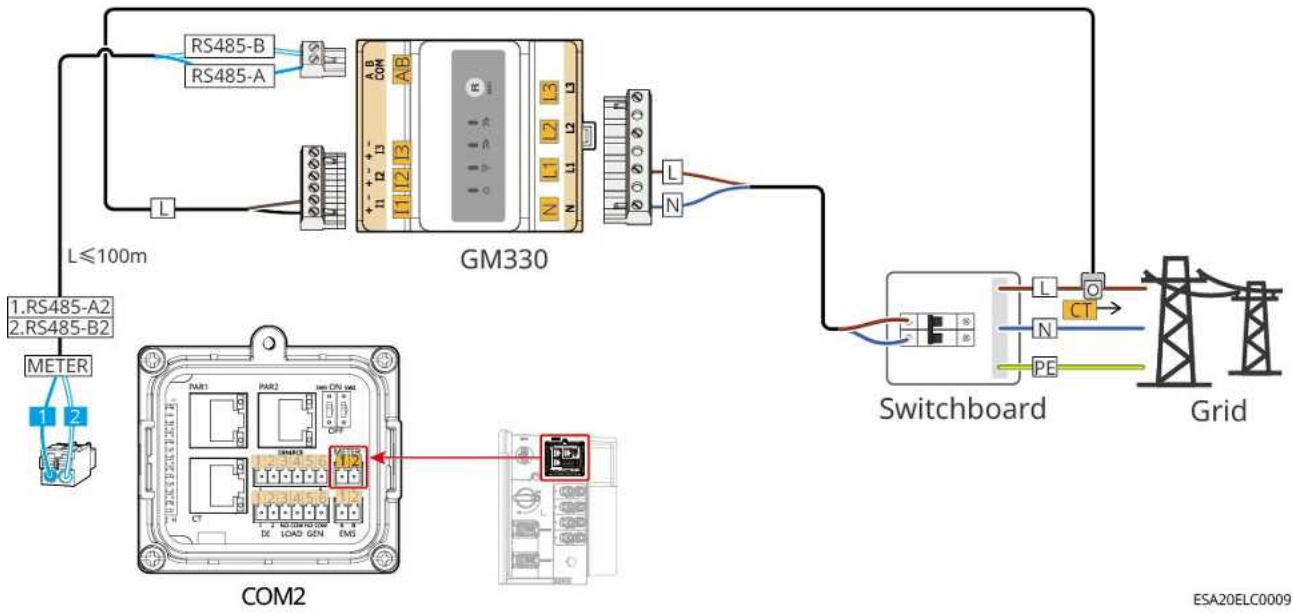

Wiring steps

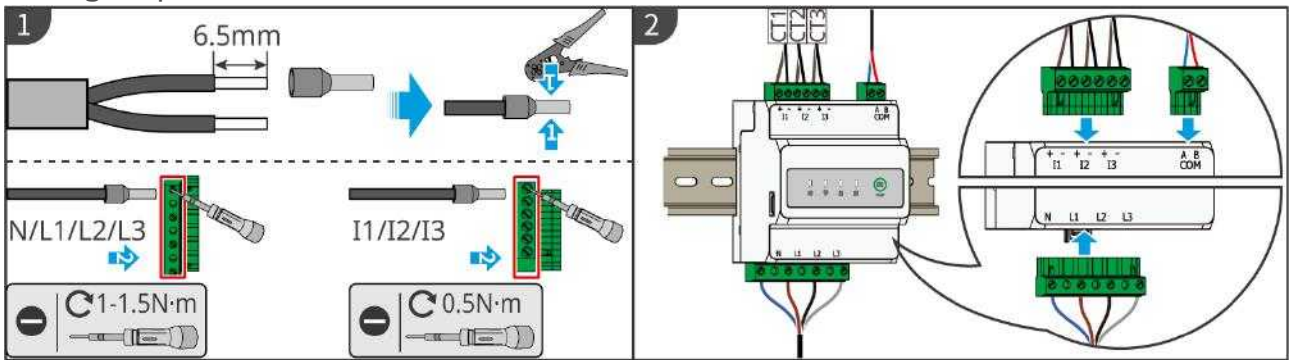

Installation CT (Type 1)

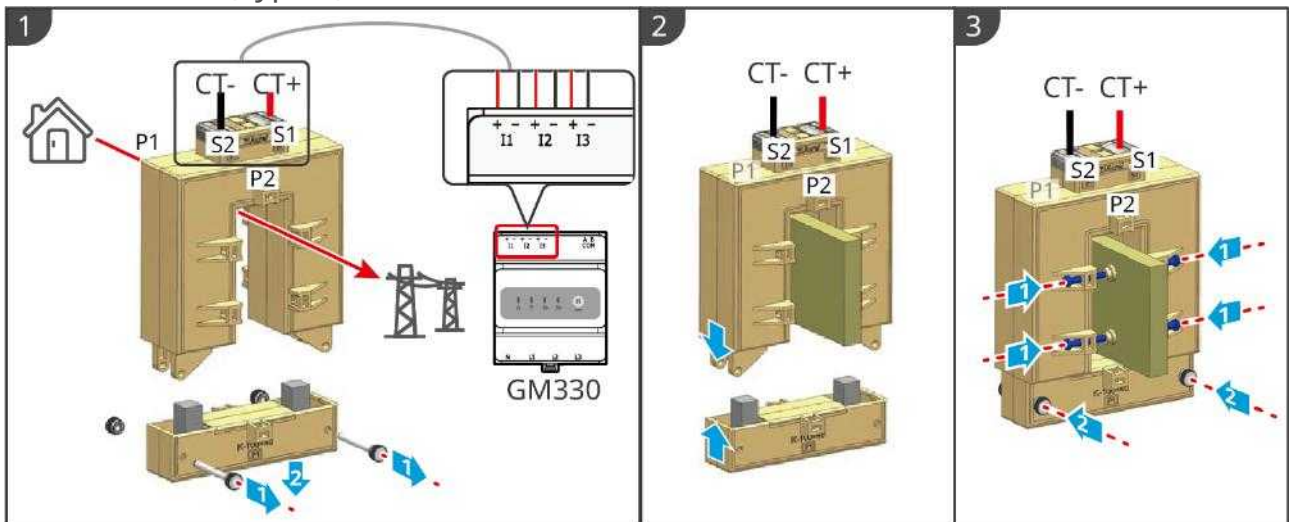

Installation CT (Type II)

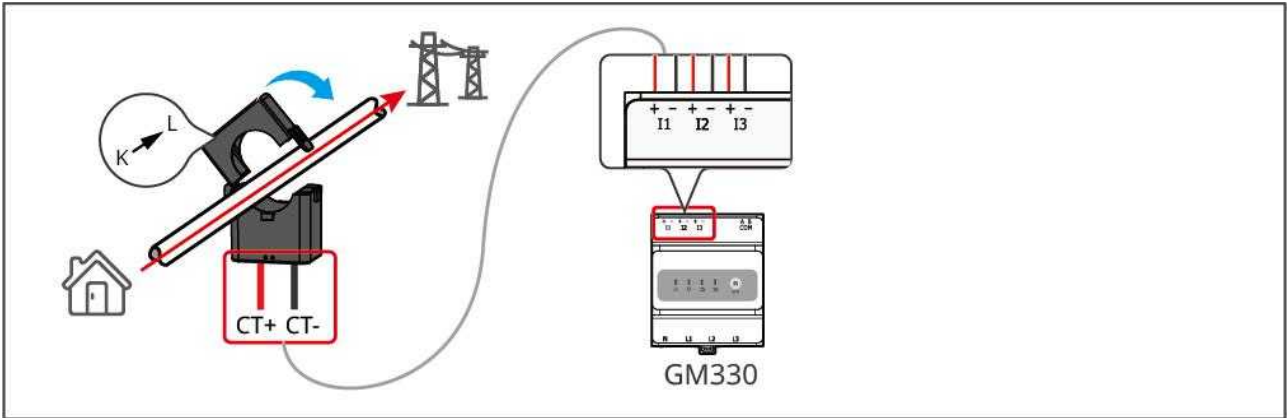

GMK10ELC007

5.9 Connecting the Inverter Communication Cable

NOTICE

- When using the built-in Inverter meter, please use the CT shipped with the unit.
- Please connect the CT according to the direction indicated by the meter. If reversed, it may cause CT reverse fault.
- For use if required DRED、RCR Or Remote Shutdown function, please ensure the wiring is completed before proceeding. SolarGo App Enable this function.
- If Not Connected DREDDo not operate equipment or Remote Shutdown equipment while SolarGo App Enable this function, otherwise the Inverter cannot on-grid operate.
- In a parallel system, to implement the DRED and RCR functions, simply connect the DRED and RCR Communication cable to Master inverter.
- To ensure the waterproof rating of the Inverter, do not dismantle the unused waterproof plugs on the Inverter.
- Inverter DO Signal Communication Port, can be connected to dry contact A. Signal specifications and parameters: Max ≤ 24Vdc, 1A.
- Inverter Communication function is optional, please select according to actual usage scenarios.
- Inverter supports connecting to mobile phones or WEB interfaces via 4G, Bluetooth, WiFi, and LAN communication methods to set device-related parameters, view device operation information and error messages, and promptly understand system status.
- In a single-unit system, it supports Installation WiFi/LAN Kit-20 or 4G Kit-CN-G20 Smart dongle.
- In the parallel system, each main Slave inverter must be equipped with a Installation WiFi/LAN Kit-20 Smart dongle for networking.
- When using the 4G Kit-CN-G20:
 - For Parallel Networking, please contact GoodWe to purchase the WiFi/LAN Kit-20.
 - China region standard-equipped Micro-SIM card, carrier is mobile communication. Please confirm that the device Installation is within the carrier's signal coverage area. If local mobile signal is not covered, please contact the carrier to optimize the signal.
 - Supports connection to third-party monitoring platforms via the MQTT communication protocol.
- The 4G Kit-CN-G20 is an LTE single-module device, suitable for application scenarios with lower requirements for data transmission rates.

Communication Function Description

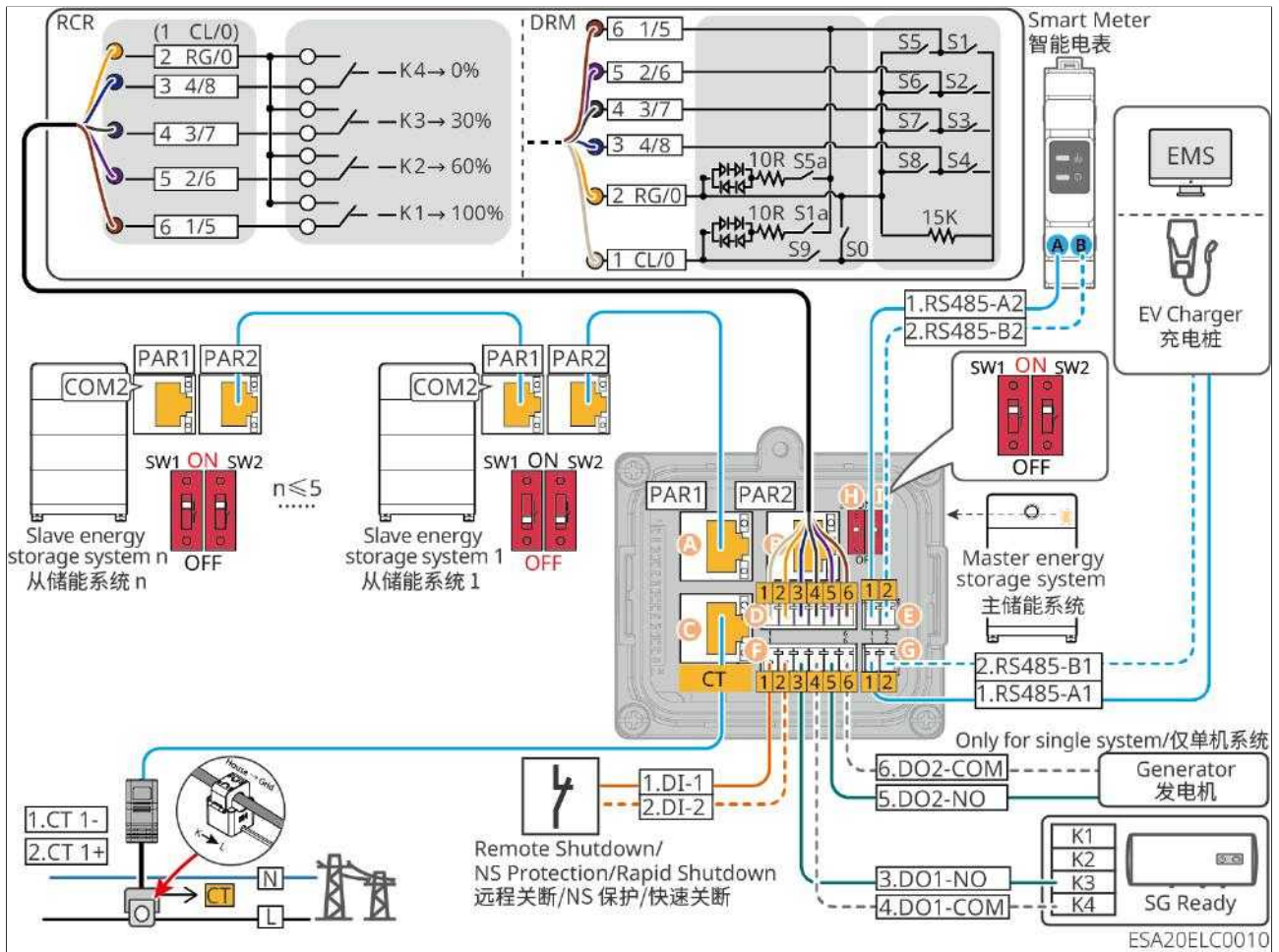

port (Screen Printing)		Function	Description
A	PAR1	Parallel connection Communication Port1	Parallel operation Please use CAT 5E and above standard network cable and RJ45 RJ45 connector
B	PAR2	Parallel Connection Communication Port 2	
C	CT	CTConnection port	Only the built-in meter of Inverter needs to be connected when in use.CTCommunication cable cable.

port (Screen Printing)		Function	Description
D	DRM/RCR	RCR、DRED or EnWG 14a Functional connection port	<ul style="list-style-type: none"> RCR (Ripple Control Receiver) Provide RCR Signal control port, meeting the dispatching requirements of Utility grid in European regions. DRED (Demand Response Enabling Device) Provided DRED Signal control port, compliant with regions such as Australia DERDCertification requirements.
E	METER	Meter connection	Use RS485 Communication connection to external Smart Meter.
F	DI	Remote Shutdown/NS protection/Rapid Shutdown	<ul style="list-style-type: none"> External Remote Shutdown or local NS protection Equipment, default off. In a Rapid Shutdown system, the Rapid Shutdown transmitter works in conjunction with the receiver to achieve system Rapid Shutdown. The receiver maintains module output by receiving signals from the transmitter. The transmitter can be externally mounted or integrated into the Inverter. In emergency situations, the transmitter can be deactivated by enabling an external trigger device, thereby shutting down the module.
	LOAD	load control	<ul style="list-style-type: none"> Supports connection to dry contact signals for functions such as load control. DO Contact capacity is 24V DC@1A, NO/COM Normally open contact. Support SG ReadyHeat pump connection, controlling the heat pump through dry contact signals.

port (Screen Printing)		Function	Description
	GEN	Diesel Generator Control port	The single-unit grid connection supports the integration of Diesel Generator Control signals to control generator start/stop. Generator connection is not supported under Microgrid Scenario.
G	EMS	EMS/Charging Pile Communication Port	Connect third-party EMS devices for energy control or connect to GoodWe Charge charging piles.
H	SW1	Parallel DIP switch	In a multi-unit parallel scenario, the parallel DIP switches of the first and last Inverter units should be set to the ON position, while the other Inverter units should be set to the OFF position.
I	SW2		

Connection method for Communication cable

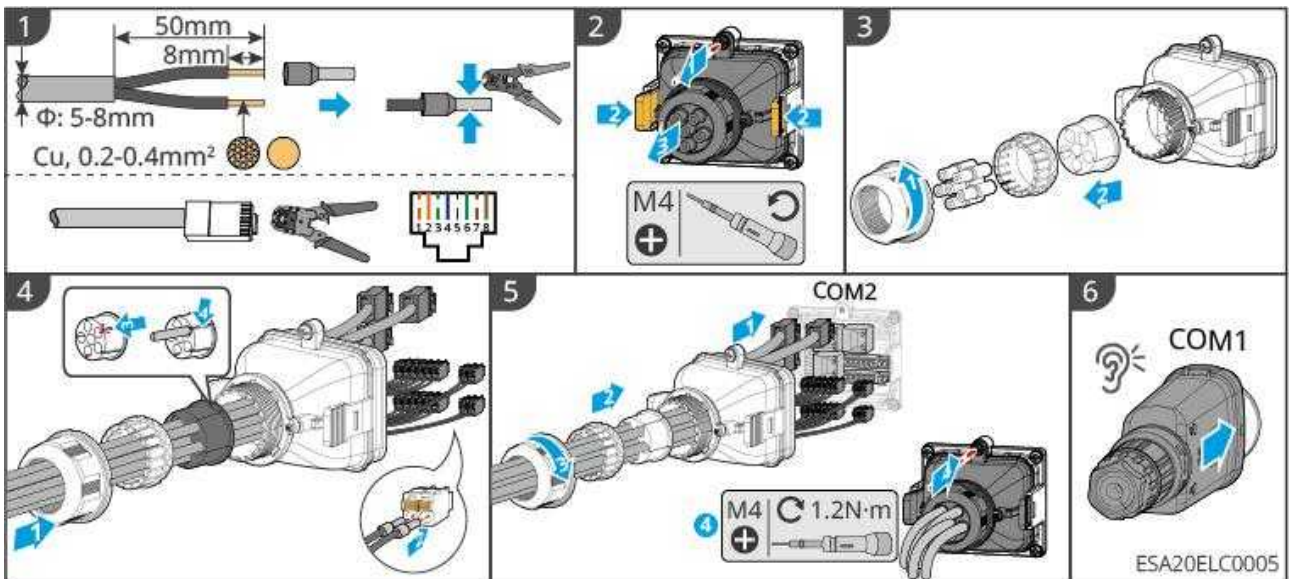

6 System Commissioning

6.1 Check Before Power ON

No.	Check Item
1	The inverter is firmly installed in a clean place where is well-ventilated and easy to operate.
2	The PE, DC, AC, communication cables are connected correctly and securely.
3	The cable binding shall comply with routing requirements, with reasonable distribution and no damage.
4	Unused wire holes and ports should connect with reliable terminals provided with the accessories and be sealed up.
5	The used cable holes are sealed.
6	The voltage and frequency at the connection point meet the inverter grid connection requirements.

6.2 Power ON

 **WARNING**

- Battery Black Start: When there is no PV power generation in the photovoltaic system and Utility grid is abnormal, if Inverter cannot operate normally, the Battery black start function can be used to forcibly start Inverter via Battery discharge. Inverter can then enter off-grid mode, with Battery supplying power to the load.
- After Battery system is started, ensure that Inverter communicates normally with Battery system within 15 minutes. If Inverter fails to communicate normally with Battery system, the Battery system switch will automatically trip, and Battery system will undergo POWER OFF.
- During normal operation, set the manual transfer switch to position B, and the load is powered by the Inverter BACK-UP port. When performing maintenance on the Inverter power off or during fault, to ensure continuous power supply to the load, switch the manual transfer switch to position A, and the load will be powered by the Utility grid.
- PV strings and "Step 5" are only applicable to the EHA series.

power on

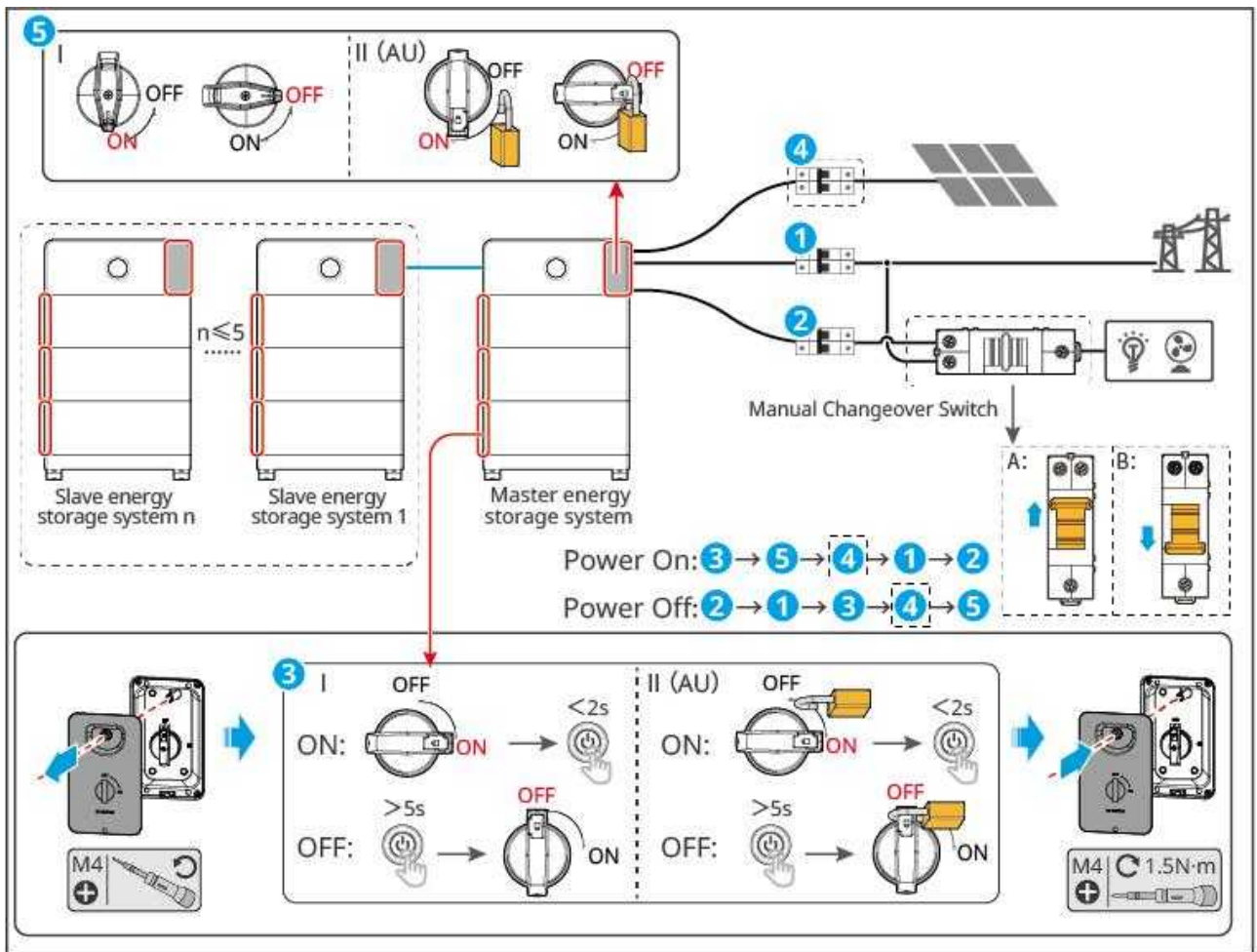

ESA20PWR0002

1. Close the Battery power switch and briefly press the multifunction button on the Battery. When there are multiple Battery in the system, ensure all Battery power switches are closed. Briefly pressing the multifunction button on any Battery will start all Battery.
2. Close the DC Switch of Inverter.
3. (Optional)PVThe breaker between the module and the Inverter is closed.
4. Turn ONGRIDbreaker closed
5. convertBACK-UPbreaker closed, (optional) manual transfer switch turned toBStatus.

Black start

1. Close the Battery power switch. When there are multiple Battery in the system, it is necessary to close the power switches of all Battery.
2. Close the DC Switch of Inverter.

3. (Optional)PVThe breaker between the module and the Inverter is closed.
4. Turn ON-GRIDbreaker closed.
5. Close the BACK-UP breaker.
6. All Battery are power on separately, wait for 15 seconds, then press the multifunction button of any Battery for 2 seconds, and Battery will forcibly activate Inverter.

6.3 Installing Protective Cover

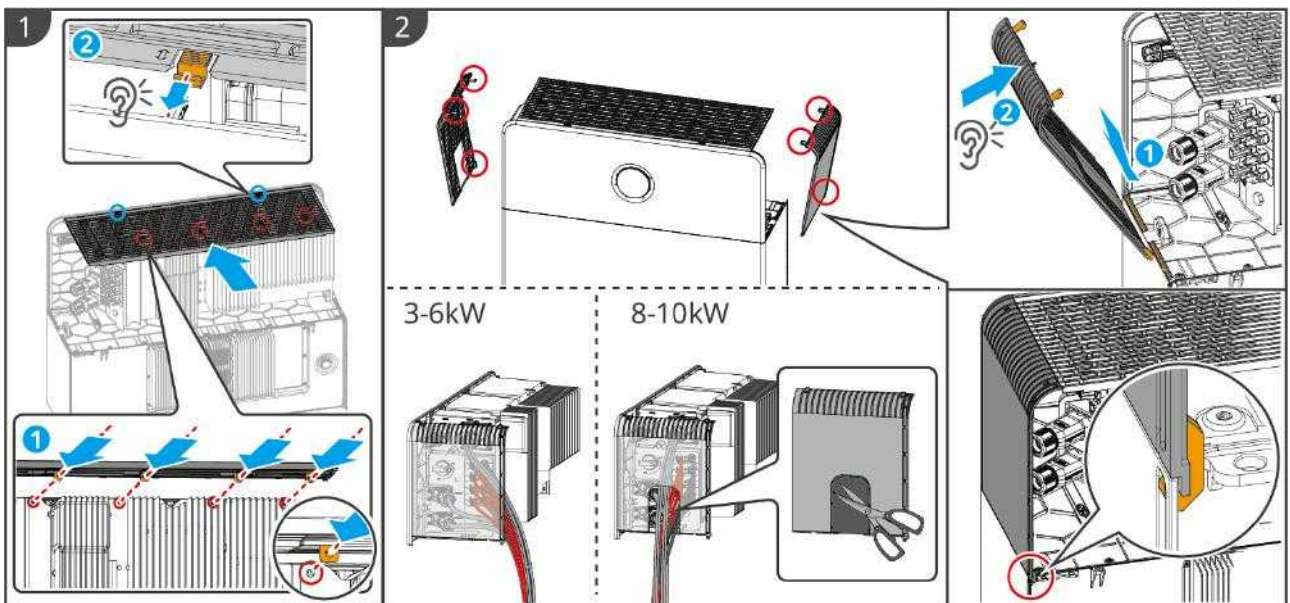

ESA20INT0006

6.4 Indicators

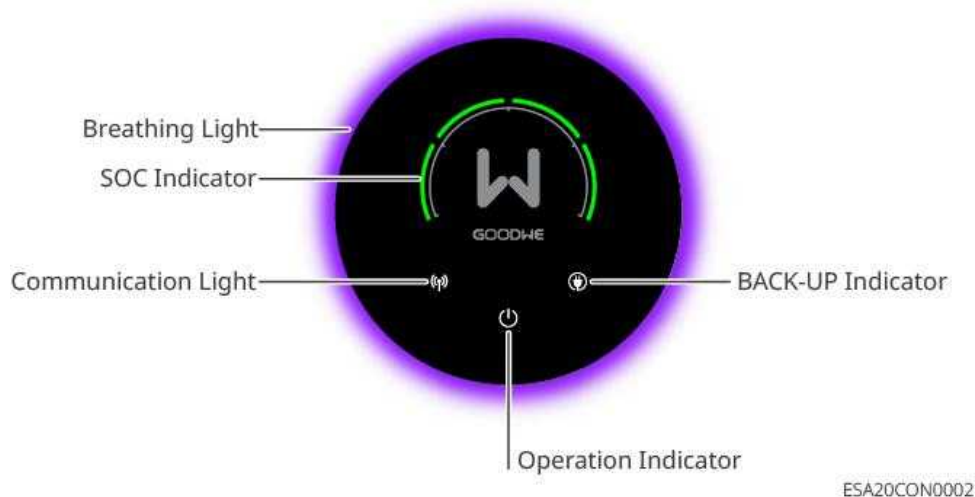

6.4.1 Inverter Indicators





















ESA20CON0002

Breathing Light:

- When the system is in upgrade status: The breathing light is a green running light; the head of the running light is the brightest and the tail is the dimmest, the length of the running light and the upgrade percentage are affected by the XiaoGu CloudWindow+ App settings and the device's operating status.
- Except for inverter upgrade, system fault, and inverter power-off status, the breathing light status is affected by the App settings in the XiaoGu CloudWindow+ App. For setup instructions, please refer to the XiaoGu CloudWindow+ App User Manual.

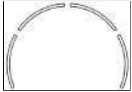
Indicator	Indicator Status	Breathing Light Status	Description
		<ul style="list-style-type: none"> • 3min/Always On: Blue-purple chasing light stays on 	The inverter is powered on and in standby mode
		<ul style="list-style-type: none"> • Always Off: Off 	The inverter is starting up and in self-check mode

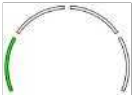
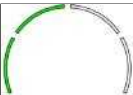
Indicator	Indicator Status	Breathing Light Status	Description
		<ul style="list-style-type: none"> • 3min: Blue-purple breathing for 3min then turns off • Always On in App: Blue-purple breathing stays on • Always Off in App: Off 	The inverter is operating normally in grid-tied power generation or off-grid mode
		Red flashing	System fault
		Off	The inverter is powered off
		/	Inverter monitoring module is resetting
			No connection established between inverter and communication terminal
			Communication failure between communication terminal and cloud server
			Inverter monitoring is normal
			Inverter monitoring module not started
			
			Grid normal, inverter BACK-UP port power supply normal
			No power supply to BACK-UP port

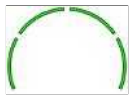
Indicator	Indicator Status	Breathing Light Status	Description
			System upgrade
			System fault
			Battery has no charge
			Steady on: Charge Flashing: Discharge Battery SOC: $0\% < SOC \leq 25\%$
			Steady on: Charge Flashing: Discharge Battery SOC: $25\% < SOC \leq 50\%$
			Steady on: Charge Flashing: Discharge Battery SOC: $50\% < SOC \leq 75\%$
			Steady on: Charge Flashing: Discharge Battery SOC: $75\% < SOC \leq 100\%$



6.4.2 Battery Indicators



Button Indicator

No.	Green light	 Red light	Battery system	Description
1	On		The system is working normally.	Run
2	Blinks 1 time/S.	--	The system is ready.	Standby
	Blinks 3 time/S.	--	The PCScommunication is lost.	--
3	Blinks 1 time/ 2S.	--	System Alarm	When there is an under-voltage fault of level 2, 3, or 4, the indicator flashes. For other level 2 faults, the indicator flashes.
4	--	On	System Failure	Fault list showing faults of level 3 or higher (undervoltage faults remain ON when at level 5)



6.4.3 Smart Meter Indicator

GM330

Type	Status	Description
Power light 	On	Power on, no RS485 communication.
	Blinks.	Power on, RS485 communication works properly.
	Off	The smart meter has been powered off.
Communication indicator 	Off	Reserved
	Blinks.	Press the Reset button for more than 5 seconds, power light, buying or selling electricity indicator light flash: Reset the meter.
	On	Importing from the grid.
	Blinks.	Exporting to the grid.

Type	Status	Description
Importing or exporting indicator 	Off	Do not import from and export to the grid.
	Reserved	

GMK110



Type	Status	Description
Power light 	On	The smart meter is power on.
	Off	The smart meter has been powered off.
Communication indicator 	Blinks.	Meter communication is normal.
	Off	Meter communication is abnormal or has no communication.





6.4.4 Smart Dongle Indicator

- WiFi/LAN Kit-20

Note

- After double press the Reload button to turn on Bluetooth, the communication indicator light will switch to single flash. Please connect to the SolarGo App within 5 minutes or Bluetooth will turn off automatically.
- The single flash status of the communication indicator only appears after double-press the Reload button to turn on Bluetooth.









Indicator	Status	Description
Power		Power On: The smart dongle is powered on.
		Power Off: The smart dongle is powered off.
		Power On: The WiFi or LAN communication is working well.

Indicator	Status	Description
Communication indicator		Blinks 1 time: The Bluetooth signal is on and waiting for connection to the SolarGo app.
		Blinks 2 times: The Smart Dongle is not connected to the router.
		Blinks 4 times: The Smart Dongle is communicating with the router but not connected to the server.
		Blinks 6 times: The Smart Dongle is identifying the connected device.
		Power Off: The software of the Smart Dongle is in reset or not powered on.

Indicator	Color	Status	Description
Communication indicator in LAN Port	Green	On	The 100Mbps wired network is normally connected.
		Off	<ul style="list-style-type: none"> The Internet cable is not connected. The 100Mbps wired network is abnormally connected. The 10Mbps wired network is normally connected.
	Yellow	On	The 10/100Mbps wired network is normally connected, but no communication data is received or transmitted.
		Blinks	The communication data is being transmitted or received.
		Off	The Internet cable is not connected.

Button	Description
Reload	Press and hold for 0.5 to 3 seconds to reset the Smart Dongle.
	Press and hold for 6 to 20 seconds to restore the Smart Dongle to factory settings.
	Double press quickly to activate Bluetooth signal (only lasts for 5 minutes).

• **4G Kit-CN-G20**

Indicator	Status	Description
		Power On: The Smart Dongle is powered on.
		Off The Smart Dongle is powered off.
		Power On: The Smart Dongle is connected to the server and the communication is normal.
		Blinks 2 times: The Smart Dongle is not connected to the foundation.
		Blinks 4 times: The Smart Dongle is connected to the foundation but disconnected to the server.
		Blinks 6 times: The Smart Dongle is not connected to the inverter.
		Power Off: The software of the Smart Dongle is in reset or not powered on.

Button	Description
RELOAD	Press and hold for 0.5 to 3 seconds to reset the Smart Dongle.
	Press and hold for 6 to 20 seconds to restore the Smart Dongle to factory settings.

7 Rapid System Configuration

7.1 Downloading the App

7.1.1 Downloading SolarGo App

Make sure that the mobile phone meets the following requirements:

- Mobile phone operating system: Android 5.0 or later, iOS 13.0 or later.
- The mobile phone can access the Internet.
- The mobile phone supports WLAN or Bluetooth.

NOTICE

Once the SolarGo App has been installed, you will receive automatic notifications when updates are available.

Method 1: Search SolarGo in Google Play (Android) or App Store (iOS) to download and install the app.



Method 2: Scan the QR code below to download and install the App.

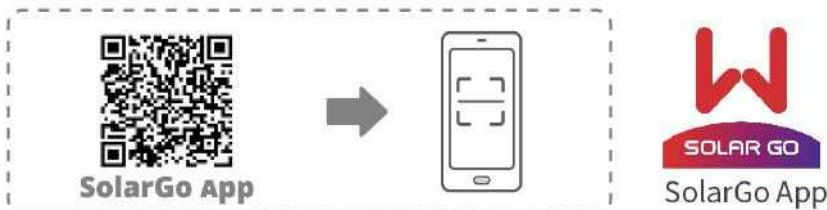

7.1.2 Downloading SEMS+ APP

Make sure that the mobile phone meets the following requirements:

- Mobile phone operating system: Android 6.0 or later, iOS 13.0 or later.
- The mobile phone can access the Internet.

- The mobile phone supports WLAN or Bluetooth.

Download Method:

Method 1:

Search SEMS+ in Google Play (Android) or App Store (iOS) to download and install the App.



Method 2:

Scan the QR code below to download and install the App.



7.2 Connecting the Hybrid Inverter (Bluetooth)

Step 1 Ensure that the inverter is power on, both the inverter and the communication module are working properly.

Step 2 Select **Bluetooth** tab on the SolarGo app homepage.

Step 3 Pull down or tap **Search Device** to refresh the device list. Find the device by the the inverter serial number. Tap the device name to log into the **Home** page. Select the device by checking the serial number of the master inverter when multi inverters are parallel connected.

Step 4 For first connection with the equipment via Bluetooth, there will be a Bluetooth pairing prompt, tap **Pair** to continue the connection.

Step 5 Log in as an Owner or an Installer. Initial password: 1234. Default password: 1234.

Step 6 (Optional): If connecting via WLA-*** or WFA-***, enable Bluetooth Stays On following the prompts as entering the device details page. Otherwise, the bluetooth signal of the device will be off after disconnection.

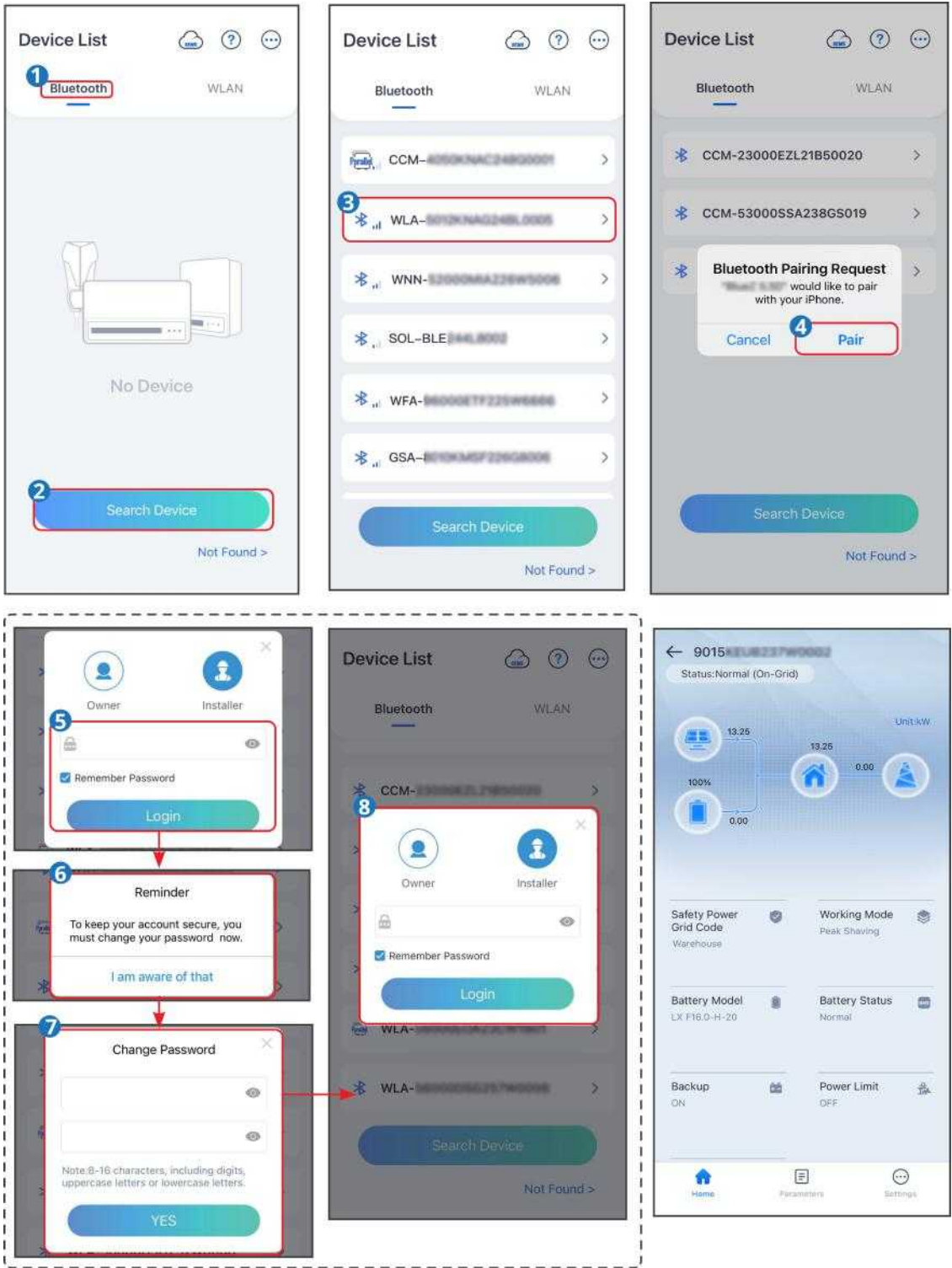

7.3 Connect the Smart Dongle

When connecting to an inverter via the SolarGo App, if the inverter signal cannot be detected, the device list interface will display the signal of the smart dongle

connected to the inverter.

Supported Smart Dongle types:

- WiFi/LAN Kit-20
- Ezlink3000
- 4G Kit-CN-G20 ; 4G Kit-CN-G21 ; 4G Kit-G20

Step 1: On the homepage of the SolarGo App, find the grayed-out SN number of the smart dongle and click to enter the settings interface.

Step 2: Set or query parameter information according to actual needs.

- Communication Configuration: Click to set WLAN/LAN parameters and connect the module to the router.
- Communication Module Logs: Click to enter the module log download interface.
- Device Information: Click to view the firmware version of the smart dongle. If a version update is available, you can refer to the on-screen prompts to complete the update.

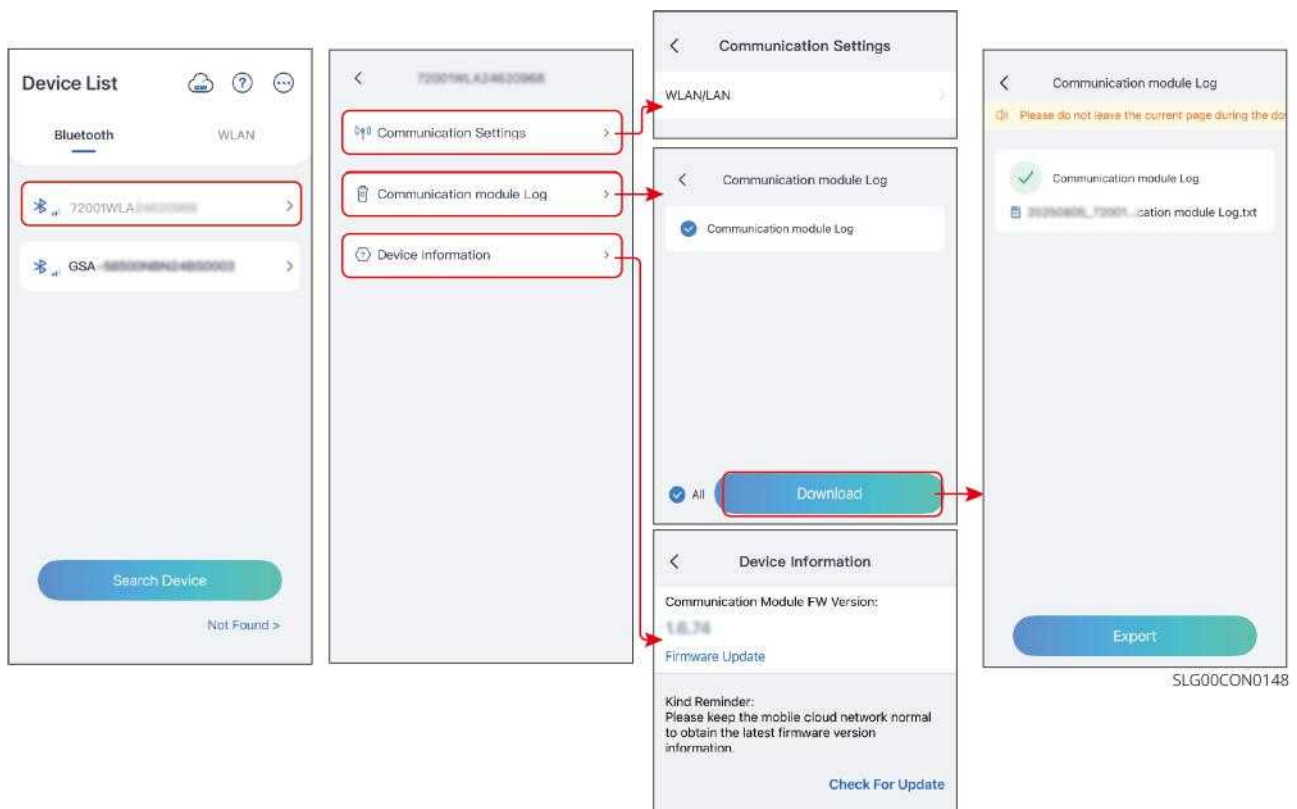

7.4 Setting Communication Parameters

NOTICE

The communication configuration interface may be different if the inverter uses different communication modes or connects different communication modules. Please refer to the actual interface.

7.4.1 Setting Privacy and Security Parameters

Type I

Step 1 : Tap **Home** > **Settings** > **Communication Setting** > **Privacy & Security** to set the parameters.

Step 2 : Set the new password for the WiFi hotspot of the communication module, and tap **Save**.

Step 3 Open the WiFi settings of your phone and connect to the inverter's WiFi signal (Solar WiFi**) with the new password.

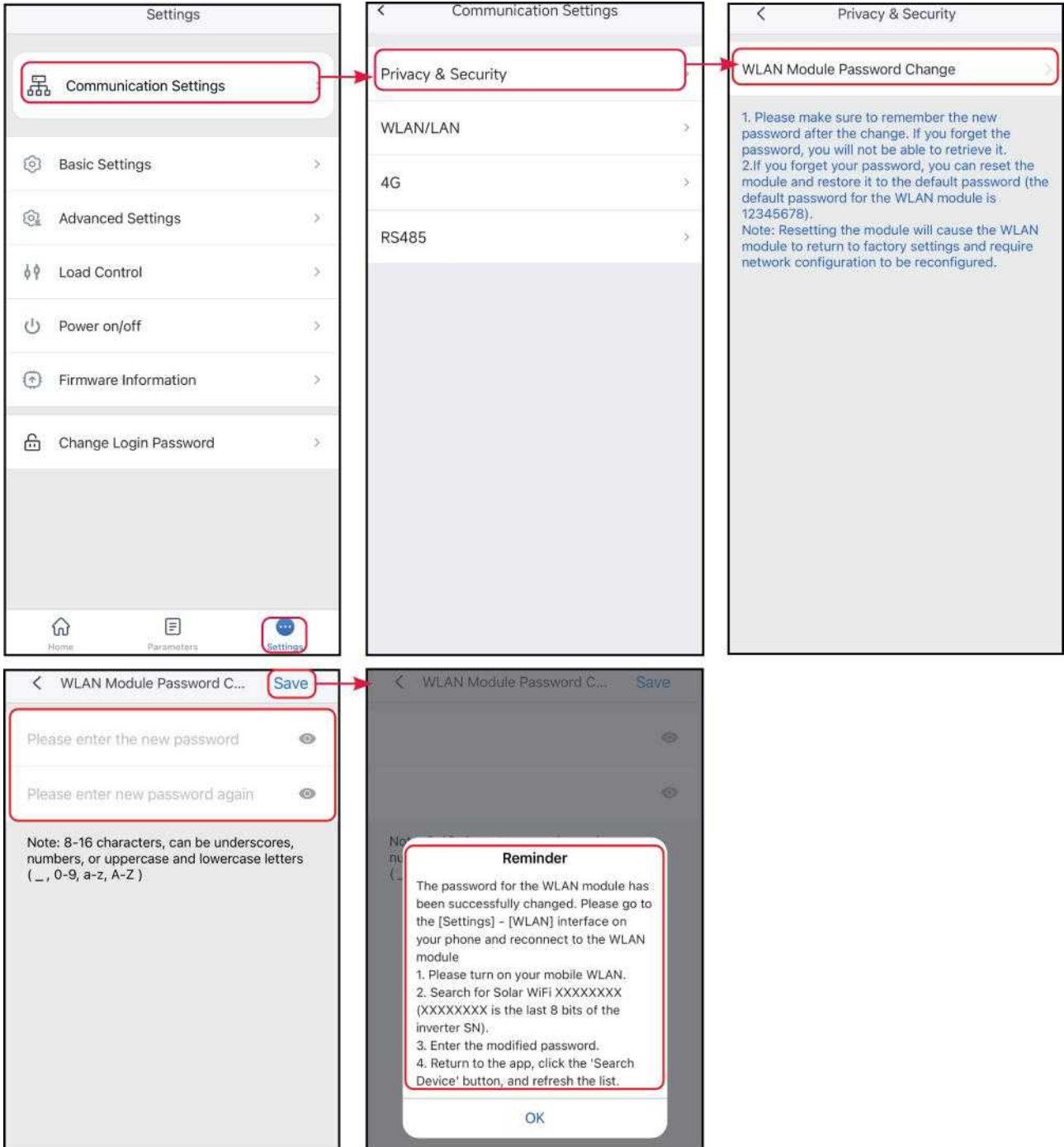

Type II

Step 1 : Tap **Home > Settings > Communication Setting > Privacy & Security** to set the parameters.

Step 2 Enable Bluetooth Stays On or WLAN Control based on actual needs.

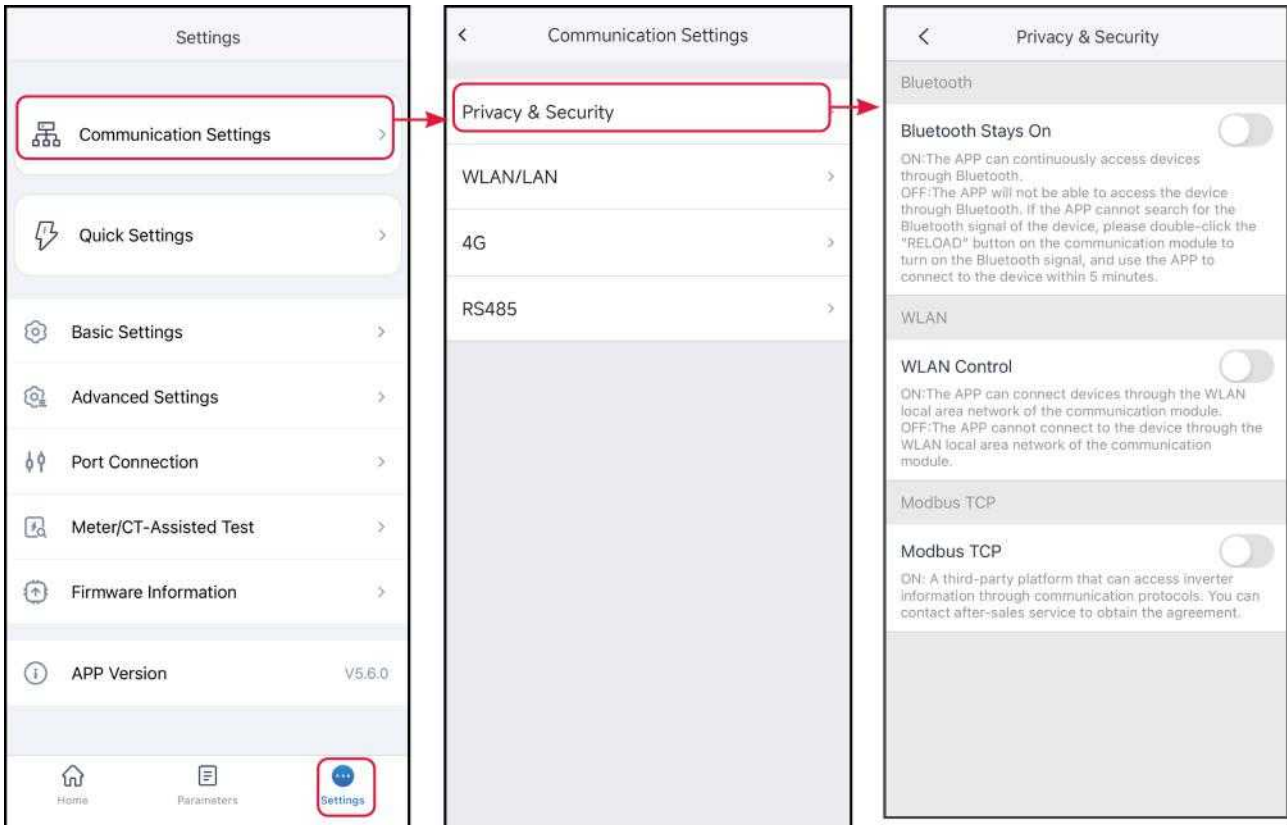

No.	Parameters	Description
1	Bluetooth Stays On	Disabled by default. Enable the function, the bluetooth of the device will be contentious on to keep connected to SolarGo. Otherwise, the bluetooth will be off in 5 minutes, and the device will be disconnected from SolarGo.
2	WLAN Control	Disabled by default. Enable the function, the device and the SolarGo can be connected through the WLAN when they are on the same LAN. Otherwise, they cannot be connected even if they are on the same LAN.
3	Modbus-TCP	Enable the function, the third party monitoring platform can access inverter through Modbus-TCP communication protocol.
4	SSH control Ezlink	After enabling this function, third-party platforms can connect to and control EzLink's Linux system.

Type III

Step 1 : Tap **Home > Settings > Communication Setting > Privacy & Security** to set

the parameters.

Step 2 : Enable **Bluetooth Stays On** or **Login Password** based on actual needs.

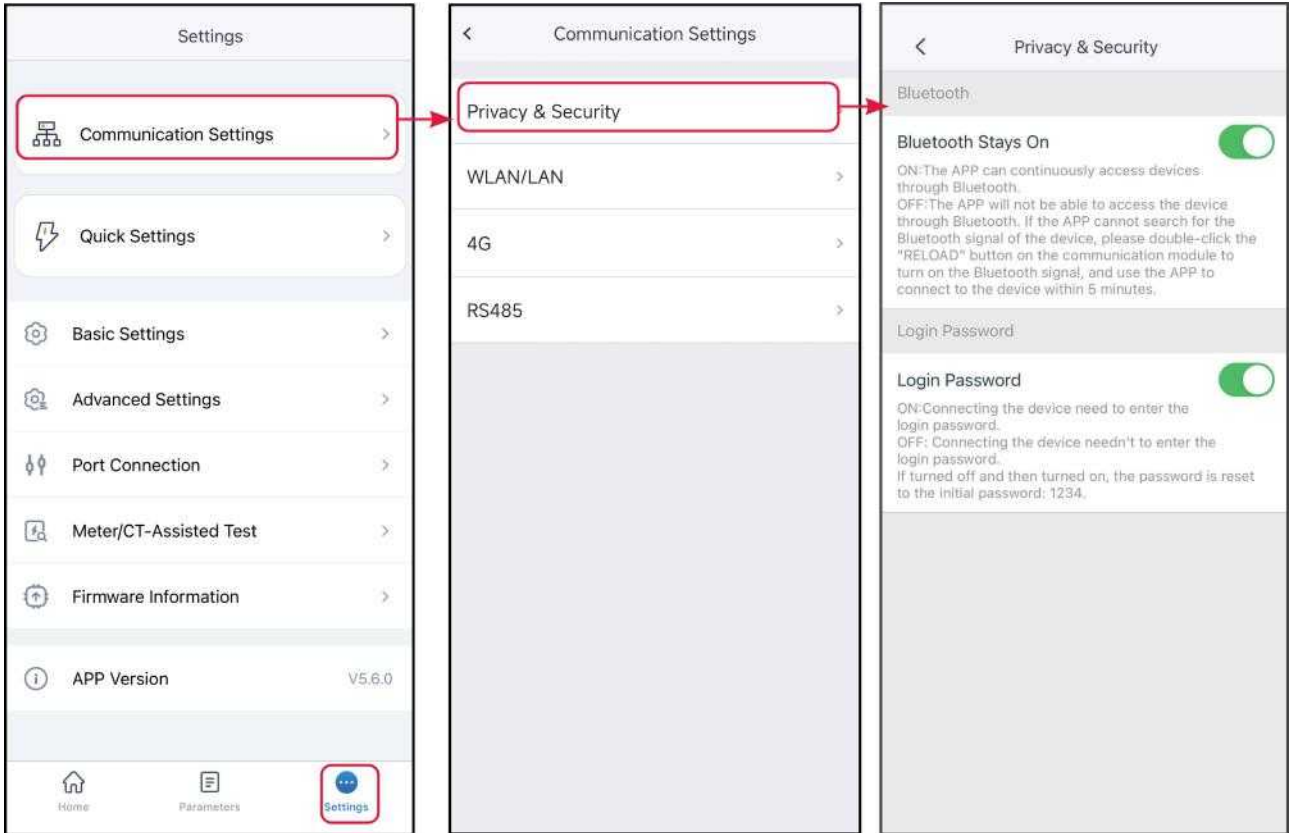

No.	Parameters	Description
1	Bluetooth Stays On	Disabled by default. Enable the function, the bluetooth of the device will be contentious on to keep connected to SolarGo. Otherwise, the bluetooth will be off in 5 minutes, and the device will be disconnected from SolarGo.
2	Password	Disabled by default. Enable the function, you will be prompted to enter the login password when connecting the device to SolarGo. Use the initial password and change it at the first login prompt.

7.4.2 Setting WLAN/LAN Parameters

NOTICE

When the inverter is connected to different communication modules, the communication configuration interface may be different. Please refer to the actual interface.

Step 1 : Tap **Home > Settings > Communication Setting > WLAN/LAN** to set the parameters.

Step 2 : Configure the WLAN or LAN parameters based on actual needs.

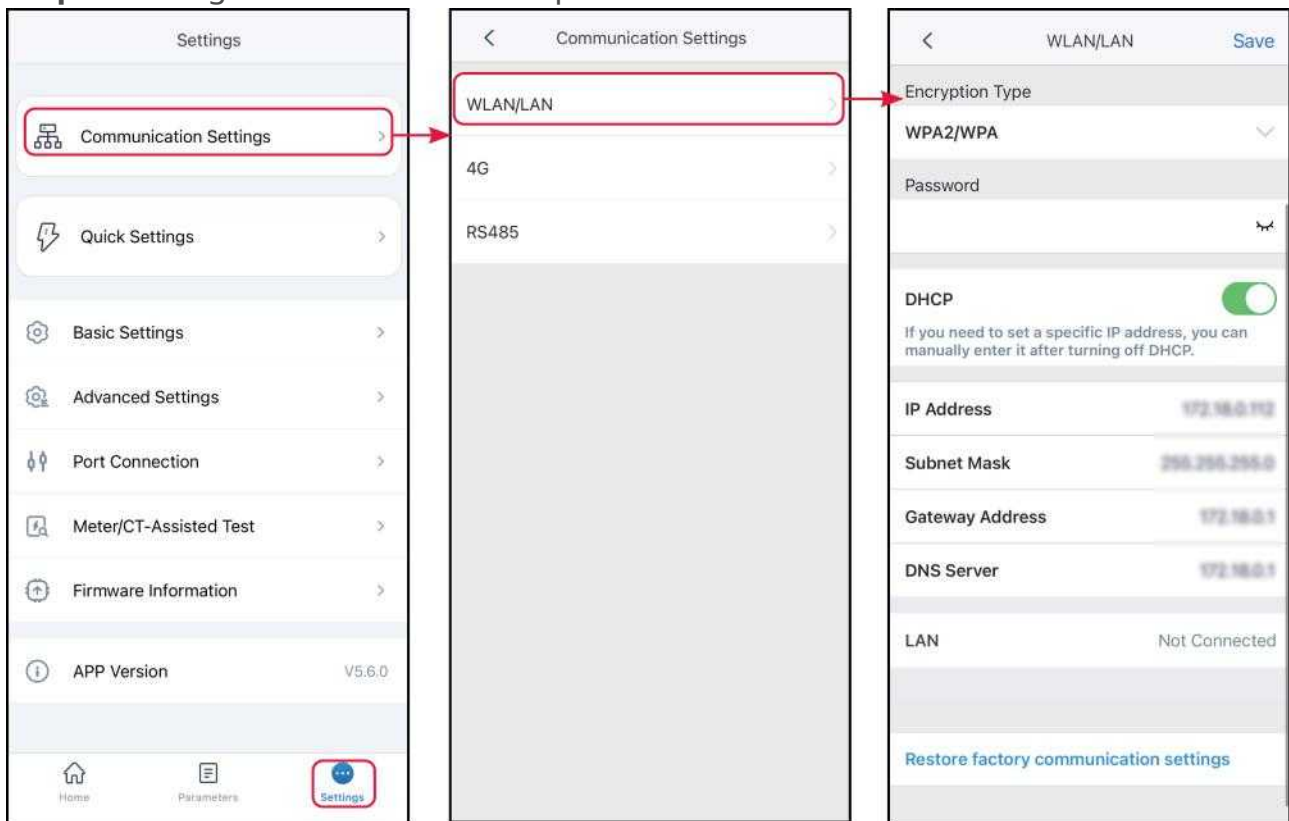

No.	Parameters	Description
1	Network Name	Only for WLAN. Select WiFi based on the actual connecting.
2	Password	Only for WLAN. WiFi password for the actual connected network.
3	DHCP	Enable DHCP when the router is in dynamic IP mode. Disable DHCP when a switch is used or the router is in static IP mode.

No.	Parameters	Description
4	IP Address	Do not configure the parameters when DHCP is enabled. Configure the parameters according to the router or switch information when DHCP is disabled.
5	Subnet Mask	
6	Gateway Address	
7	DNS Server	

7.4.3 Configuring RS485 Parameters

NOTICE

Set the communication address of the inverter. For a single inverter, the address is set based on actual needs. For multi connected inverters, the address of each inverter should be different while cannot be 247.

Step 1: Tap **Home > Settings > Communication Settings > RS485** to set the parameters.

Step 2 : Set the Modbus Address And Baud Rate base on actual situation.

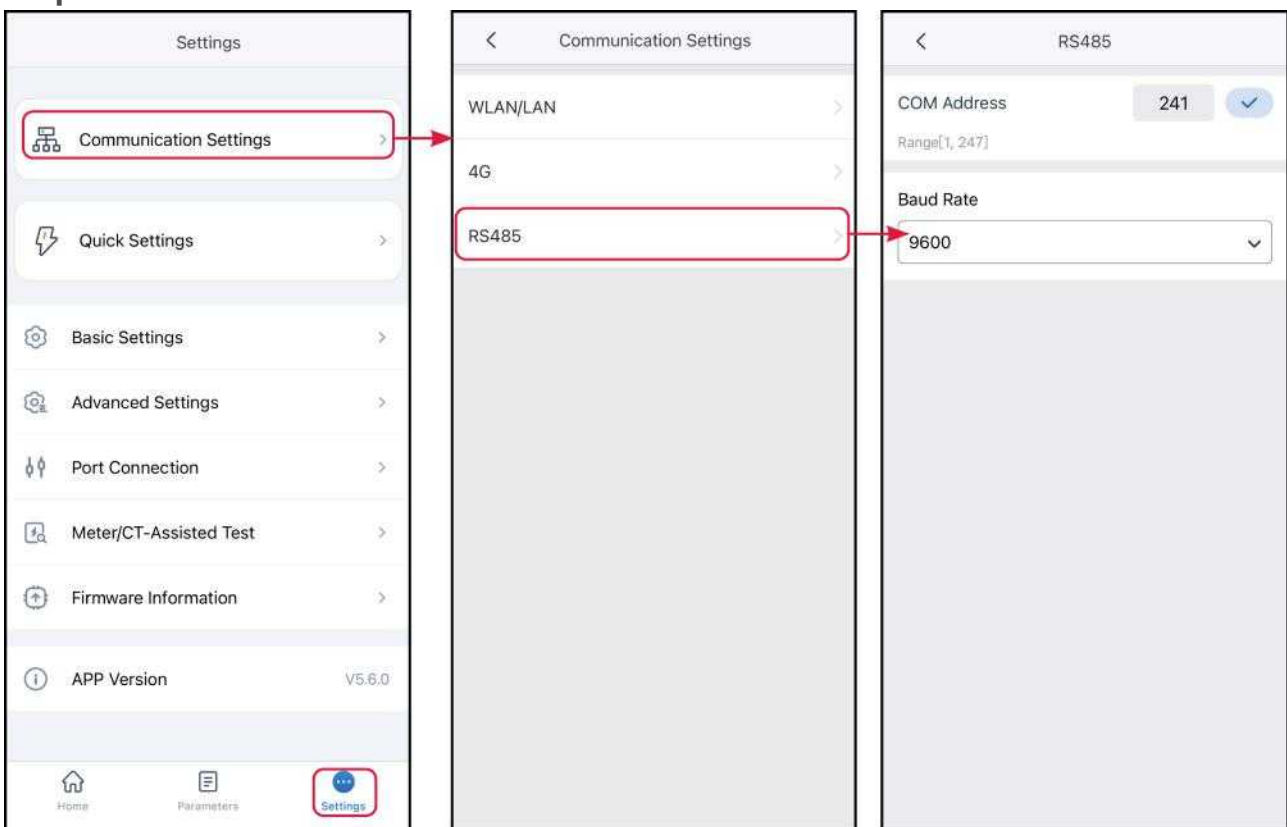

7.5 Quick Setting the Basic Information

NOTICE

- The setting page varies depending on inverter model.
- The parameters will be configured automatically after selecting the safety country/region, including overvoltage protection, undervoltage protection, overfrequency protection, underfrequency protection, voltage/frequency connection protection, $\cos\phi$ curve, Q(U) curve, P(U) curve, FP curve, HVRT, LVRT, etc. Tap Home > Settings > Advanced Settings > Safety Parameters to check the parameters after selecting the safety country.
- The power generation efficiency is different in different working modes. Set the working mode according to the local requirements and situation.
 - Self-use mode: The basic working mode of the system. PV power generation is used to supply power to the load first, the excess power is used to charge the battery, and the remaining power is sold to the grid. When PV power generation cannot meet the load's power demand, the battery will supply power to the load; when the battery power also cannot meet the load's power demand, the grid will supply power to the load.
 - Back-up mode: The back-up mode is mainly applied to the scenario where the grid is unstable. When the grid is disconnected, the inverter turns to off-grid mode and the battery will supply power to the load; when the grid is restored, the inverter switches to grid-tied mode.
 - Economic mode: It is recommended to use economic mode in scenarios when the peak-valley electricity price varies a lot. Select Economic mode only when it meets the local laws and regulations. Set the battery to charge mode during Vally period to charge battery with grid power. And set the battery to discharge mode during Peak period to power the load with the battery.
 - Off-grid mode: suitable for areas without power grid. PV and batteries form a pure off-grid system. PV generates electricity to power the load and excess electricity charges the battery. When PV power generation cannot meet the power demand of the load, the battery will supply power to the load.
 - Smart charging: In some countries/regions, the PV power feed into the utility grid is limited. Select Smart Charging to charge the battery using the surplus power to minimize PV power waste.
 - Peak shaving mode: Peak shaving mode is mainly applicable to peak power limited scenarios. When the total power consumption of the load exceeds the power consumption quota in a short period of time, battery discharge can be used to reduce the power exceeding the quota.

7.5.1 Quick Setting the Basic Information(Type I)

Step 1: Tap **Home > Settings > Quick Settings** to set the parameters.

Step 2 : Enter the password for quick settings. Contact the supplier or after sales service for password. Password for professional technicians only.

Step 3 : Some models support one-click configuration. Select **Guided Mode** to quickly configure the system.

Step 4: Select Grid Code(Safety Code)accordingly. Tap **Next** to set the Working Mode.

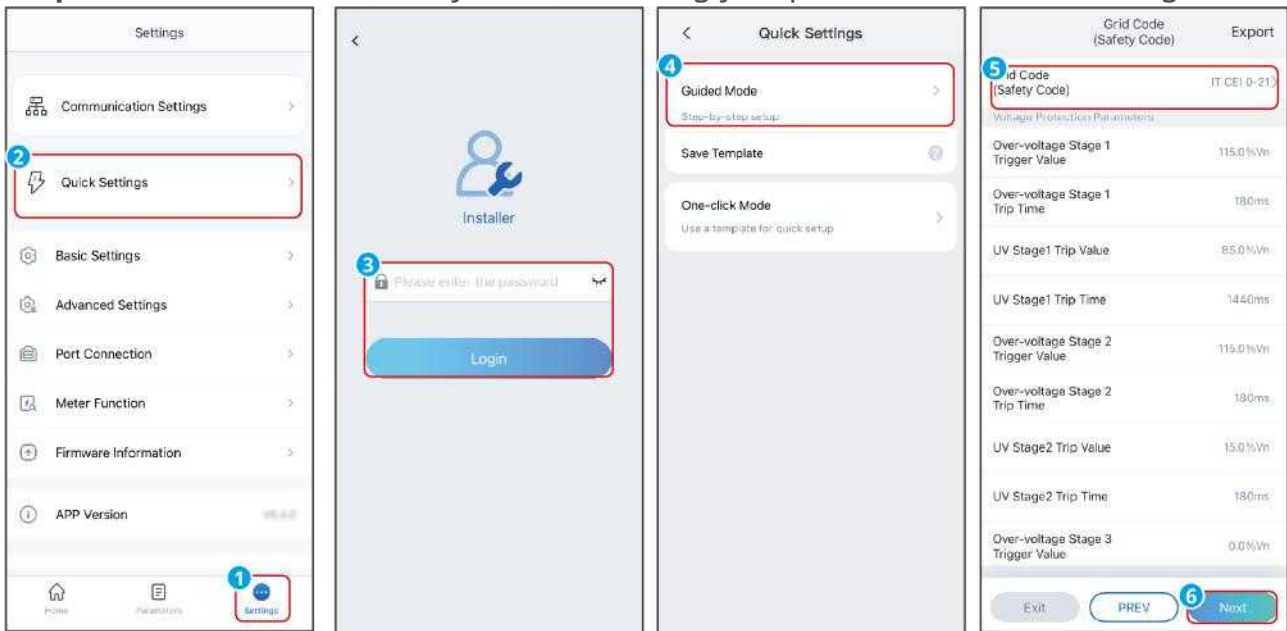

SLG00CON0121

Step 5: Set the working mode based on actual needs. Tap **Next** to set the Working Mode. For some models, after the working mode configuration is completed, it will automatically enter the CT/meter self-test state. At this time, the inverter will temporarily disconnect from the grid and then automatically reconnect.

Step 6 : Select the battery based on actual situation whether it is **First Installation, Routine Operation** or **Replacement Installation**.

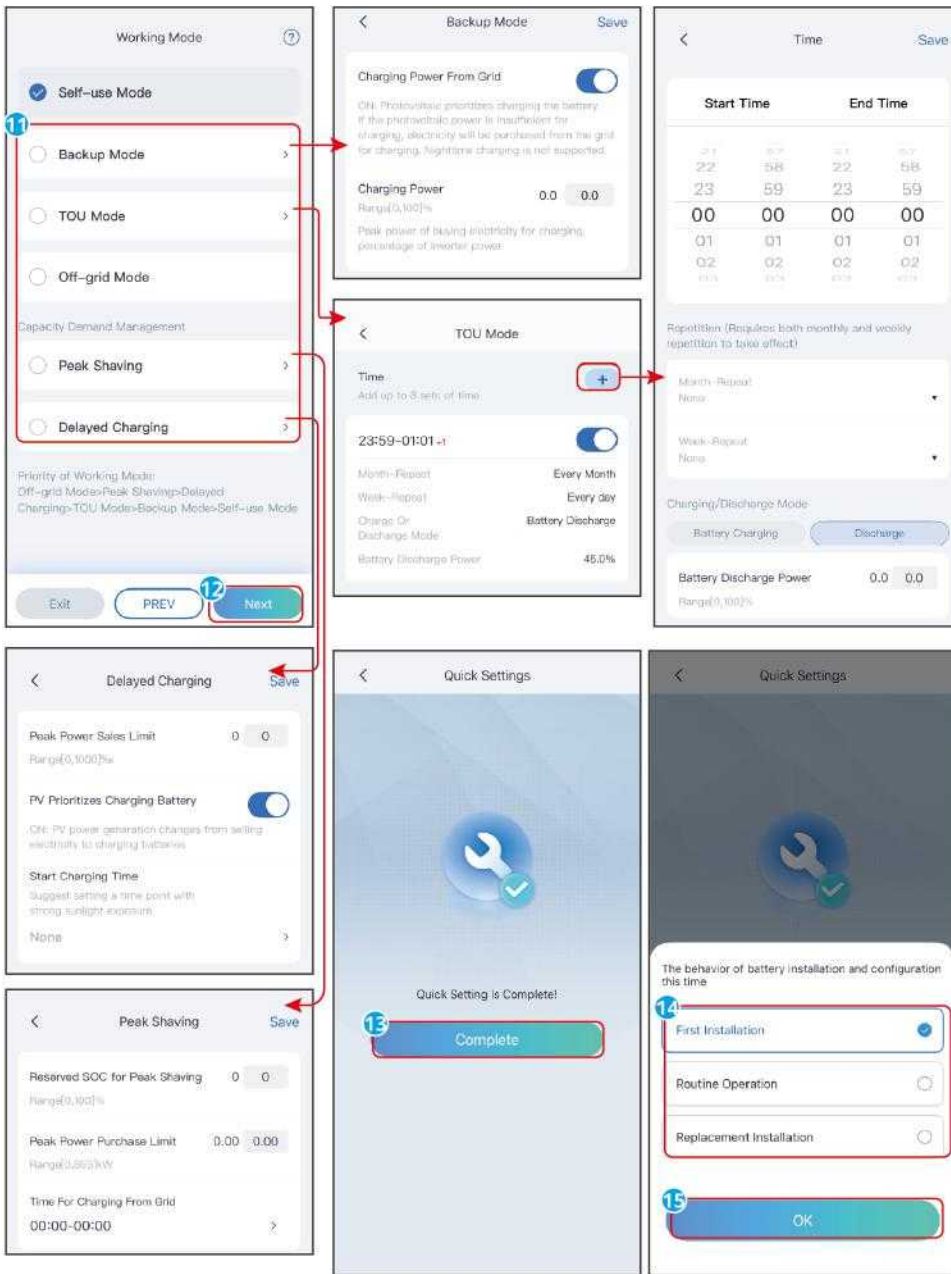

SLG00CON0060

No.	Parameters	Description
Back-up mode		
1	Charging Power From Grid	Enable Charging Power From Grid to allow power purchasing from the utility grid.
2	Charging Power	The percentage of the purchasing power to the rated power of the inverter.
TOU mode		

No.	Parameters	Description
3	Start Time	Within the Start Time and End Time, the battery is charged or discharged according to the set Battery Mode as well as the Rated Power.
4	End Time	
5	Charge Discharge Mode	Charge or discharge according to actual needs.
6	Rated Power	The percentage of the charging/discharging power to the rated power of the inverter.
7	Charge Cut-off SOC	The battery stop charging/discharging once the battery SOC reaches Charge Cut-off SOC.
Peakshaving		
8	Reserved SOC For Peakshaving	In Peak Shaving mode, the battery SOC should be lower than Reserved SOC For Peakshaving. Once the battery SOC is higher than Reserved SOC For Peakshaving, the peak shaving mode fails.
9	Peak Power Purchase Limit	Set the maximum power limit allowed to purchase from the grid. When the loads consume power exceed the sum of the power generated in the PV system and Peak Power Purchase Limit, the excess power will be made up by the battery.
10	Time for Charging From Grid	The utility grid will charge the battery between Start Time and End Time if the load power consumption do not exceed the power quota. Otherwise, only PV power can be used to charge the battery. Otherwise, only PV power can be used to charge the battery.
Smart charging		
11	Peak Power Sales Limit	Set the Peak Power Sales Limit in compliance with local laws and regulations. The Peak Limiting Power shall be lower then the output power limit specified by local requirements.
12	PV Prioritizes Charing Battery	During charging time, the PV power will first charge the battery.

No.	Parameters	Description
13	Start Charging Time	

Step 7 : For devices that support one-click configuration, a template can be generated based on the completed configuration.

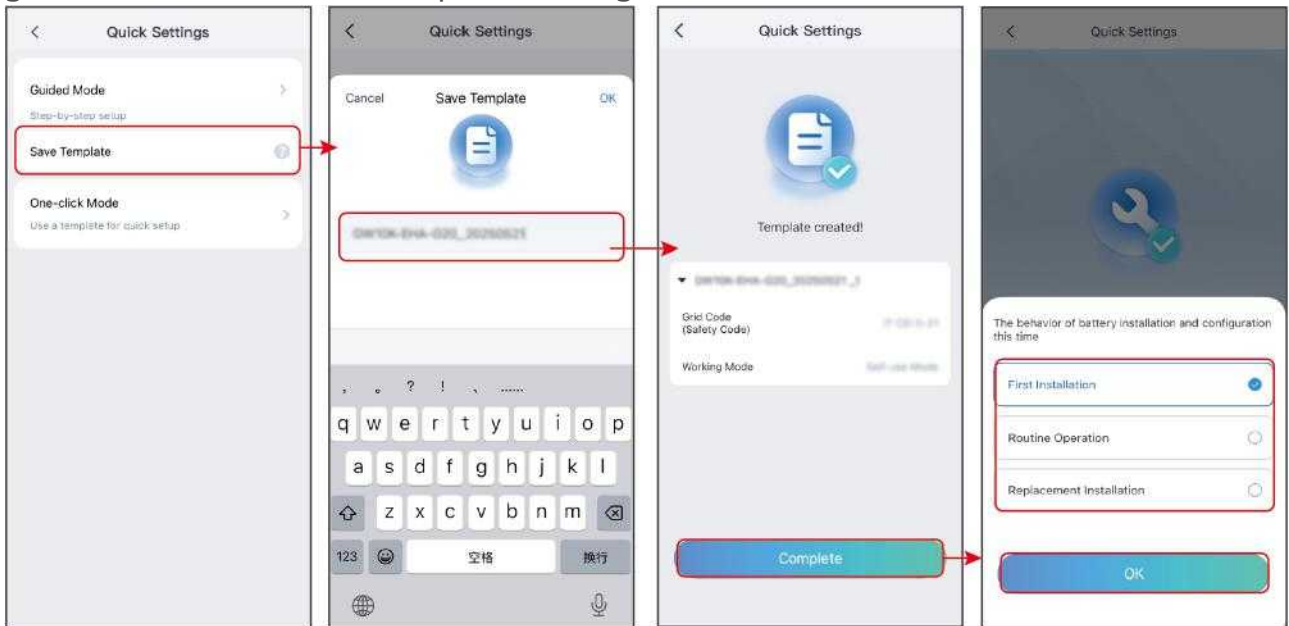

SLG00CON0119

Step 8: If you already have a one-click configuration template, you can use the existing template direct import mode to quickly complete the configuration.

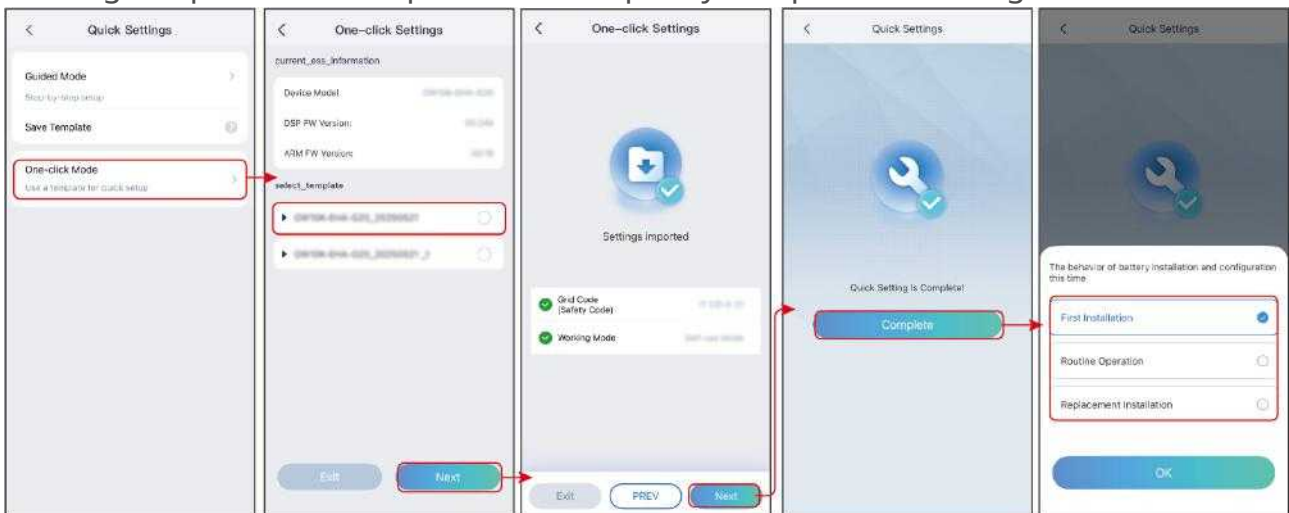

SLG00CON0120

7.6 Creating a Station

Step 1: Tap **+** on overview or station page, or tap **Create Station** on service page.

Step 2: Enter station information on the **Creat Station** page.

Step 3: Tap **Save&Exit** to complete creating a station, without devices added. Or tap **Save&Continue** to add devices. Support adding multiple devices.

SEMS0011

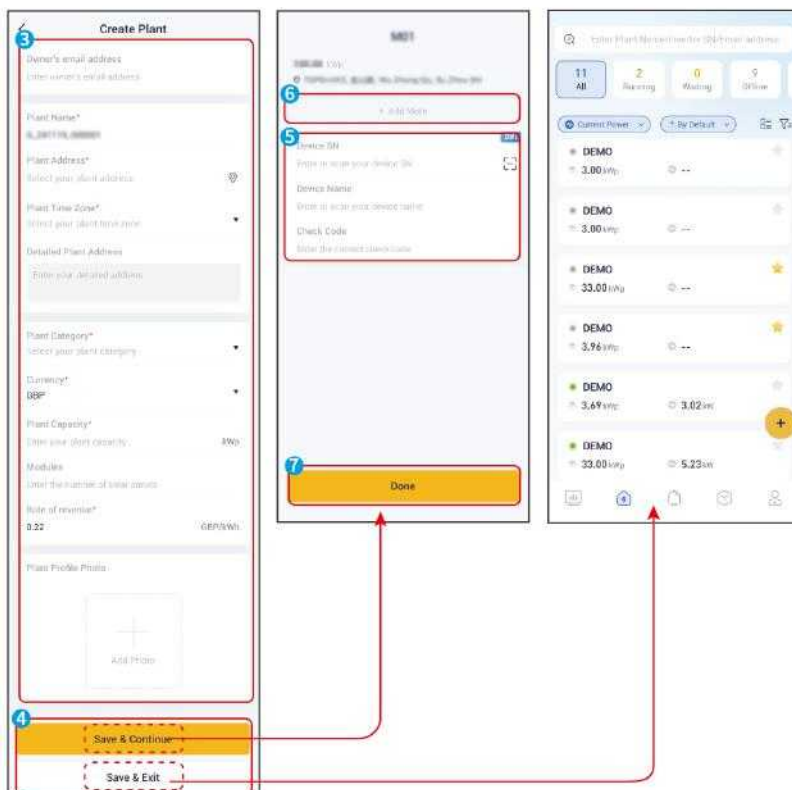

8 System Commissioning

8.1 Commissioning Method Overview

Please use the SolarGo App to configure the parameters.

8.2 SolarGo APP

8.2.1 Product Introduction

NOTICE

- All the user interface (UI) screenshots or words in this document are based on **SolarGo app V6.6.0**. The UI may be different due to the version upgrade. The screenshots, words or data are for reference only.
- The method to set parameters is the same for all inverters. But the parameters displayed varies based on the equipment model and safety code. Refer to the actual interface display for specific parameters.
- Before setting any parameters, read through user manual of the App and the inverter or charger to learn the product functions and features. When the inverter parameters are set improperly, the inverter may fail to connect to the utility grid or fail to connect to the utility grid in compliance with related requirements and damage the battery, which will affect the inverter's power generation.

SolarGo App is a mobile application that communicates with the inverter via Bluetooth, WiFi, 4G, or GPRS. Commonly used functions are as follows:

- Check the operating data, software version, alarms of the inverter, etc.
- Set grid parameters and communication parameters of the inverter.
- Set charging mode of the charger.
- Maintain the equipment.

8.2.1.1 Downloading and Installing the App

Make sure that the mobile phone meets the following requirements:

- Mobile phone operating system: Android 5.0 or later, iOS 13.0 or later.
- The mobile phone can access the Internet.
- The mobile phone supports WLAN or Bluetooth.

NOTICE

After installing the app, it can automatically prompt users to update the app version.

Method 1: Search SolarGo in Google Play (Android) or App Store (iOS) to download and install the app.

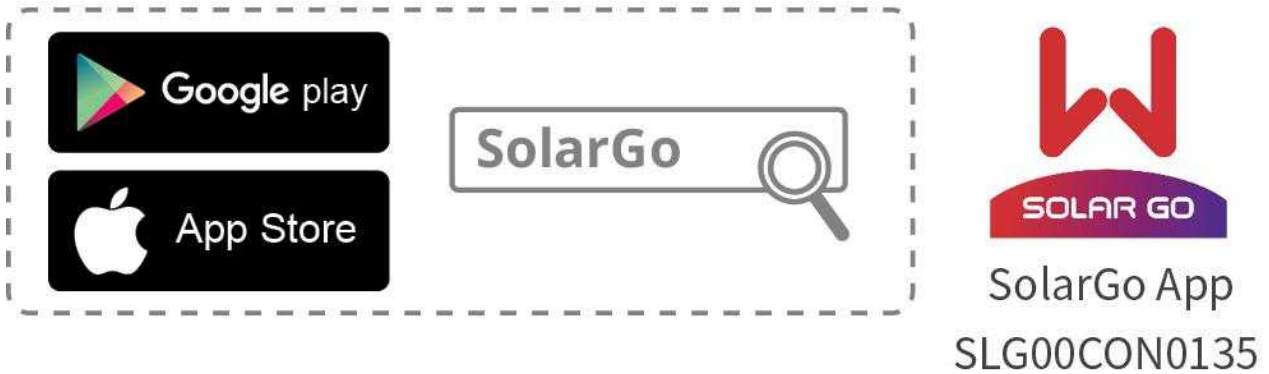

Method 2: Scan the QR code below to download and install the app.

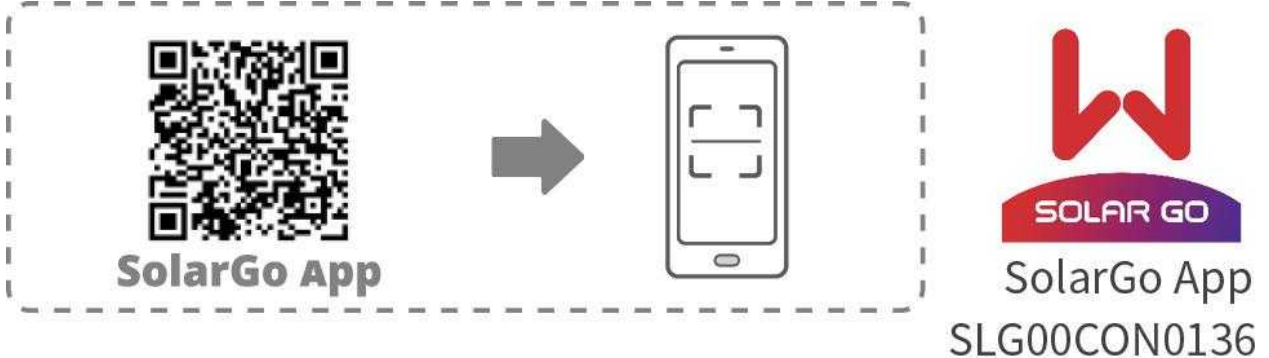

8.2.1.2 App Connection

Connect as the following shows after powering on the equipment.

NOTICE

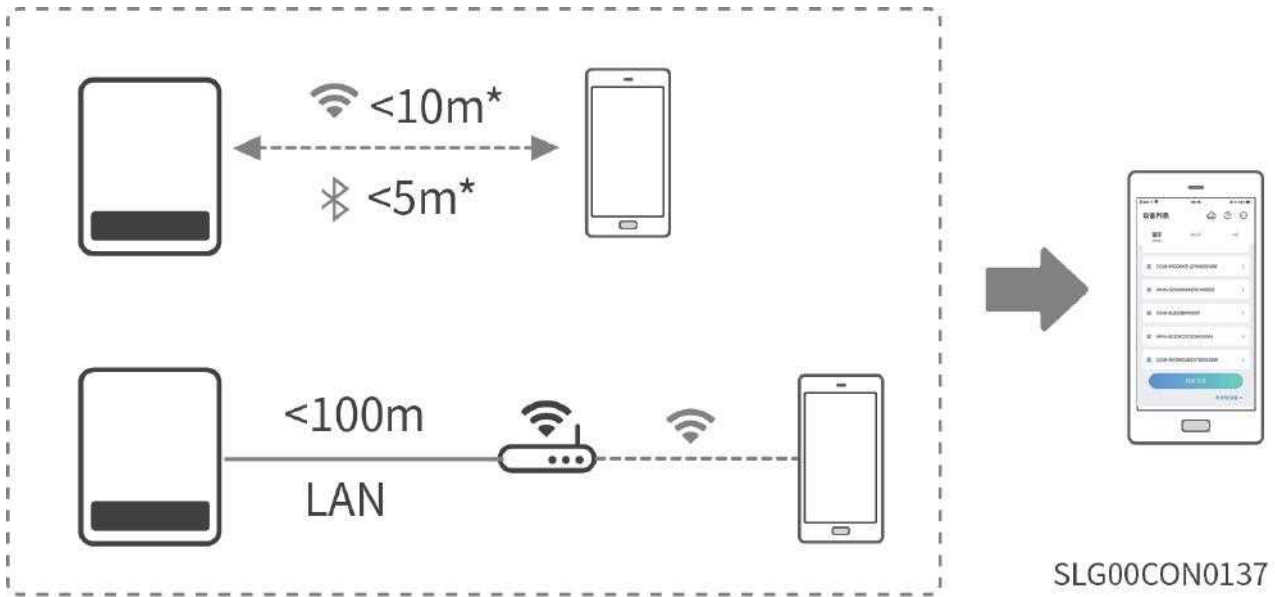

The connection distance varies depending on smart dongles. Refer to the actual used smart dongles.

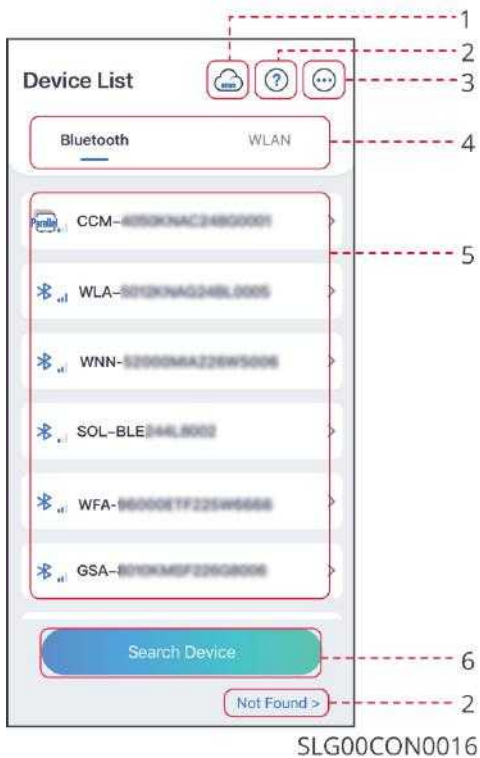

8.2.1.3 GUI Introductions to Login Page



No.	Name/Icon	Description
1		Tap the icon to open the page downloading the SEMS Portal app.

No.	Name/Icon	Description
2		Tap to read the connection guide.
	Not found	
3		<ul style="list-style-type: none"> • Check information such as app version, local contacts, etc. • Other settings, such as update date, switch language, set temperature unit, etc.
4	Bluetooth/WiFi/4G	Select based on actual communication method. If you have any problems, tap  or NOT Found to read the connection guides.
5	Device List	<ul style="list-style-type: none"> • The list of all devices. The last digits of the device name are normally the serial number of the device. • Select the device by checking the serial number of the master inverter when multi inverters are parallel connected. • The device name varies depending on the inverter model or smart dongle model: <ul style="list-style-type: none"> ◦ Wi-Fi/LAN Kit, Wi-Fi Kit, Wi-Fi Box: Solar-WiFi*** ◦ External or integrated bluetooth module: Solar-BLE*** ◦ WiFi/LAN Kit-20: WLA-*** ◦ WiFi Kit-20: WFA-*** ◦ Ezlink3000: CCM-BLE***; CCM-***; *** ◦ 4G Kit-CN-G20/4G Kit-CN-G21: GSA-***; GSB-*** ◦ 4G Kit-G20: GSC-*** ◦ Micro inverter: WNN*** ◦ AC Charger: ***
6	Search Device	Tap Search Device if the device is not found.

8.2.2 Connecting the Hybrid Inverter (Bluetooth)

Step 1 Ensure that the inverter is power on, both the inverter and the communication module are working properly.

Step 2 Select **Bluetooth** tab on the SolarGo app homepage.

Step 3 Pull down or tap **Search Device** to refresh the device list. Find the device by the the inverter serial number. Tap the device name to log into the **Home** page. Select the device by checking the serial number of the master inverter when multi inverters are parallel connected.

Step 4 For first connection with the equipment via Bluetooth, there will be a Bluetooth pairing prompt, tap **Pair** to continue the connection.

Step 5 Log in as an Owner or an Installer. Initial password: 1234. Default password: 1234.

Step 6 (Optional): If connecting via WLA-*** or WFA-***, enable Bluetooth Stays On following the prompts as entering the device details page. Otherwise, the bluetooth signal of the device will be off after disconnection.

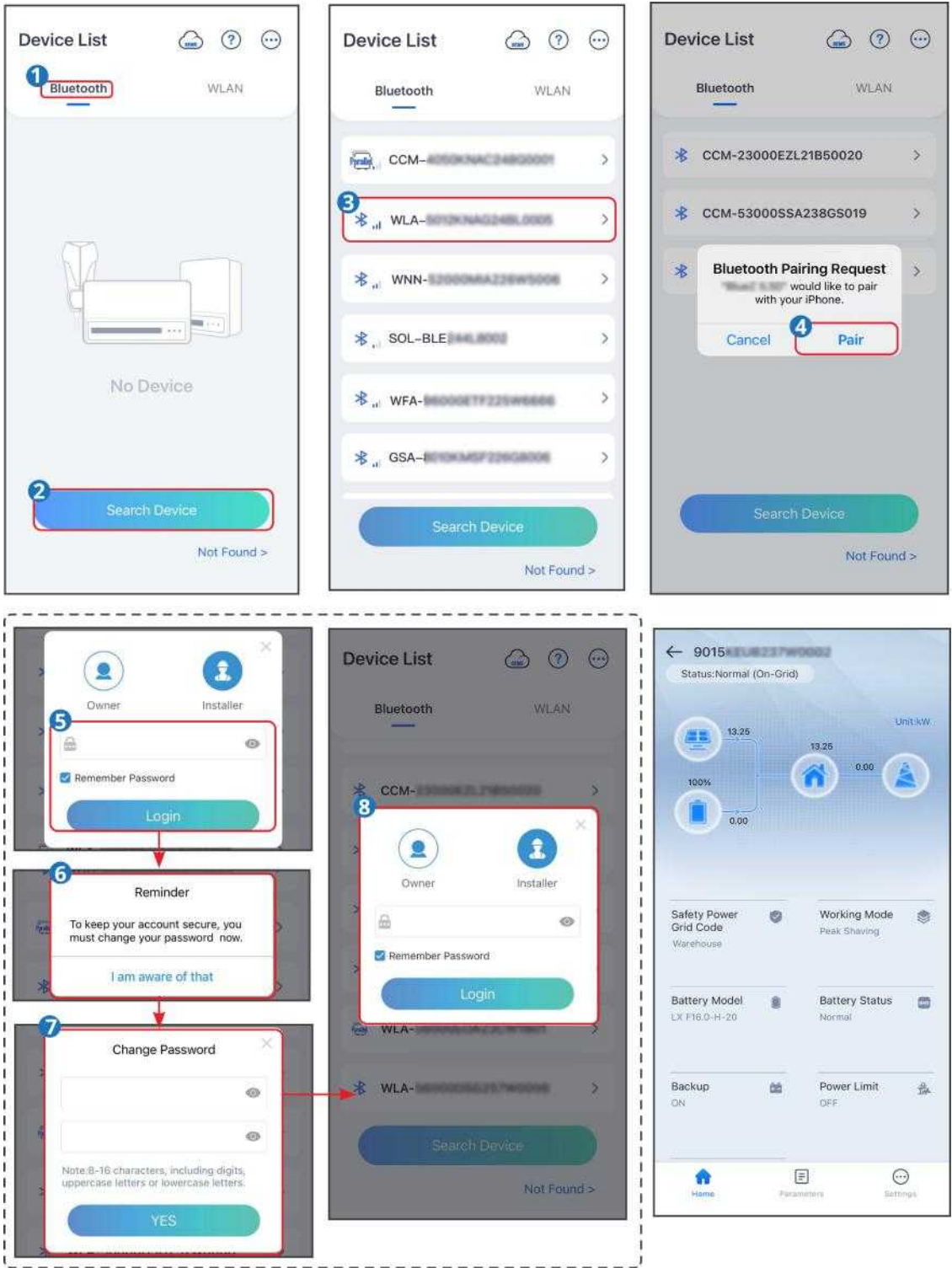

8.2.3 Connect the Smart Dongle

When connecting to an inverter via the SolarGo App, if the inverter signal cannot be detected, the device list interface will display the signal of the smart dongle connected to the inverter.

Supported Smart Dongle types:

- WiFi/LAN Kit-20
- Ezlink3000
- 4G Kit-CN-G20 ; 4G Kit-CN-G21 ; 4G Kit-G20

Step 1: On the homepage of the SolarGo App, find the grayed-out SN number of the smart dongle and click to enter the settings interface.

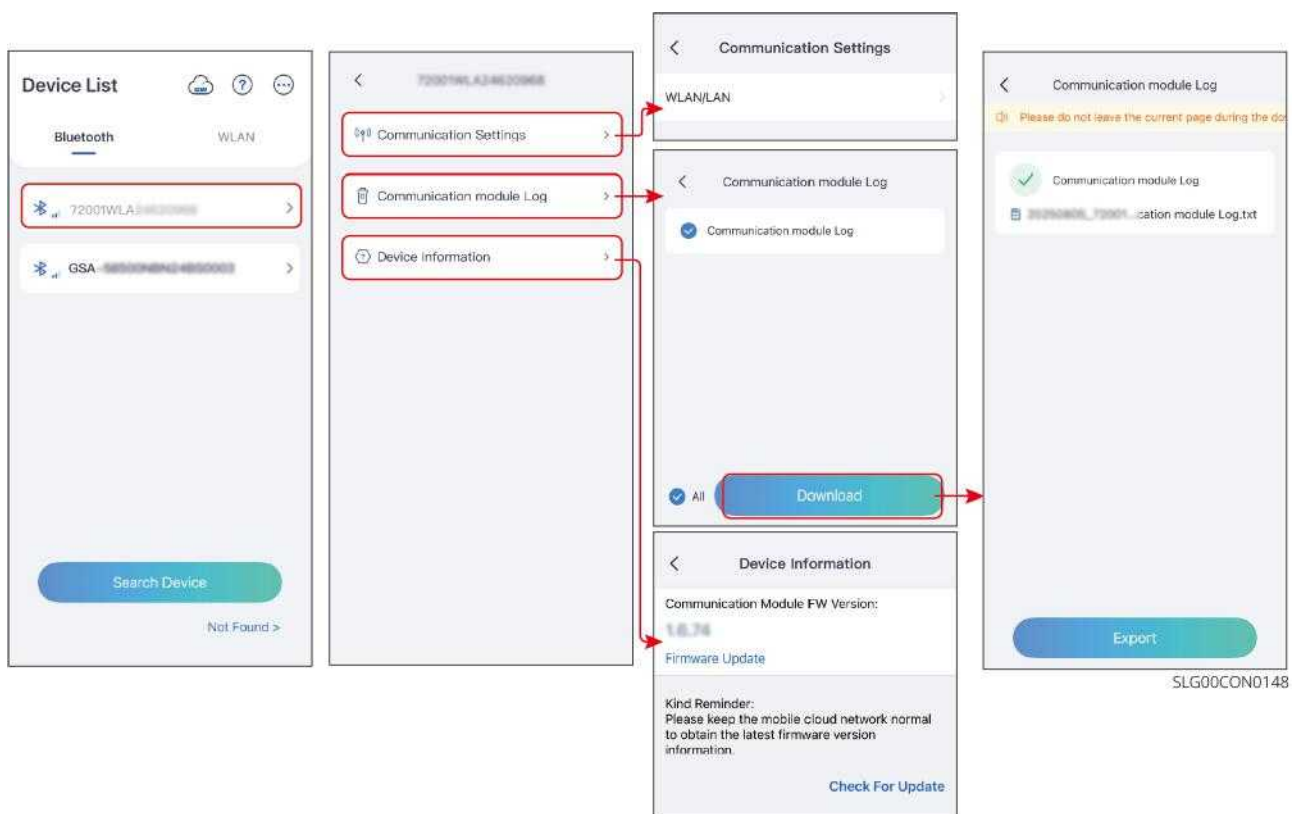

Step 2: Set or query parameter information according to actual needs.

- Communication Configuration: Click to set WLAN/LAN parameters and connect the module to the router.
- Communication Module Logs: Click to enter the module log download interface.
- Device Information: Click to view the firmware version of the smart dongle. If a version update is available, you can refer to the on-screen prompts to complete the update.

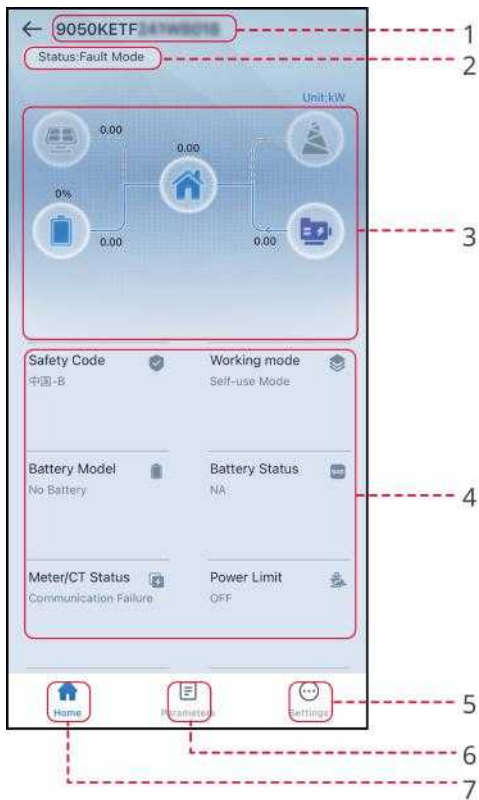

8.2.4 GUI Introductions to Hybrid Inverters



No.	Name/Icon	Description
1	Serial Number	Serial number of the connected inverter.
2	Device Status	Indicates the status of the inverter, such as Working, Fault, etc.
3	Energy Flow Chart	Indicates the energy flow chart of the PV system. The actual page prevails.
4	System Status	Indicates the system status, such as Safety Code, Working Mode, Battery Model, Battery Status, Power Limit, Three-Phase Unbalanced Output, etc..
5		Home. Tap Home to check Serial Number, Device Status, Energy Flow Chart, System Status, etc.
6		Parameters. Tap Parameters to check the inverter Data.

No.	Name/Icon	Description
7		<ul style="list-style-type: none"> • Settings Tap to perform quick settings, basic settings, advanced settings, etc. on the inverter. • Login required to access Quick Setup and Advanced Setting. Contact the supplier or after sales service for password. Password for professional technicians only.

8.2.5 Setting Communication Parameters

NOTICE

The communication configuration interface may be different if the inverter uses different communication modes or connects different communication modules. Please refer to the actual interface.

8.2.5.1 Setting Privacy and Security Parameters

Type I

Step 1 : Tap **Home** > **Settings** > **Communication Setting** > **Privacy & Security** to set the parameters.

Step 2 : Set the new password for the WiFi hotspot of the communication module, and tap **Save**.

Step 3 Open the WiFi settings of your phone and connect to the inverter's WiFi signal (Solar WiFi***) with the new password.

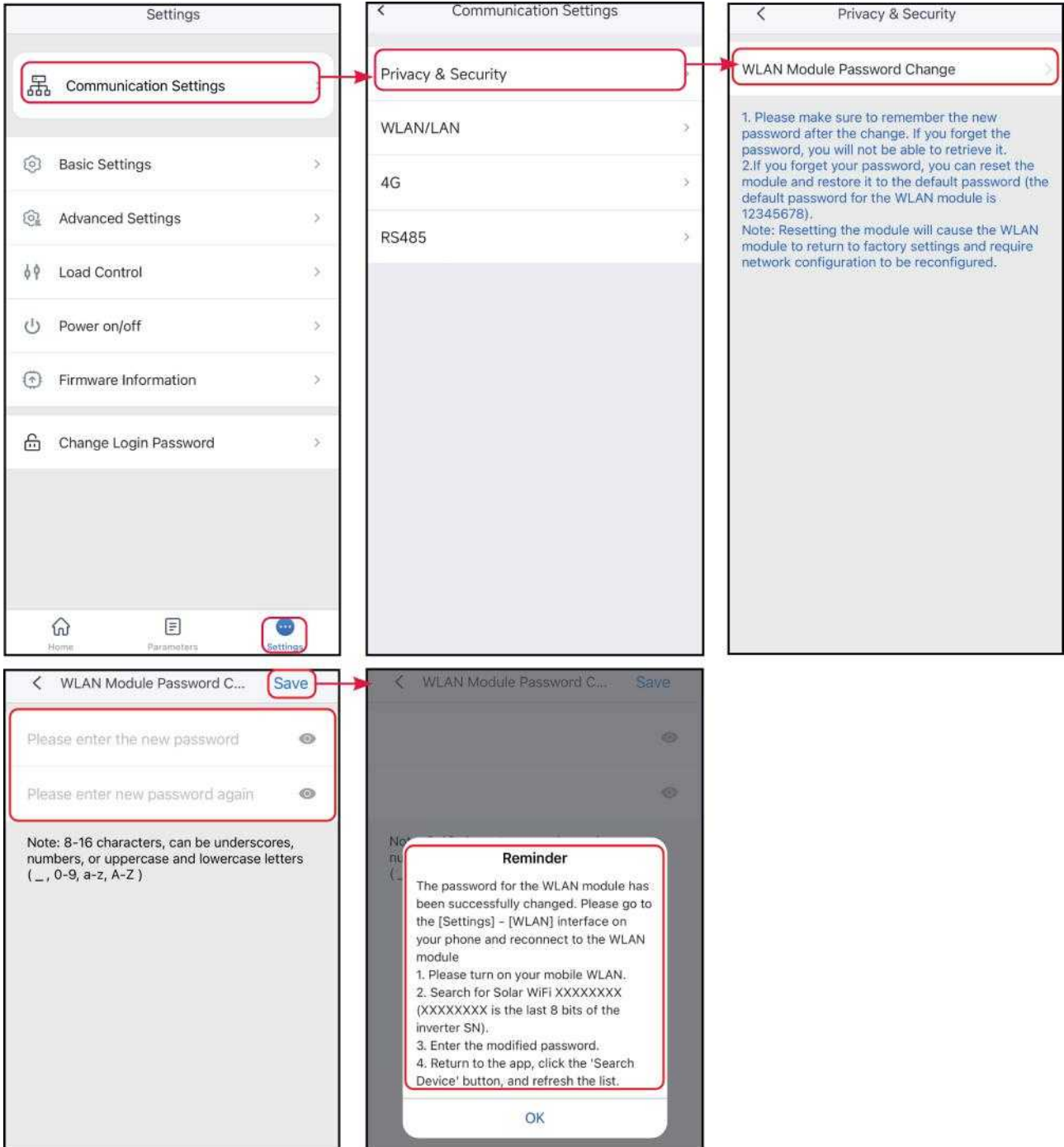

Type II

Step 1 : Tap **Home > Settings > Communication Setting > Privacy & Security** to set the parameters.

Step 2 Enable Bluetooth Stays On or WLAN Control based on actual needs.

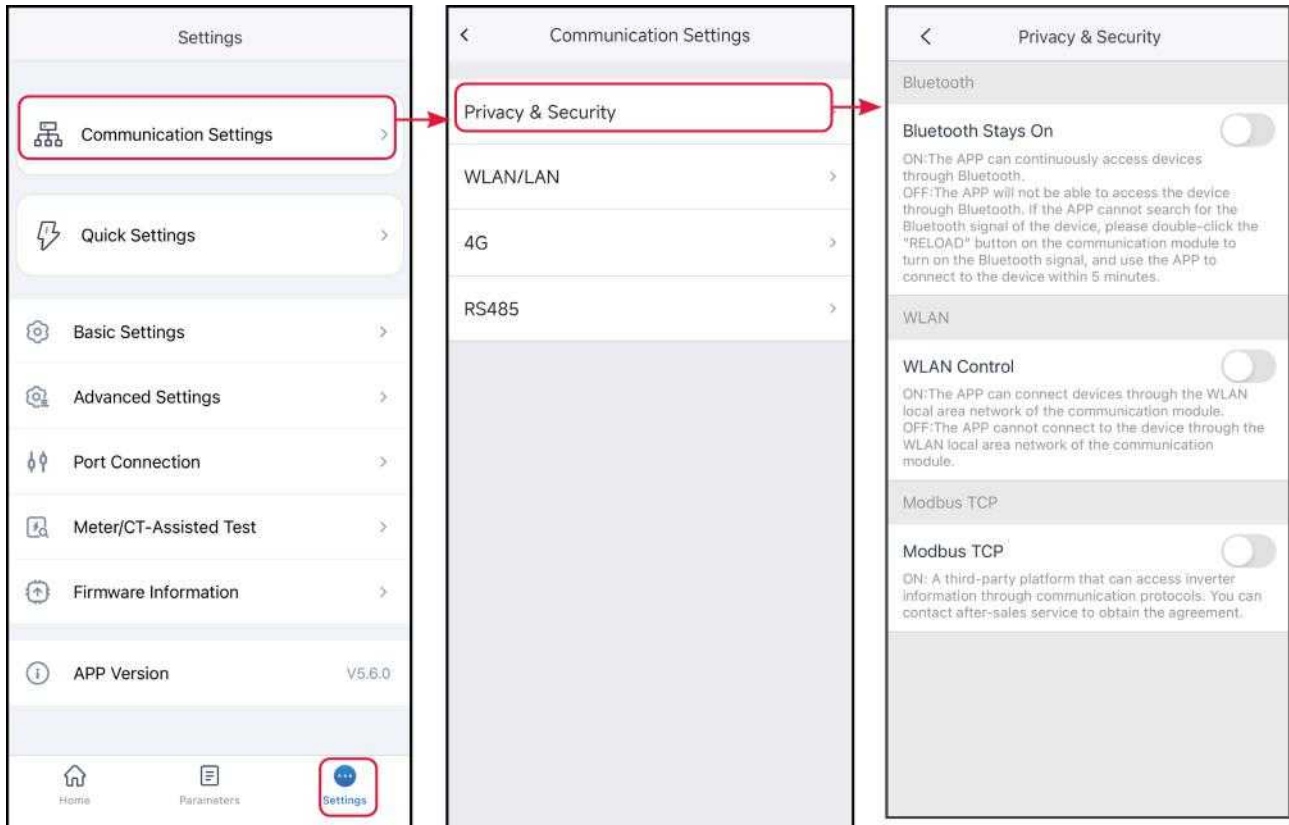

No.	Parameters	Description
1	Bluetooth Stays On	Disabled by default. Enable the function, the bluetooth of the device will be contentious on to keep connected to SolarGo. Otherwise, the bluetooth will be off in 5 minutes, and the device will be disconnected from SolarGo.
2	WLAN Control	Disabled by default. Enable the function, the device and the SolarGo can be connected through the WLAN when they are on the same LAN. Otherwise, they cannot be connected even if they are on the same LAN.
3	Modbus-TCP	Enable the function, the third party monitoring platform can access inverter through Modbus-TCP communication protocol.
4	SSH control Ezlink	After enabling this function, third-party platforms can connect to and control EzLink's Linux system.

Type III

Step 1 : Tap **Home > Settings > Communication Setting > Privacy & Security** to set

the parameters.

Step 2 : Enable **Bluetooth Stays On** or **Login Password** based on actual needs.

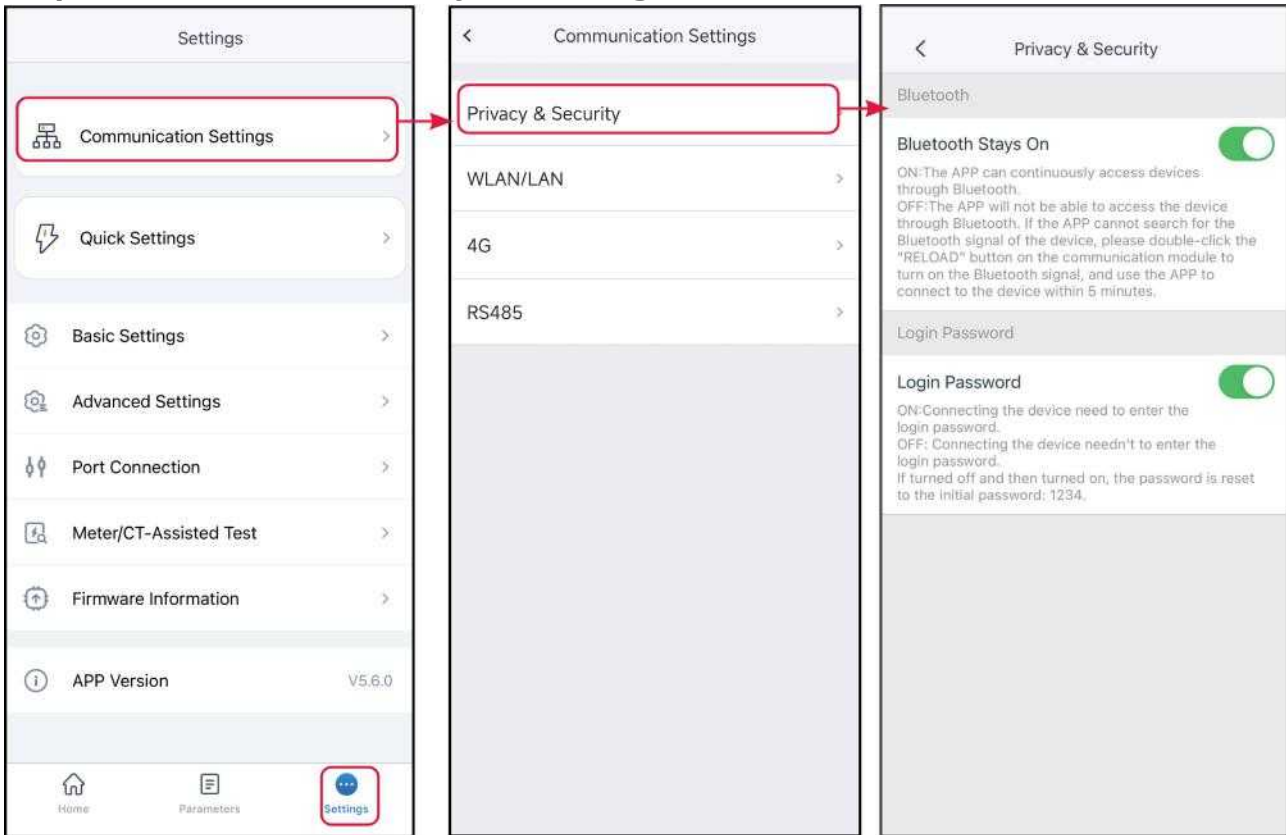

No.	Parameters	Description
1	Bluetooth Stays On	Disabled by default. Enable the function, the bluetooth of the device will be contentious on to keep connected to SolarGo. Otherwise, the bluetooth will be off in 5 minutes, and the device will be disconnected from SolarGo.
2	Password	Disabled by default. Enable the function, you will be prompted to enter the login password when connecting the device to SolarGo. Use the initial password and change it at the first login prompt.

8.2.5.2 Setting WLAN/LAN Parameters

NOTICE

When the inverter is connected to different communication modules, the communication configuration interface may be different. Please refer to the actual interface.

Step 1 : Tap **Home > Settings > Communication Setting > WLAN/LAN** to set the parameters.

Step 2 : Configure the WLAN or LAN parameters based on actual needs.

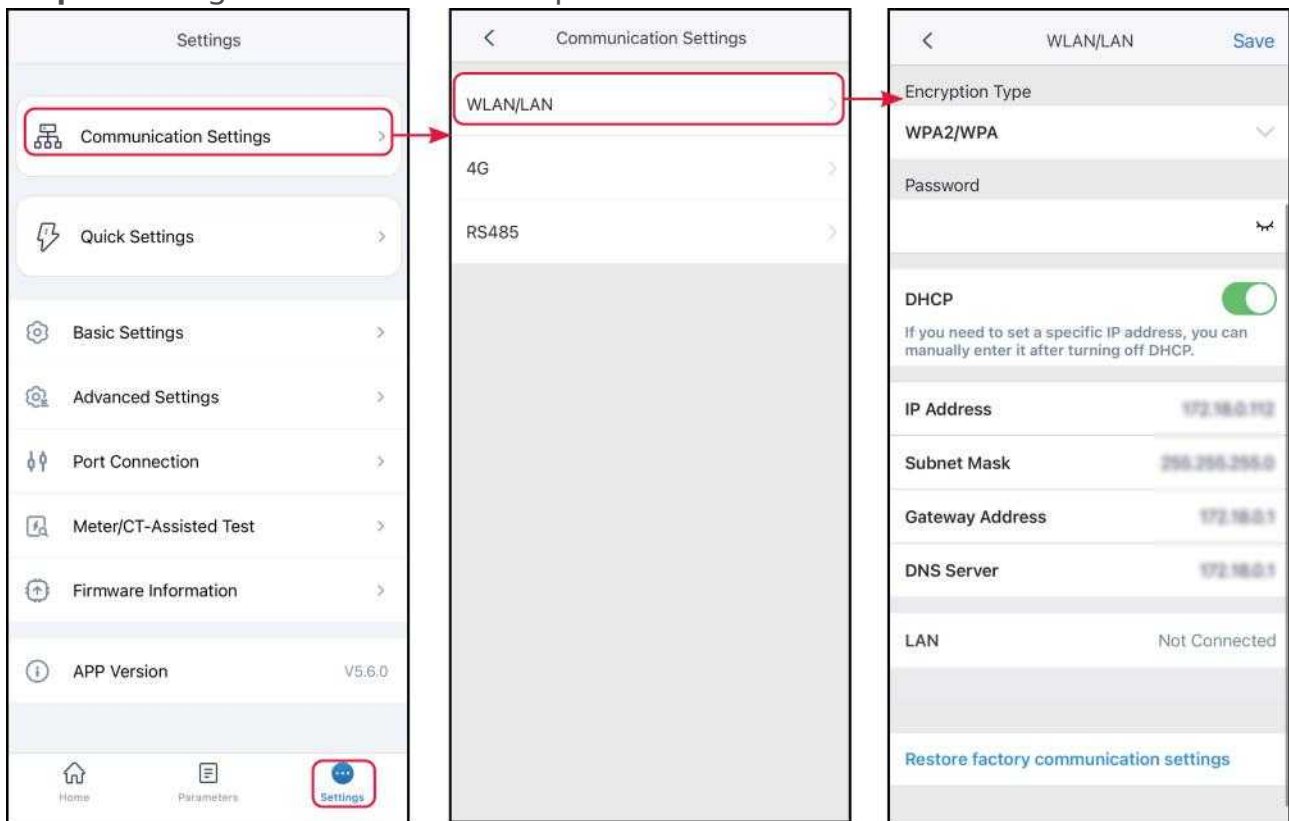

No.	Parameters	Description
1	Network Name	Only for WLAN. Select WiFi based on the actual connecting.
2	Password	Only for WLAN. WiFi password for the actual connected network.
3	DHCP	Enable DHCP when the router is in dynamic IP mode. Disable DHCP when a switch is used or the router is in static IP mode.

No.	Parameters	Description
4	IP Address	Do not configure the parameters when DHCP is enabled. Configure the parameters according to the router or switch information when DHCP is disabled.
5	Subnet Mask	
6	Gateway Address	
7	DNS Server	

8.2.5.3 Configuring RS485 Parameters

NOTICE

Set the communication address of the inverter. For a single inverter, the address is set based on actual needs. For multi connected inverters, the address of each inverter should be different while cannot be 247.

Step 1: Tap **Home > Settings > Communication Settings > RS485** to set the parameters.

Step 2 : Set the Modbus Address And Baud Rate base on actual situation.

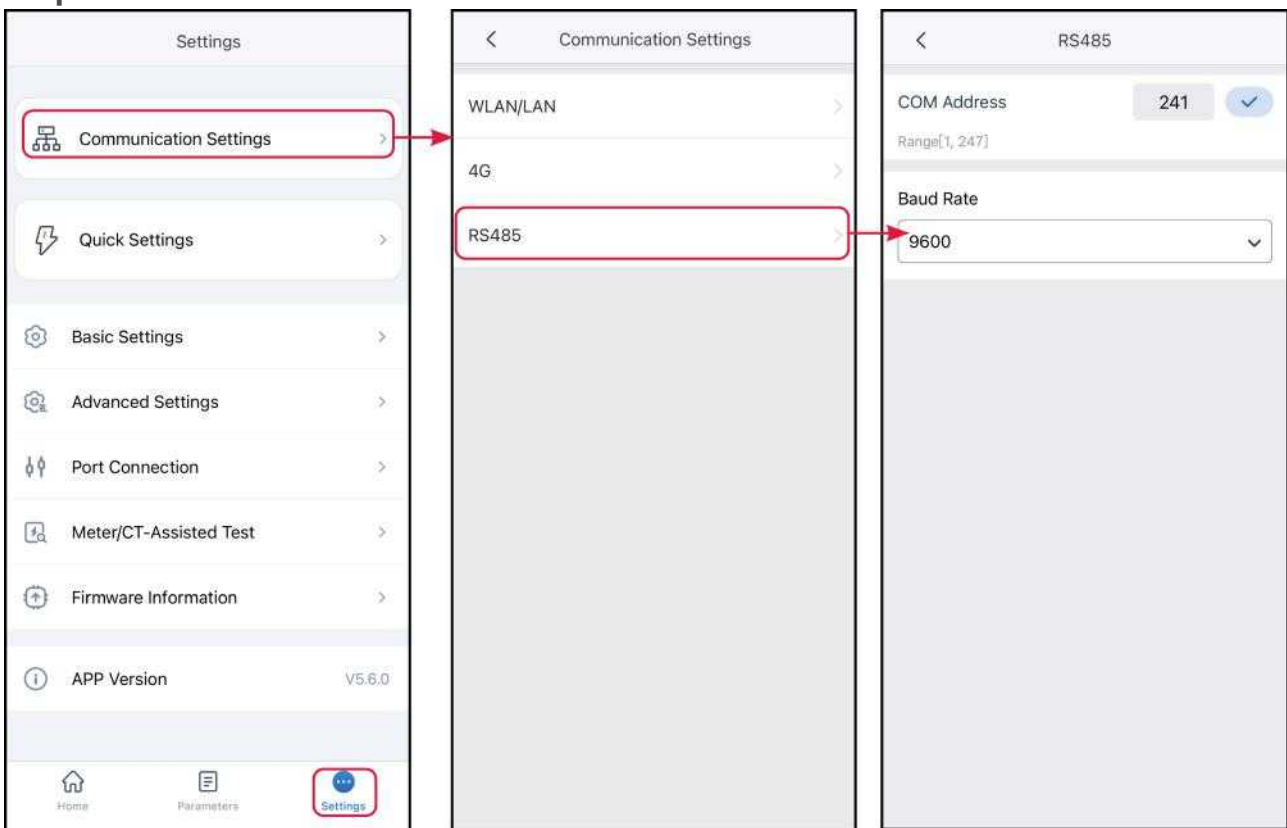

8.2.6 Setting Up the RS485 Parallel System

NOTICE

- When paralleling hybrid inverters via RS485, you must set each inverter as the master or slave inverter individually using the SolarGo App.
- When an inverter in a parallel system needs to be used as a single unit, it must be set to standalone inverter via the SolarGo App.
- Please set the inverter connected to the meter as the master.
- Please first set the slave inverter address, then set the parallel network through the master.

Step 1: Go to the settings interface via **Settings > Parallel System Settings** .

Step 2: Set the inverter to Master, Slave, or Stand-alone based on its actual wiring.

- If the inverter is the master, set it to Master and then exit the connection. After setting the slave inverter address, return to this interface, click **Parallel Networking**, set the number of inverters in the parallel system, and then click **Network**.
- If the inverter is the slave, set the **Inverter Address** and click ✓.

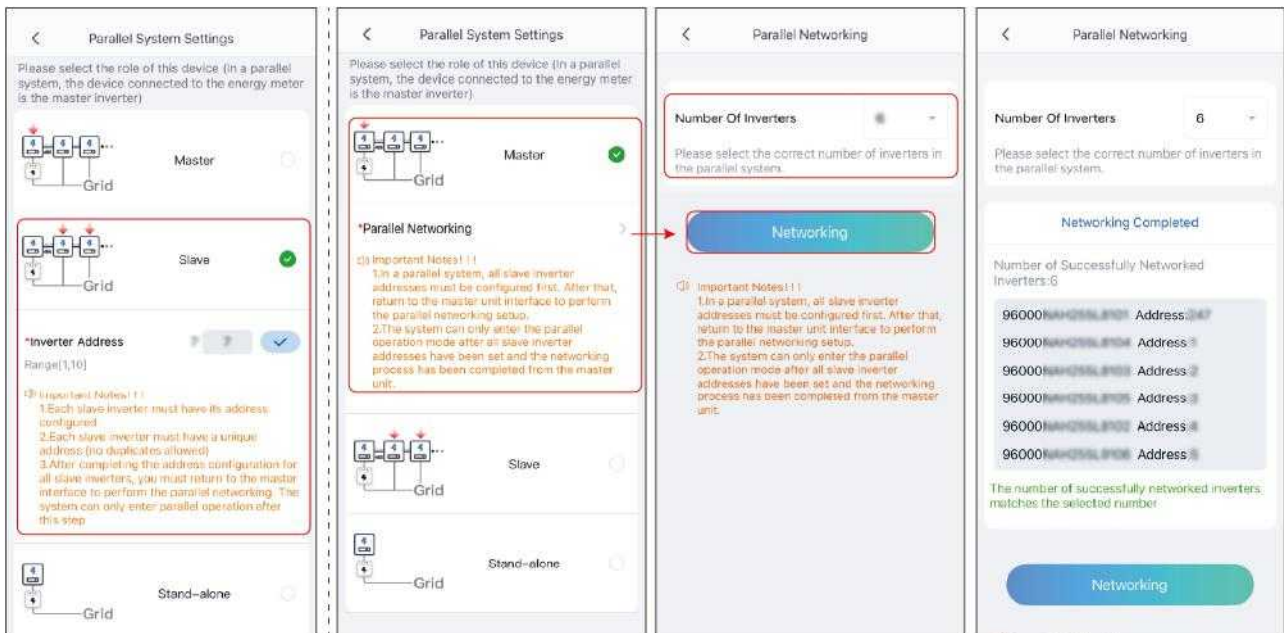

SLG00CON0188

8.2.7 Quick Setting the Basic Information

NOTICE

- The setting page varies depending on inverter model.
- The parameters will be configured automatically after selecting the safety country/region, including overvoltage protection, undervoltage protection, overfrequency protection, underfrequency protection, voltage/frequency connection protection, $\cos\phi$ curve, Q(U) curve, P(U) curve, FP curve, HVRT, LVRT, etc. Tap Home > Settings > Advanced Settings > Safety Parameters to check the parameters after selecting the safety country.
- The power generation efficiency is different in different working modes. Set the working mode according to the local requirements and situation.
 - Self-use mode: The basic working mode of the system. PV power generation is used to supply power to the load first, the excess power is used to charge the battery, and the remaining power is sold to the grid. When PV power generation cannot meet the load's power demand, the battery will supply power to the load; when the battery power also cannot meet the load's power demand, the grid will supply power to the load.
 - Back-up mode: The back-up mode is mainly applied to the scenario where the grid is unstable. When the grid is disconnected, the inverter turns to off-grid mode and the battery will supply power to the load; when the grid is restored, the inverter switches to grid-tied mode.
 - Economic mode: It is recommended to use economic mode in scenarios when the peak-valley electricity price varies a lot. Select Economic mode only when it meets the local laws and regulations. Set the battery to charge mode during Vally period to charge battery with grid power. And set the battery to discharge mode during Peak period to power the load with the battery.
 - Off-grid mode: suitable for areas without power grid. PV and batteries form a pure off-grid system. PV generates electricity to power the load and excess electricity charges the battery. When PV power generation cannot meet the power demand of the load, the battery will supply power to the load.
 - Smart charging: In some countries/regions, the PV power feed into the utility grid is limited. Select Smart Charging to charge the battery using the surplus power to minimize PV power waste.
 - Peak shaving mode: Peak shaving mode is mainly applicable to peak power limited scenarios. When the total power consumption of the load exceeds the power consumption quota in a short period of time, battery discharge can be used to reduce the power exceeding the quota.

8.2.7.1 Quick Setting the Basic Information(Type I)

Step 1: Tap **Home** > **Settings** > **Quick Settings** to set the parameters.

Step 2 : Enter the password for quick settings. Contact the supplier or after sales service for password. Password for professional technicians only.

Step 3 : Some models support one-click configuration. Select **Guided Mode** to quickly configure the system.

Step 4: Select Grid Code(Safety Code)accordingly. Tap **Next** to set the Working Mode.

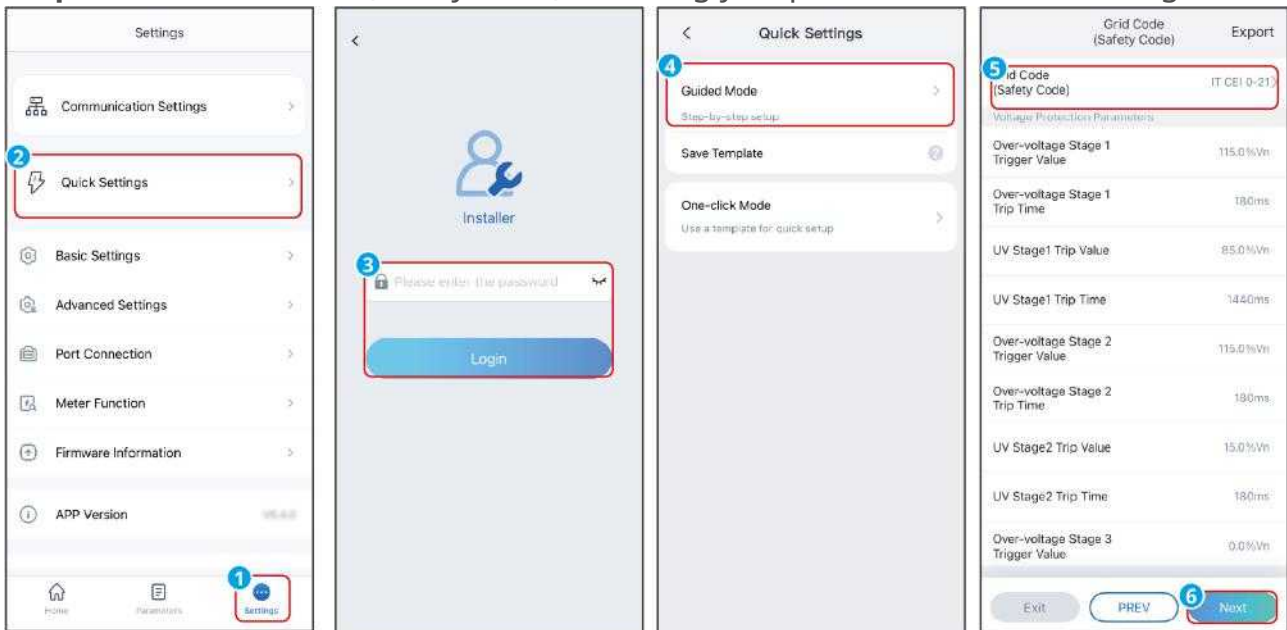

Step 5: Set the working mode based on actual needs. Tap **Next** to set the Working Mode. For some models, after the working mode configuration is completed, it will automatically enter the CT/meter self-test state. At this time, the inverter will temporarily disconnect from the grid and then automatically reconnect.

Step 6 : Select the battery based on actual situation whether it is **First Installation**, **Routine Operation** or **Replacement Installation**.

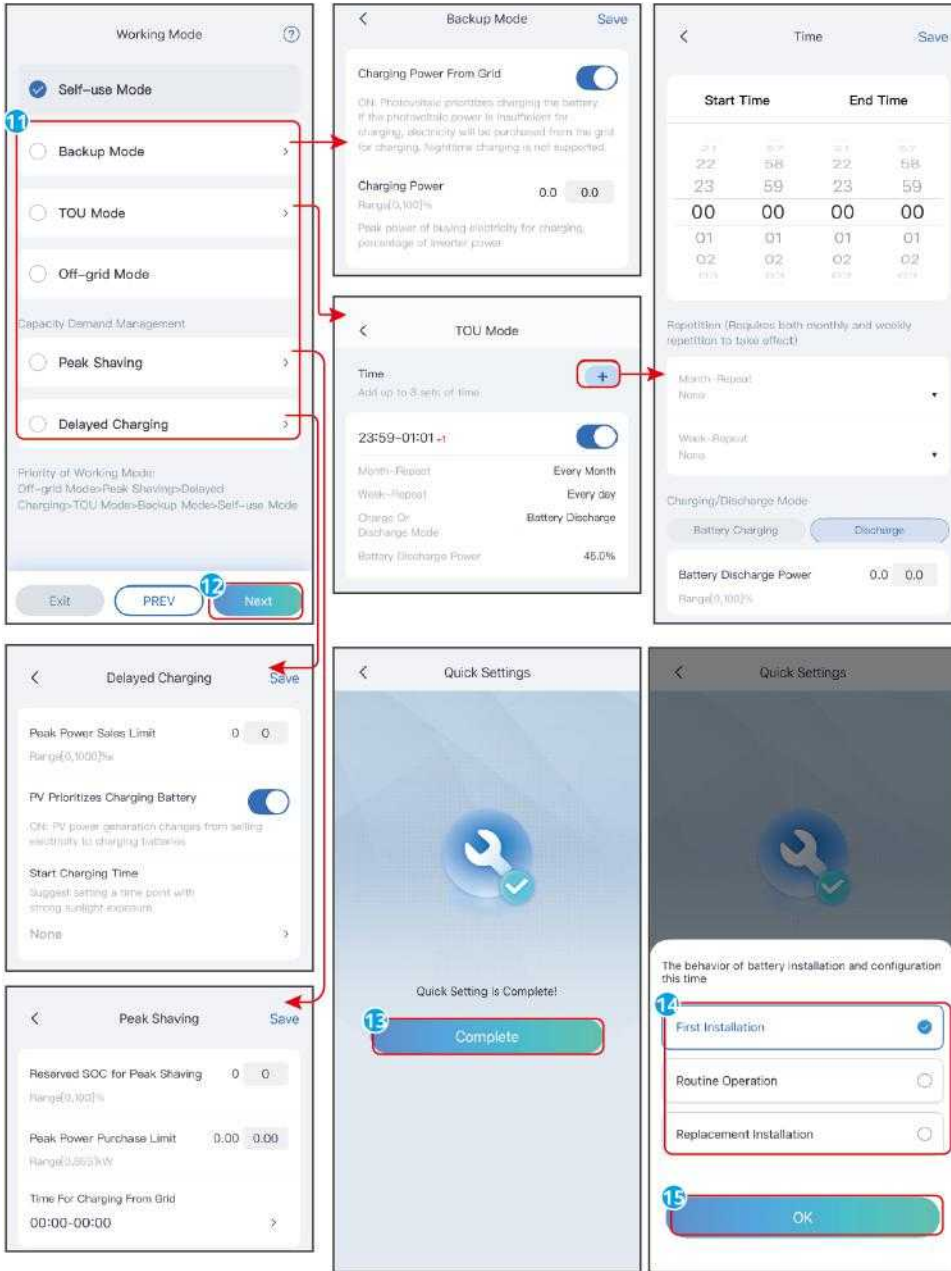

SLG00CON0060

No.	Parameters	Description
Back-up mode		
1	Charging Power From Grid	Enable Charging Power From Grid to allow power purchasing from the utility grid.
2	Charging Power	The percentage of the purchasing power to the rated power of the inverter.
TOU mode		

No.	Parameters	Description
3	Start Time	Within the Start Time and End Time, the battery is charged or discharged according to the set Battery Mode as well as the Rated Power.
4	End Time	
5	Charge Discharge Mode	Charge or discharge according to actual needs.
6	Rated Power	The percentage of the charging/discharging power to the rated power of the inverter.
7	Charge Cut-off SOC	The battery stop charging/discharging once the battery SOC reaches Charge Cut-off SOC.
Peakshaving		
8	Reserved SOC For Peakshaving	In Peak Shaving mode, the battery SOC should be lower than Reserved SOC For Peakshaving. Once the battery SOC is higher than Reserved SOC For Peakshaving, the peak shaving mode fails.
9	Peak Power Purchase Limit	Set the maximum power limit allowed to purchase from the grid. When the loads consume power exceed the sum of the power generated in the PV system and Peak Power Purchase Limit, the excess power will be made up by the battery.
10	Time for Charging From Grid	The utility grid will charge the battery between Start Time and End Time if the load power consumption do not exceed the power quota. Otherwise, only PV power can be used to charge the battery. Otherwise, only PV power can be used to charge the battery.
Smart charging		
11	Peak Power Sales Limit	Set the Peak Power Sales Limit in compliance with local laws and regulations. The Peak Limiting Power shall be lower then the output power limit specified by local requirements.
12	PV Prioritizes Charing Battery	During charging time, the PV power will first charge the battery.

No.	Parameters	Description
13	Start Charging Time	

Step 7 : For devices that support one-click configuration, a template can be generated based on the completed configuration.

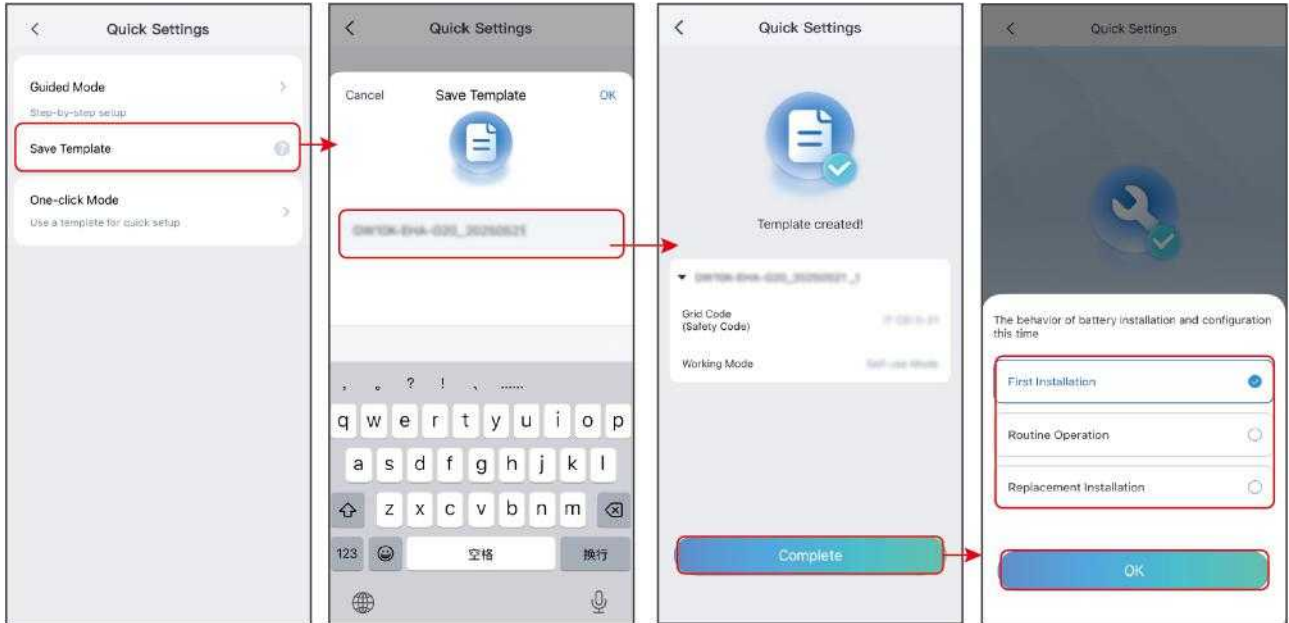

SLG00CON0119

Step 8: If you already have a one-click configuration template, you can use the existing template direct import mode to quickly complete the configuration.

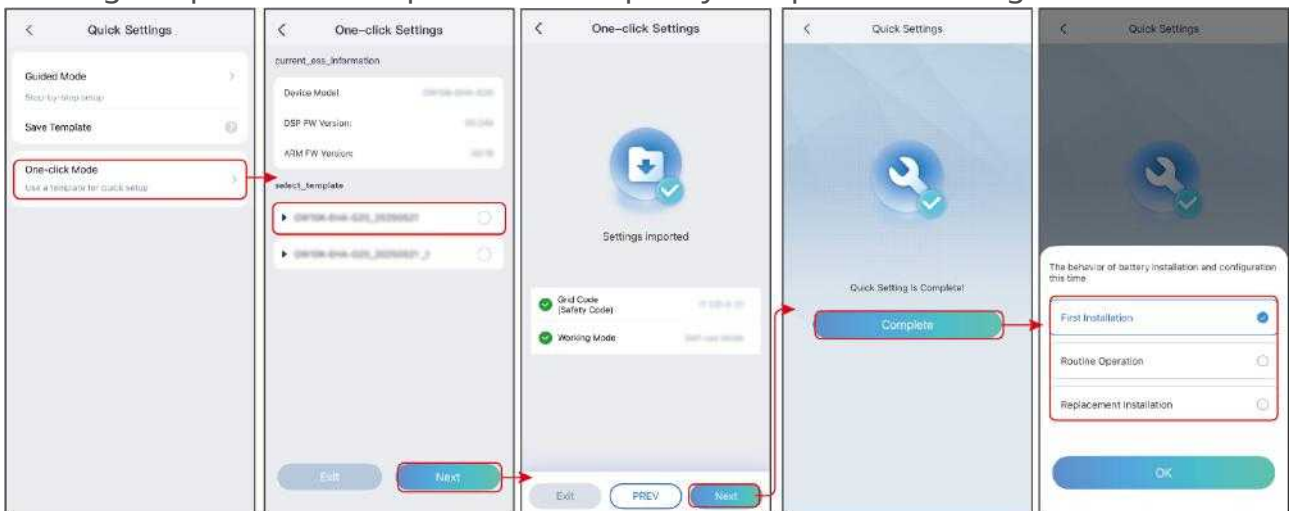

SLG00CON0120

8.2.8 Setting the Basic Information

8.2.8.1 Setting the SPD

After enabling SPD, when the SPD module is abnormal, there will be SPD module abnormal alarm prompt.

Step 1 : Tap **Home > Settings > Basic Settings > SPD**, to set the parameters.

Step 2 : enable or disable the function based on actual needs.

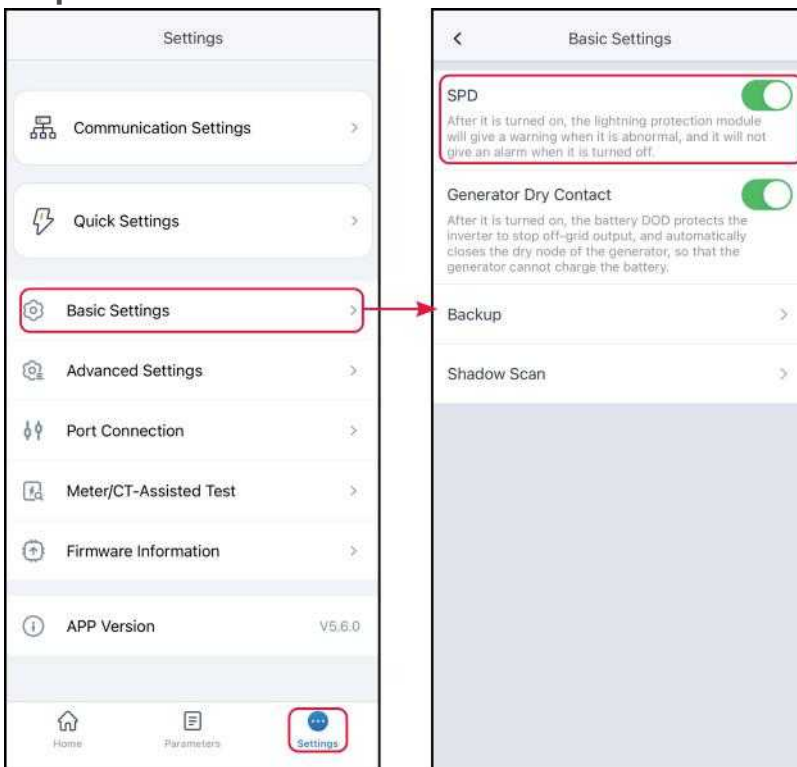

8.2.8.2 Setting the Back-up Power Parameters

After enabling Backup, the battery will power the load connected to the backup port of the inverter to ensure Uninterrupted Power Supply when the power grid fails.

Step 1 : Tap **Home > Settings > Basic Settings > Backup**, to set the parameters.

Step 2 : Set the backup supply function based on actual needs.

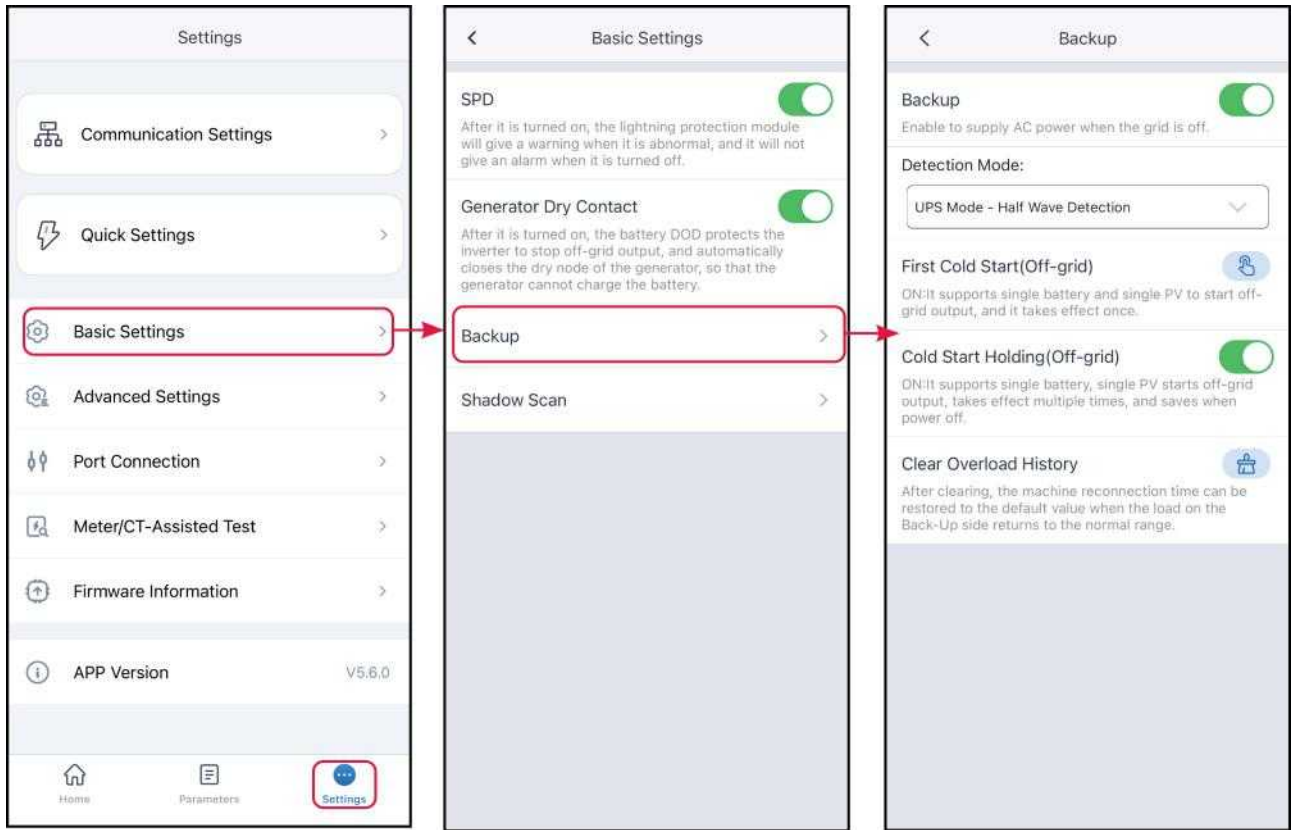

No.	Parameters	Description
1	UPS Mode- Full Wave Detection	Check whether the utility grid voltage is too high or too low.
2	UPS Mode- Half Wave Detection	Check whether the utility grid voltage is too low.
3	EPSmode-with LVRT support.	Stop detecting utility grid voltage.
4	First Cold Start (Off-grid)	It will only take effect once. In off-grid mode, enable First Cold Start (Off-grid) to output backup supply with battery or PV.
5	Cold Start Holding (Off-grid)	Take effect multiple times. In off-grid mode, enable First Cold Start (Off-grid) to output backup supply with battery or PV.

No.	Parameters	Description
6	Clear Overload History	Once the power of loads connected to the inverter BACK-UP ports exceeds the rated load power, the inverter will restart and detect the power again. The inverter will perform restart and detection several times until the overloading problem is solved. Tap Clear Overload History to reset the restart time interval after the power of the loads connected to the BACK-UP ports meets the requirements. The inverter will restart immediately.

8.2.8.3 Setting the Shadow Scan

Enable Shadow Scan when the PV panels are severely shadowed to optimize the power generation efficiency.

Step 1 : Tap **Home > Settings > Basic Settings> Shadow Scan**, to set the parameters.

Step 2: Enable or disable the function based on actual needs. Set the Shadow Scan interval and MPPT shadow scan if the inverter supports.

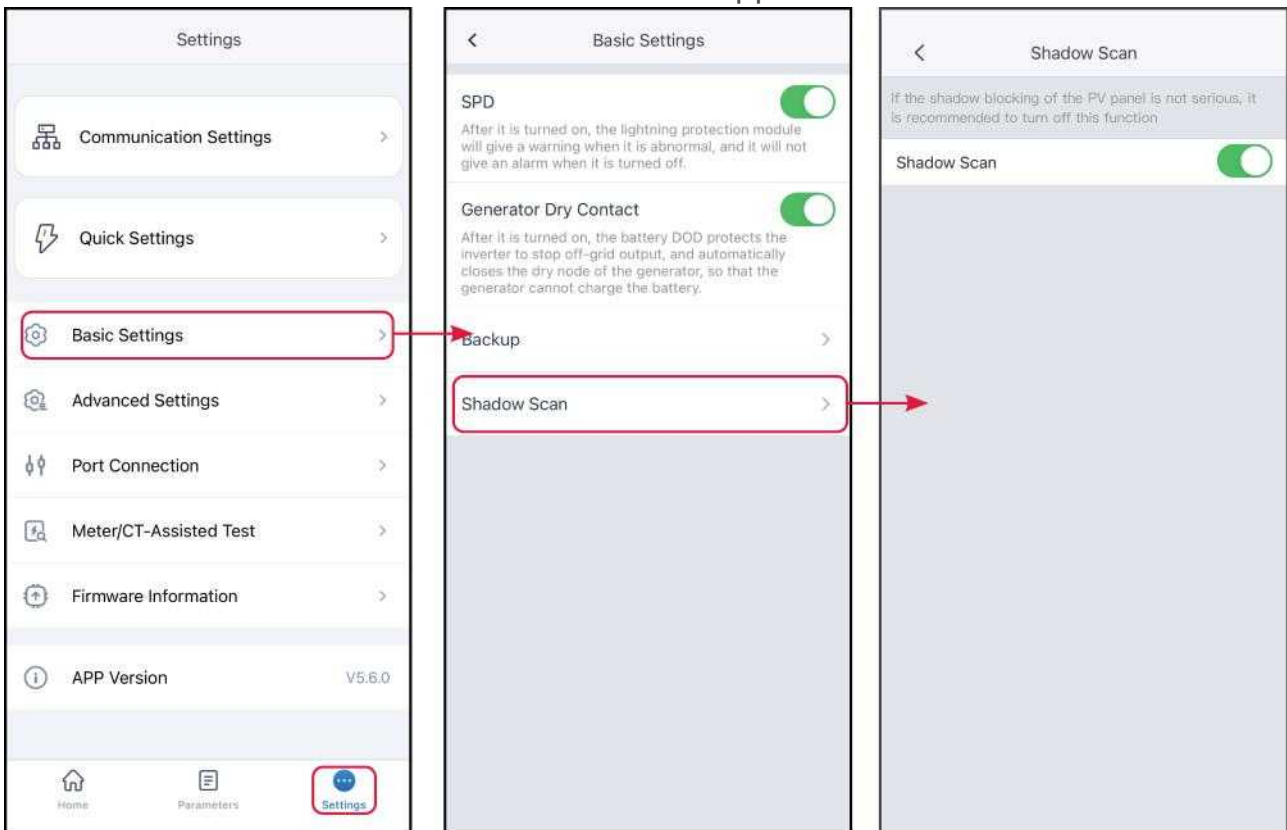

8.2.8.4 Setting Power Adjustment Parameters

Step 1: Go to the settings interface via **Home > Settings > Basic Settings > Power Scheduling**.

Step 2: Set the active power dispatch or reactive power dispatch parameters according to the actual situation.

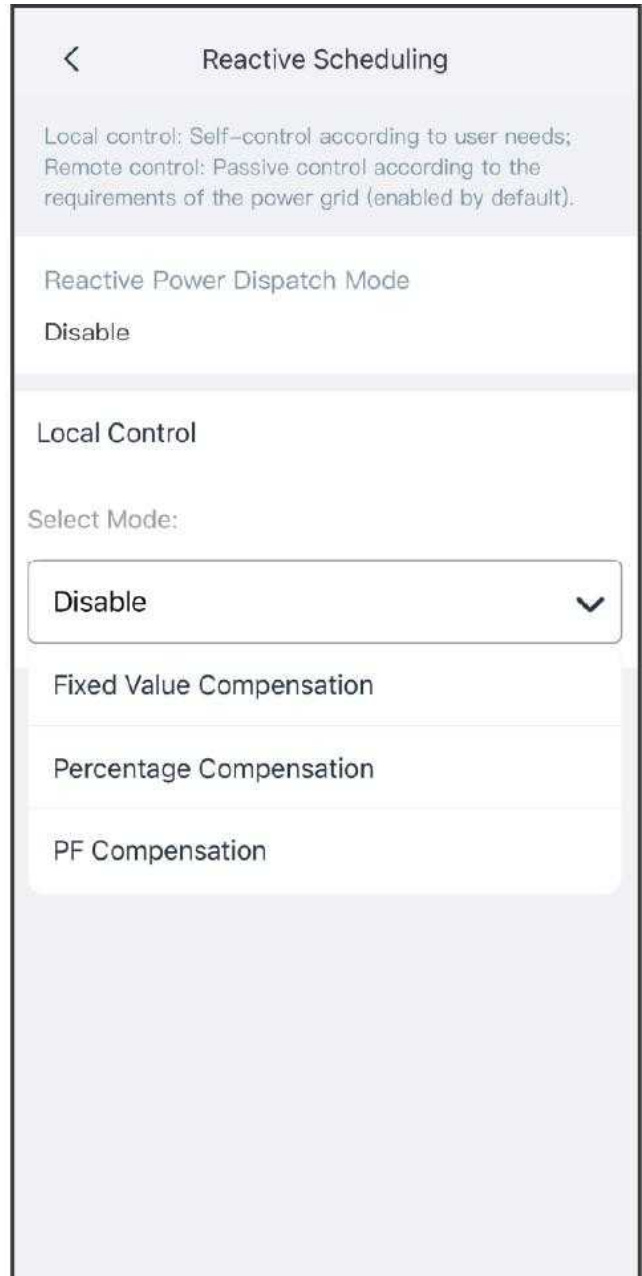
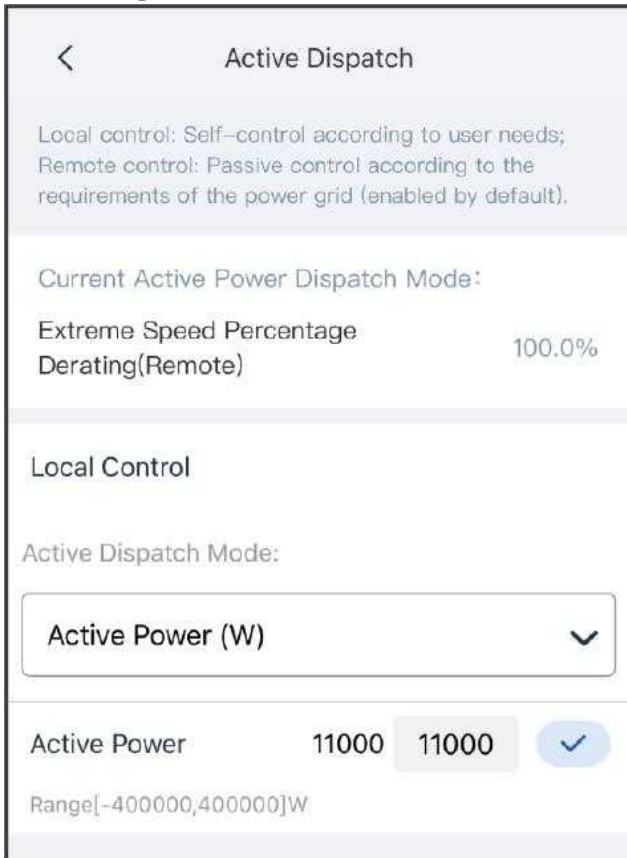

SLG00CON0124

No.	Parameter	Description
Active Scheduling		
1	Active Scheduling Mode	<p>According to the requirements of the power grid company in the country/region where the inverter is located, control the active power according to the selected dispatch mode. Supports:</p> <ul style="list-style-type: none"> • Disabled: Disables active scheduling. • Fixed value reduction: Dispatch according to a fixed value. • Percentage reduction: Dispatch based on a percentage of the rated power.
2	Active Power	<ul style="list-style-type: none"> • When the active power dispatch mode is set to fixed value derating, the active power is set to a fixed value. • When the active power dispatch mode is set to percentage derating, the active power is set as a percentage of the rated power. 比。
Reactive Scheduling		
3	Reactive Scheduling Mode	<p>According to the requirements of the power grid company in the country/region where the inverter is located, control the reactive power according to the selected dispatch mode. Supports:</p> <ul style="list-style-type: none"> • Disabled: Disables reactive scheduling. • Fixed value compensation: Dispatch according to a fixed value. • Percentage compensation: Dispatch based on a percentage of the rated power. • PF compensation.
4	Status	Set the power factor as lagging or leading based on actual needs and local grid standards and requirements.

No.	Parameter	Description
5	Reactive Power	<ul style="list-style-type: none"> When the reactive power dispatch mode is set to fixed value derating, the reactive power is set to a fixed value. When the reactive power dispatch mode is set to percentage derating, the reactive power is set as a percentage of the rated power.
6	Power Factor	When the reactive power dispatch mode is set to PF compensation, set the power factor.

8.2.9 Setting Advanced Parameters

NOTICE

Contact the supplier or after sales service for Advanced Setting password.
Password for professional technicians only.

8.2.9.1 Setting DRED/Remote Shutdown/RCR/EnWG 14a

Enable DRED/Remote Shutdown/RCR before connecting the third party DRED, remote shutdown, or RCR device to comply with local laws and regulations.

Step 1 : Tap **Home > Settings > Advanced Settings > DRED/Remote Shutdown/RCR** to set the parameters.

Step 2 : Enable or disable the function based on actual needs.

Step 3 : For areas where the EnWG 14a regulation applies, when enabling the RCR function, you need to select the RCR mode according to the actual device type and set the DI port power.

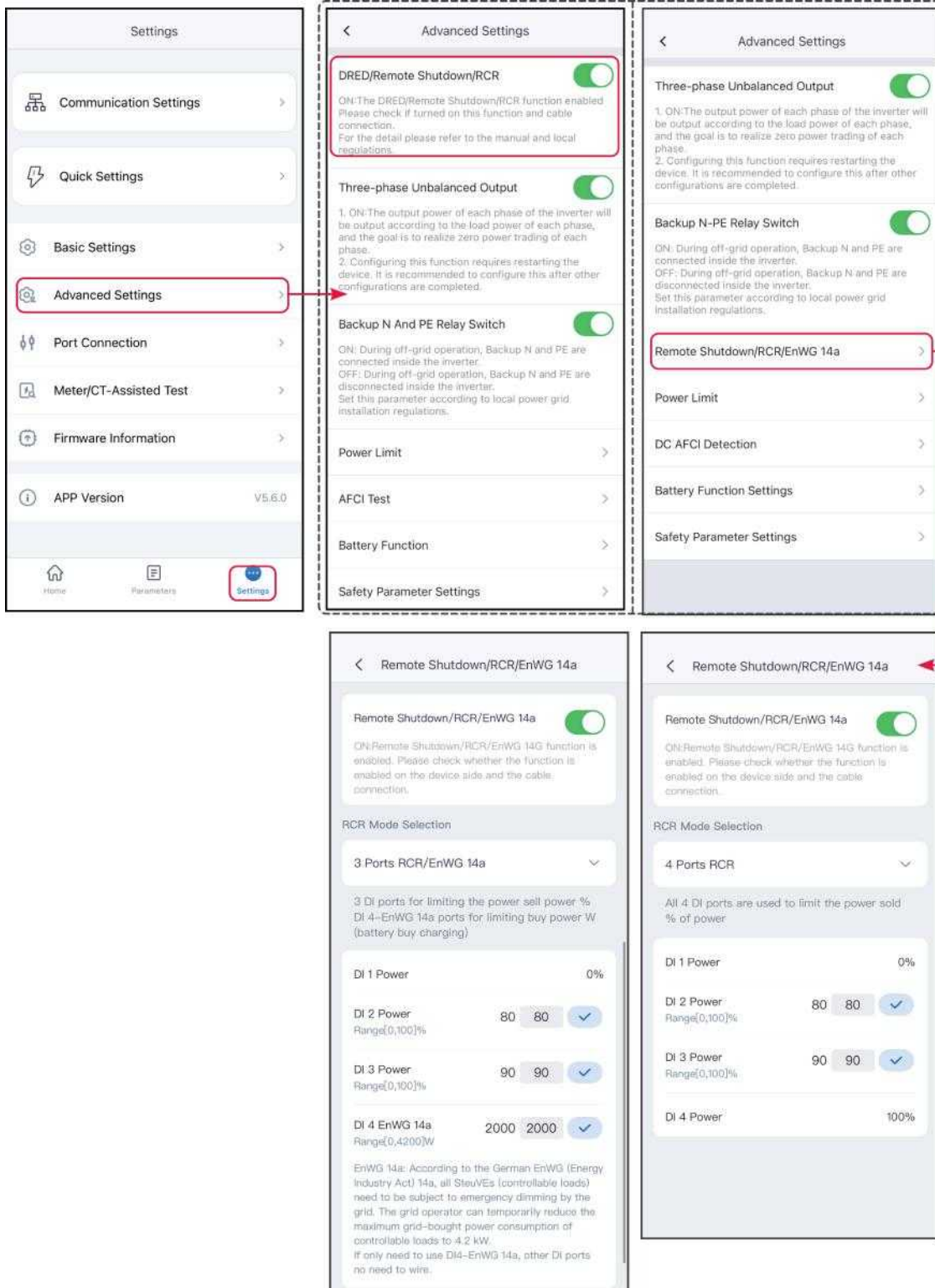

8.2.9.2 Setting the Backup N and PE Relay Switch

To comply with local laws and regulations, ensure that the relay inside the back-up

port remains closed and the N and PE wires are connected when the inverter is working off-grid.

Step 1 : Tap **Home > Settings > Advanced Settings > Backup N and PE Relay Switch** to set the parameters.

Step 2 : Enable or disable the function based on actual needs.

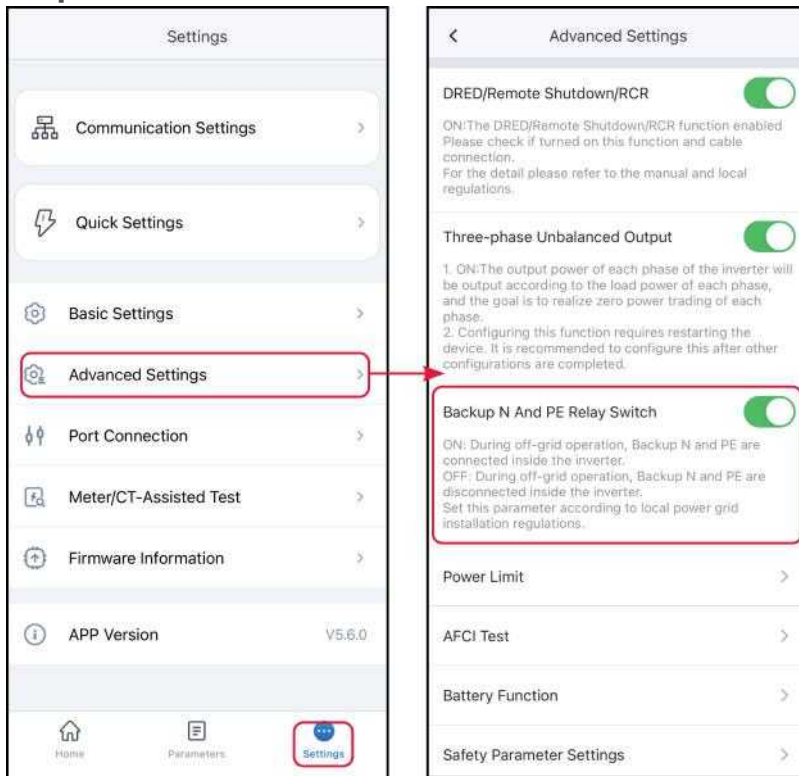

8.2.9.3 Setting the Power Limit Parameters

Step 1: Tap **Home > Settings > Advanced Settings > Power Limit** to set the parameters.

Step 2 : Turn on or off the power limit function according to actual needs.

Step 3 : After turning on the function, enter the parameter value according to actual needs and tap "v" to successfully set the parameter.

8.2.9.3.1 Set the grid-connected power limit parameters (general)

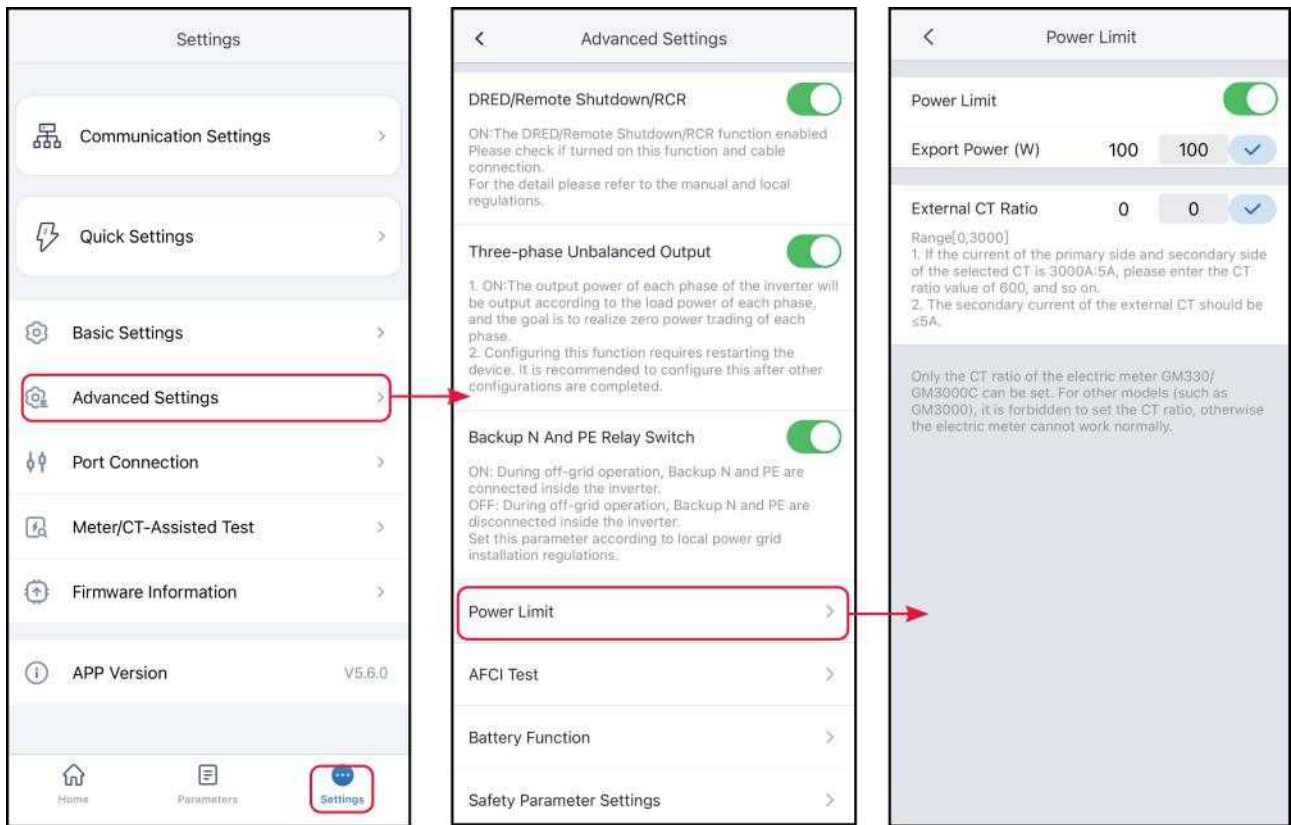

No.	Parameters	Description
1	Power Limit	Turn on this function when output power needs to be limited according to the grid standards of some countries or regions.
2	Export Power	Set according to the maximum power that can be input to the grid.
3	External Meter CT ratio	Set the ratio of the primary current to the secondary current of the external CT.

8.2.9.3.2 Setting the Power Limit Parameters (Australia)

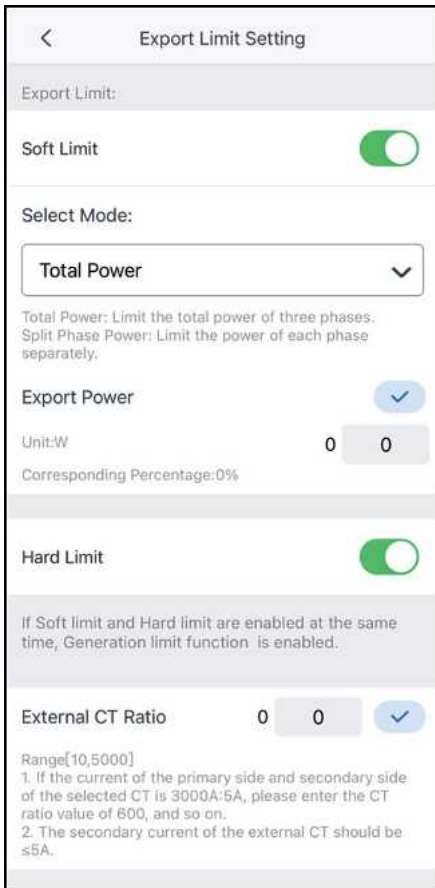

SLG00CON0133

No.	Parameters	Description
1	Software Power Limit	When output power needs to be limited according to grid standards in some countries or regions, turn on this function.
2	Limit Setting	<ul style="list-style-type: none"> • Set according to the maximum power that can be actually input to the grid. • Supports setting of fixed power value or percentage. The set percentage is the percentage of the limit power to the rated power of the inverter. • After setting the fixed value, the percentage changes automatically; after setting the percentage, the fixed value changes automatically.

No.	Parameters	Description
3	Hardware Power Limit	After enabling this function, when the amount of electricity fed into the grid exceeds the limit value, the inverter will automatically disconnect from the grid.
4	External Meter CT Ratio	Set the ratio of the primary current to the secondary current of the external CT.

8.2.9.4 Setting the AFCI Detection

Step 1 : Tap **Home > Settings > Advanced Settings > AFCI Test** to set the parameters.

Step 2 : Enable AFCI Test, Clear AFCI Alarm and Self-Check based on actual needs.

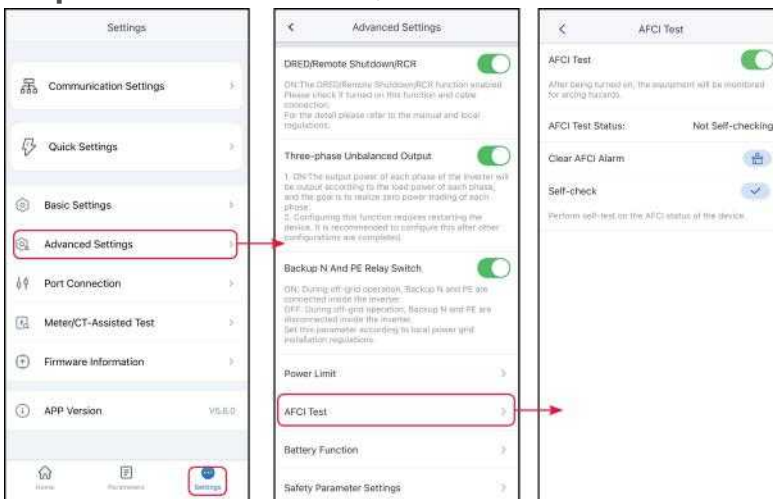

No.	Parameters	Description
1	AFCI Test	Enable or disable AFCI accordingly.
2	AFCI Test Status	The detection status like Not Self-checking.
3	Clear AFCI Alarm	Clear ARC Faulty alarm records.
4	Self-check	Tap to check whether the AFCI function works normally.

8.2.9.5 Setting the Battery

8.2.9.5.1 Set lithium Battery parameters

Step 1 Through **Home > Settings > Battery Function Settings** Enter the parameter setting interface.

Step 2 Enter parameter values as required.

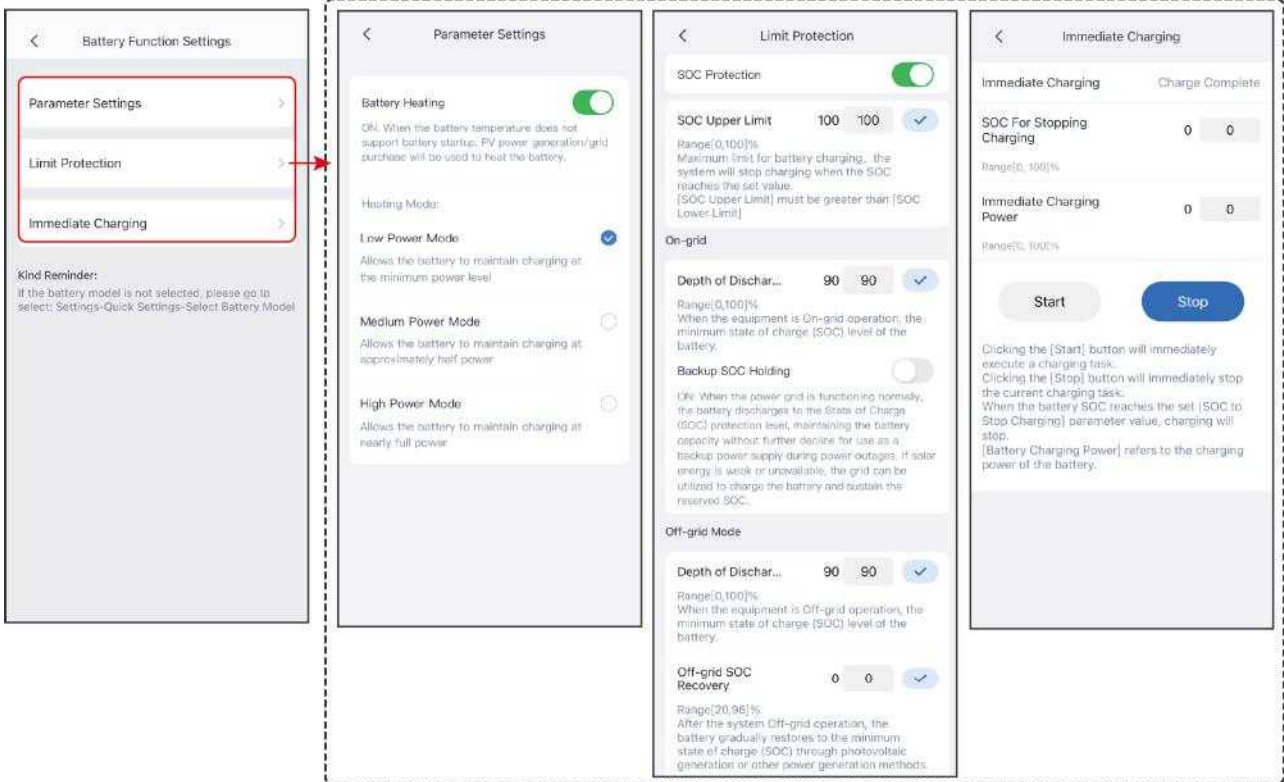

SLG00CON0072

No.	Parameter Name	Instructions
Parameter settings		
1	Maximum Charging Current	Applicable to certain models. Set the maximum Charging Current for Battery charge according to actual requirements.
2	Maximum Discharge current	Applicable to certain models. Set the maximum Discharge current for Battery discharge based on actual requirements.

No.	Parameter Name	Instructions
3	Battery heating	<ul style="list-style-type: none"> • When a Battery with heating function is selected and connected, this option will be displayed on the interface. After enabling the Battery heating function, if the Battery temperature does not support Battery startup, PV generation or grid power will be used to heat the Battery. • The model temperature varies for different Battery Heating Mode, please refer to the actual conditions. • Enabling the Battery heating function will consume a portion of the system's Power. By default, the Battery heating function operates in Low Power Mode mode, but it can be switched to other Power modes if needed. • The activation and deactivation of the Battery heating function is controlled byBMSIt is automatically controlled based on ambient temperature, so the Installation environment and location of the equipment will affect the activation and deactivation of the heating function. • If PV and AC Power only meets Load consumption, and Battery insufficient supports self-heating, then the heating function cannot be activated.
4	Battery wake-up	<p>After activation, when Battery shuts down due to undervoltage Protection, it can wake up Battery. Only applicable to lithium Battery without breaker. After activation, the output voltage of Battery port is approximately 60V.</p>
Limit Protection		
5	State of Charge (SOC)	<p>When enabled, if the Battery capacity falls below the set depth of discharge, the Protection Function can be activated for Battery.</p>
6	SOC upper limit	<p>The upper limit value of Battery charge, when the SOC of Battery reaches the upper SOC limit, Charge stops.</p>

No.	Parameter Name	Instructions
7	depth of discharge (on-grid)	Inverter During operation of on-grid, the maximum allowable value for Discharge is Battery.
8	Back-up SOC hold	To ensure that the Battery SOC is sufficient to maintain normal system operation when off-grid, during on-grid operation, Battery will purchase electricity through Utility grid to charge up to the set SOC Protection value.
9	depth of discharge(Off-grid)	Inverter During off-grid operation, Battery allows the maximum value of Discharge.
10	Off-grid Recovery SOC	During off-grid operation, if the Battery SOC drops to the lower limit, the Inverter stops output and is only used to supply power to the Battery charge until the Battery SOC recovers to the off-grid recovery SOC value. If the lower SOC limit is higher than the off-grid recovery SOC value, the Charge will adjust to the lower SOC limit +10%.
Immediate Charging		
11	Immediate Charging	After activation, Utility grid will immediately supply power to Battery charge. This effect is only triggered once. Please enable or disable this function as needed.
12	Stop the SOC of Charge	When Immediate Charging is turned on, the charging of Battery charge will stop once the SOC of Battery reaches the cutoff SOC of Charge.
13	Immediate Charging Power	When Immediate Charging is turned on, the percentage of Charge Power to Inverter Rated Power.
		For example, for a Rated Power with a capacity of 10kW, when set to 60, the Charge Power is 6kW.
14	Start	Immediately Start Charging.
15	Stop	Immediately stop the current Charge task.

8.2.9.6 Setting PV Connect Mode

Select the PV connect mode based on the actual connections between the PV strings and MPPT ports of the inverter.

Step 1 : Tap **Home > Settings > Advanced Settings > PV Connect Mode** to set the parameters.

Step 2 : Set the connect mode to Independent Access, Partial Parallel Connect or Parallel Connection based on actual connections.

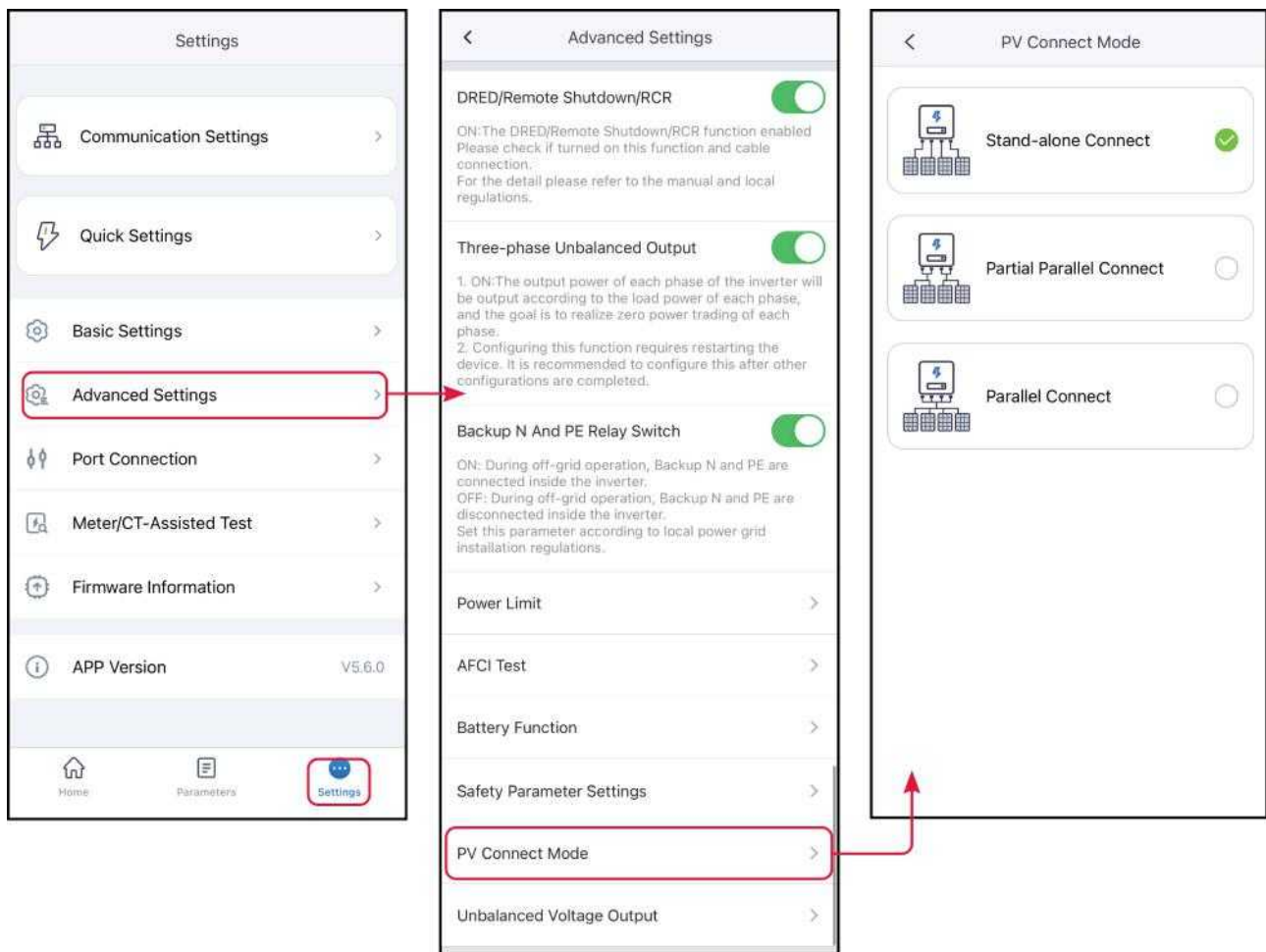

No.	Parameters	Description
1	Stand-alone Connect	The external PV string is connected to multi MPPT terminals of the inverter.

No.	Parameters	Description
2	Partial Parallel Connect	The PV strings are connected to the inverter in both stand-alone and parallel connection. For example, one PV string connect to MPPT1 ad MPPT2, another PV string connect to MPPT3.
3	Parallel Connect	When an external PV string is connected to the PV input port on the inverter side, one PV string is connected to multiple PV input ports.

8.2.10 Setting Safety Parameters

NOTICE

Set the custom safety parameters in compliance with local requirements. Do not change the parameters without the prior consent of the grid company.

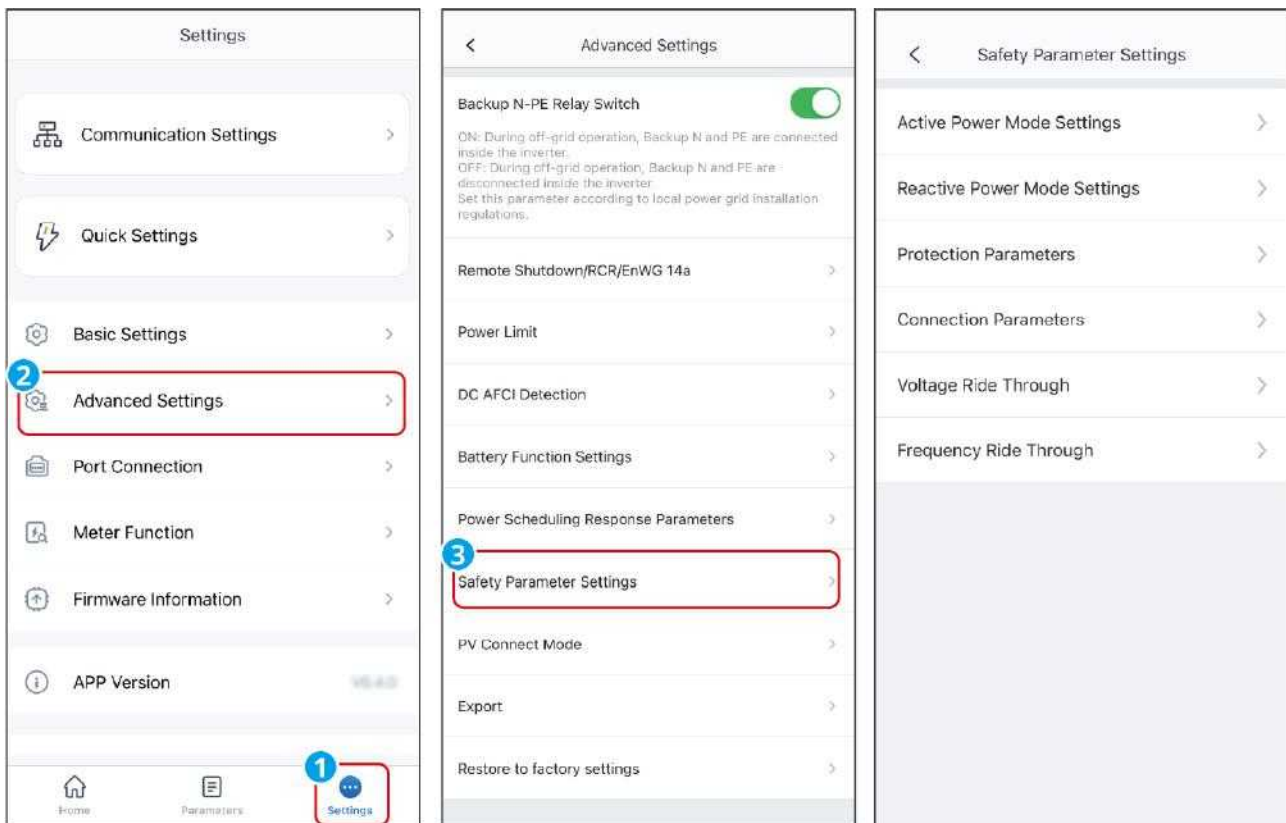

SLG00CON0076

8.2.10.1 Setting the Reactive Power Mode

Step 1 : Tap Home > Settings > Advanced Settings > Safety Parameter Setting > Reactive Power Mode Settings to set the parameters.

Step 2 : Set the parameters based on actual needs.

Q(U) Curve

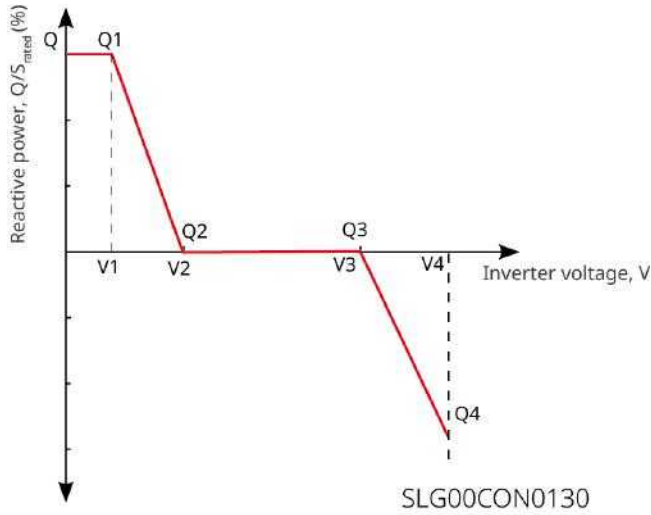

Cosφ Curve

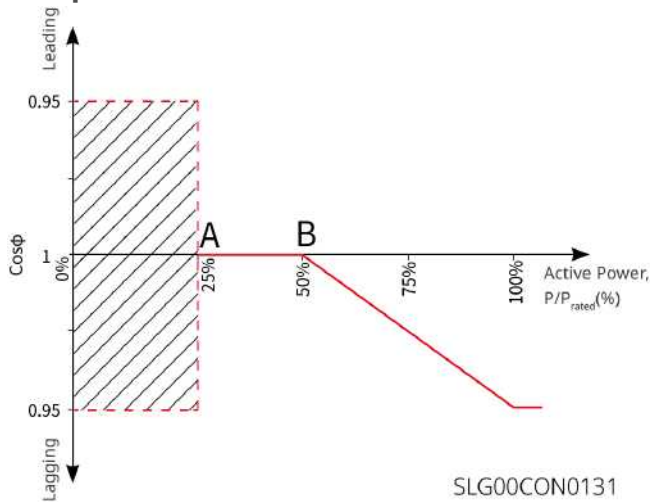

No.	Parameters	Description
Fix PF		

No.	Parameters	Description
1	Fix PF	Enable Fix PF when it is required by local grid standards and requirements. After the parameters are set successfully, the power factor remains unchanged during the operation of the inverter.
2	Under-excited	Set the power factor as lagging or leading based on actual needs and local grid standards and requirements.
3	Over-excited	
4	Power Factor	Set the power factor based on actual needs. Range: 0~-0.8, or +0.8~+1.
Fix Q		
1	Fix Q	Enable Fix Q when it is required by local grid standards and requirements.
2	Over-excited/Under-excited	Set the reactive power as inductive or capacitive reactive power based on actual needs and local grid standards and requirements.
3	Reactive Power	Set the ratio of reactive power to apparent power.
Q(U) Curve		
1	Q(U) Curve	Enable Q(U) Curve when it is required by local grid standards and requirements.
2	Mode Selection	Set Q(U) curve mode, supporting basic mode and slope mode.
3	Vn Voltage	The percentage of actual voltage to the rated voltage at Vn point, n=1, 2, 3, 4. When set to 90, it means: $V/V_{rated}\% = 90\%$.
4	Vn Reactive Power	The percentage of the reactive output power to the apparent power at Vn point, n=1, 2, 3, 4. For example, setting Vn Reactive Power to 48.5 means $Q/S_{rated}\%=48.5\%$.

No.	Parameters	Description
5	Voltage Deadband Width	When Q(U) curve mode is set to slope mode, this parameter defines the voltage deadband range where no reactive power output is required.
6	Over-excitation Slope	(In Q(U) slope mode) Sets the positive or negative slope for reactive power variation during over-voltage conditions.
7	Under-excitation Slope	
8	Vn Reactive Power	The percentage of the reactive output power to the apparent power at Vn point, n=1, 2, 3, 4. For example, setting Vn Reactive Power to 48.5 means $Q/S_{rated}\%=48.5\%$.
9	Q(U) Curve Response Time Constant	The reactive power must reach 95% of the target value within 3 time constants, following a first-order low-pass filter curve.
10	Extended Function	Enable the extended function and configure the corresponding parameters.
11	Lock-In Power	When the inverter output reactive power to the rated power ratio is between the Lock-in power and Lock-out power, the ratio meets Q(U) curve requirements.
12	Lock-out Power	
Cosφ(P) Curve		
1	Cosφ(P) Curve	Enable Cosφ Curve when it is required by local grid standards and requirements.
2	Mode Selection	Set cosφ(P) Curve Mode and support basic mode and slope mode configurations.
3	N-point Power	The percentage of inverter output active power relative to rated power at the N-point. N=A, B, C, D, E.
4	N-point cosφ Value	N-point Power Factor N=A, B, C, D, E.
5	Over-excitation Slope	

No.	Parameters	Description
6	Under-excitation Slope	When $\cos\phi(P)$ curve mode is set to slope mode, configures the power variation slope as either positive or negative.
7	N-point Power	The percentage of inverter output active power relative to rated power at the N-point. N=A, B, C.
8	N-point $\cos\phi$ Value	N-point Power Factor N=A, B, C.
9	$\cos\phi(P)$ Curve Response Time Constant	The reactive power must reach 95% of the target value within 3 time constants, following a first-order low-pass filter curve.
10	Extended Function	Enable the extended function and configure the corresponding parameters.
11	Lock-in Voltage	When the grid voltage is between Lock-in Voltage and Lock-out Voltage, the voltage meets Cos ϕ curve requirements.
12	Lock-out Voltage	
Q(P) Curve		
1	Q(P) Curve Function	Enable Q(P) Curve when it is required by local grid standards and requirements.
2	Mode Selection	Set Q(P) curve mode, supporting basic mode and slope mode.
3	Pn-point Power	The percentage of the output reactive power to the rated power at Pn point, n=1, 2, 3, 4, 5, 6. For example, setting to 90 means $Q/P_{rated}\%=90\%$.
4	Pn-point Reactive Power	The percentage of the output active power to the rated power at Pn point, n=1, 2, 3, 4, 5, 6. For example, When set to 90, it means: $P/P_{rated}\% = 90\%$.
5	Over-excitation Slope	When the Q(P) curve mode is set to slope mode, configure the power variation slope as either a positive or negative value.

No.	Parameters	Description
6	Under-excitation Slope	
7	Pn-point Power	Ratio of reactive power to rated power at Pn points (n=1, 2, 3). For example, setting to 90 means $Q/P_{rated}\%=90\%$.
8	Pn-point Reactive Power	Ratio of active power to rated power at Pn points (n=1, 2, 3). For example, When set to 90, it means: $P/P_{rated}\% = 90\%$.
9	Time Constant	The reactive power must reach 95% of the target value within 3 time constants, following a first-order low-pass filter curve.

8.2.10.2 Setting the Active Power Mode

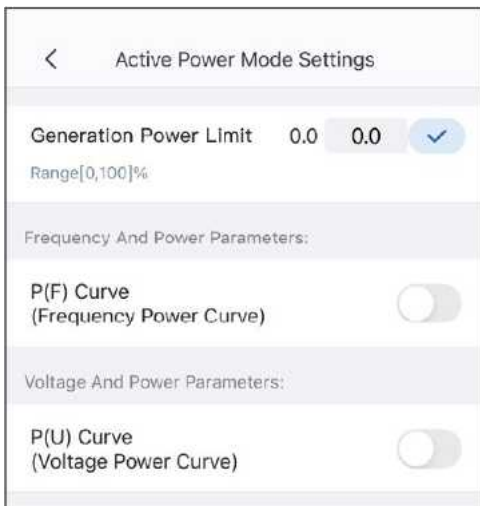

SLG00CON0149

Step 1: Tap **Home > Settings > Advanced Settings > Safety Parameter Settings > Active Power Mode Settings** to set the parameters.

Step 2: Set the parameters based on actual needs.

P(F) Curve

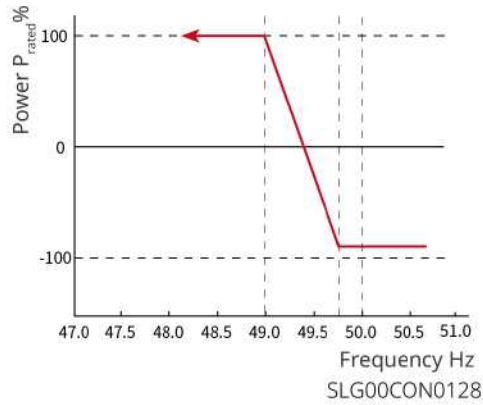
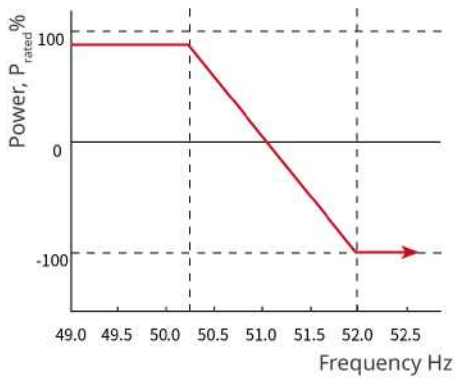

P(U) Curve

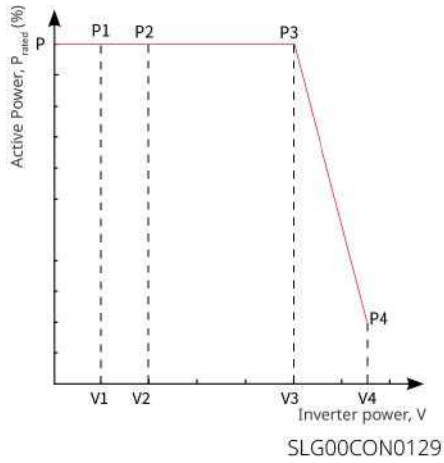

No.	Parameters	Explanation
1	Generation Power Limit	Set the change slope when the active output power increases or decreases.
2	Power Gradient	Set the active power change slope.
Overfrequency Unloading		
1	P(F) Curve	Enable P(F) Curve when it is required by local grid standards and requirements.

No.	Parameters	Explanation
2	Over-Frequency Load Shedding Mode	Set the overfrequency unloading mode based on actual needs. <ul style="list-style-type: none"> • Slope mode: adjusts power based on the over frequency point and load reduction slope. • Stop mode: adjusts the power based on the over-frequency start point and over-frequency end point.
3	Overfrequency Threshold	The inverter output active power will decrease when the utility grid frequency is too high. The inverter output power will decrease when the utility grid frequency is higher than Overfrequency Threshold .
4	Import/Export Electricity Conversion Frequency	When the set frequency value is reached, the system switches from selling electricity to buying electricity.
5	Overfrequency Endpoint	The inverter output active power will decrease when the utility grid frequency is too high. The inverter output power will stop decreasing when the utility grid frequency is higher than Overfrequency Endpoint .
6	Over-Frequency Power Slope Reference Power	Adjust the inverter output power based on Apparent Active Power, Rated Active Power, Momentary Active Power, Or Max. Active Power.
7	Power response to overfrequency gradient	The inverter output active power will increase when the utility grid frequency is too high. Indicates the slope when the inverter output power decreases.
8	Intentional Delay Ta	Indicates the delayed response time when the inverter output power is higher than the Overfrequency Threshold .

No.	Parameters	Explanation
9	Hysteretic Function	Enable the hysteretic function.
10	Frequency Hysteresis Point	During over-frequency load reduction, if the frequency decreases, the power output is based on the lowest point of the load reduction power until the frequency is less than the hysteresis point and the power is restored.
11	Hysteresis Waiting Time	For over-frequency load reduction and frequency decrease, when the frequency is less than the hysteresis point, the power recovery waiting time, that is, it takes a certain amount of time to recover the power.
12	Hysteresis Power Recovery Slope Reference Power	For over-frequency load reduction and frequency decrease, when the frequency is less than the hysteresis point, the power recovery benchmark, that is, the power recovery is based on the recovery slope * the rate of change of the reference power. Support: P _n rated power, P _s apparent power, P _m current power, P _{max} maximum power, power difference (ΔP).
13	Hysteretic Power Recovery Slope	For over-frequency load reduction and frequency reduction, when the frequency is less than the hysteresis point, the power change slope when the power is restored.
Underfrequency Loading		
1	P(F) Curve	Enable P(F) Curve when it is required by local grid standards and requirements.
2	Underfrequency Load Mode	Set the underfrequency unloading mode based on actual needs. <ul style="list-style-type: none"> • Slope mode: adjusts power based on the underfrequency point and load increase slope. • Stop mode: adjusts the power based on the underfrequency start point and underfrequency end point.

No.	Parameters	Explanation
3	Underfrequency Threshold	The inverter output active power will increase when the utility grid frequency is too low. The inverter output power will increase when the utility grid frequency is lower than Underfrequency Threshold .
4	Import/Export Electricity Conversion Frequency	When the set frequency value is reached, the system switches from selling electricity to buying electricity.
5	Underfrequency Endpoint	The inverter output active power will increase when the utility grid frequency is too low. The inverter output power will stop increasing when the utility grid frequency is lower than Underfrequency Endpoint .
6	Over-Frequency Power Slope Reference Power	Adjust the inverter output power based on Apparent Active Power, Rated Active Power, Momentary Active Power, Or Max. Active Power.
7	Under-Frequency Power Slope	The inverter output active power will increase when the utility grid frequency is too low. The slope of the inverter output power when it rises.
8	Tentional Delay Ta	Indicates the delayed response time when the inverter output power is lower than the Underfrequency Threshold .
9	Hysteretic Function	Enable the hysteretic function.
10	Frequency Hysteresis Point	During underfrequency loading, if the frequency increases, the power is output according to the lowest point of the loaded power until the frequency is higher than the hysteresis point and the power is restored.

No.	Parameters	Explanation
11	Hysteresis Waiting Time	For underfrequency loading, the frequency increases, when the frequency is higher than the hysteresis point, the waiting time for power recovery, that is, it takes a certain amount of time to recover the power.
12	Hysteresis Power Recovery Slope Reference Power	For underfrequency loading, the frequency increases, when the frequency is higher than the hysteresis point, the benchmark for power recovery, that is, the power recovery is carried out according to the recovery slope * the rate of change of the benchmark power. Support: P _n rated power, P _s apparent power, P _m current power, P _{max} maximum power, power difference (ΔP).
13	Hysteretic Power Recovery Slope	For under-frequency loading, frequency increase, when the frequency is higher than the hysteresis point, the power change slope when power is restored.
14	P(U) Curve	Enable P(U) Curve when it is required by local grid standards and requirements.
15	V _n Voltage	The percentage of actual voltage to the rated voltage at V _n point, n= 1, 2, 3, 4. For example, setting V _n Voltage to 90 means V/V _{rated} %=90%.
16	V _n Active Power	The percentage of the output active power to the apparent power at V _n point, (n= 1, 2, 3, 4). For example, setting V_n Reactive Power to 48.5 means P/P _{rated} %=48.5%.
17	Output Response Mode	Set the active power output response mode. Supports: <ul style="list-style-type: none"> • PT-1 Behavior, realize active scheduling based on the first-order LPF curve within the response time constant. • Gradient Control, realize active scheduling based on the power change slope.

No.	Parameters	Explanation
18	Power Gradient	When the output response mode is set to Gradient Control, active power scheduling is achieved according to the power change gradient.
19	First-order Low-pass Filter Time Parameter	Set the time constant within which the active power changes based on the first order LPF curve when the Output Response Mode is set to be First-order Low-pass Filter Time Parameter.
20	Overload Function Switch	When enabled, the maximum active power output is 1.1 times the rated power; otherwise, the maximum active power output is consistent with the rated power value.

8.2.10.3 Setting Protection Parameters

Step 1 : Tap **Home > Settings > Advanced Settings > Safety Parameter Settings > Protection Parameters** to set the parameters.

Step 2: Set the parameters based on actual needs.

No.	Parameters	Description
1	OV Stage n Trip Value	Set the grid overvoltage protection threshold value, n=1,2,3,4.
2	OV Stage n Trip Time	Set the grid overvoltage protection tripping time, n=1,2,3,4.
3	UV Stage n Trip Value	Set the grid undervoltage protection threshold value, n=1,2,3,4.
4	UV Stage n Trip Time	Set the grid undervoltage protection tripping time.
5	10min Overvoltage Trip Threshold	Set the 10min overvoltage protection threshold value.
6	10min Overvoltage Trip Time	Set the 10min overvoltage protection tripping time.
7	OF Stage n Trip Value	Set the grid overfrequency triggering n-th order protection point, n=1,2,3,4.

No.	Parameters	Description
8	OF Stage n Trip Time	Set the grid overfrequency trigger n-th order trip time, n=1,2,3,4.
9	UF Stage n Trip Value	Set the grid underfrequency triggering n-th order protection point, n=1,2,3,4.
10	UF Stage n Trip Time	Set the grid underfrequency trigger n-th order trip time, n=1,2,3,4.

8.2.10.4 Setting Connection Parameters

Step 1 : Tap **Home > Settings > Advanced Settings > Safety Parameter Settings > Protection Parameters** to set the parameters.

Step 2: Set the parameters based on actual needs.

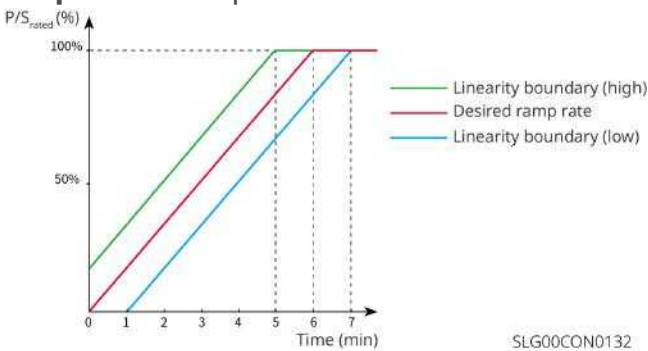

No.	Parameters	Description
Ramp Up		
1	Upper Voltage	The inverter cannot connect to the grid if it is powered on for the first connection and the grid voltage is higher than the Upper Voltage .
2	Lower Voltage	The inverter cannot connect to the grid if it is powered on for the first connection and the grid voltage is lower than the Lower Voltage .

No.	Parameters	Description
3	Upper Frequency	The inverter cannot connect to the grid if it is powered on for the first connection and the grid frequency is higher than the Upper Frequency .
4	Lower Frequency	The inverter cannot connect to the grid if it is powered on for the first connection and the grid frequency is lower than the Lower Frequency .
5	Observation Time	The waiting time for connecting the inverter to the grid when meeting the following requirements. 1. The inverter is powered on for the first connection. 2. The utility grid voltage and frequency meet certain requirements.
6	Soft Ramp Up Gradient	Enable the start up power slope.
7	Soft Ramp Up Gradient	Indicates the percentage of incremental output power per minute based on the local requirements when the inverter is powered on for the first time.
Reconnection		
8	Upper Voltage	The inverter cannot connect to the grid if it is reconnecting due to a fault and the grid voltage is higher than the Upper Voltage .
9	Lower Voltage	The inverter cannot connect to the grid if it is reconnecting due to a fault and the grid voltage is lower than the Lower Voltage .
10	Upper Frequency	The inverter cannot connect to the grid if it is reconnecting due to a fault and the grid frequency is higher than the Upper Frequency .
11	Lower Frequency	The inverter cannot connect to the grid if it is reconnecting due to a fault and the grid frequency is lower than the Lower Frequency .
12	Observation Time	The waiting time for connecting the inverter to the grid when meeting the following requirements. 1. The inverter is reconnecting to the grid due to a fault. 2. The utility grid voltage and frequency meet certain requirements.

No.	Parameters	Description
13	Reconnection Gradient	Enable the start up power slope.
14	Reconnection Gradient	Indicates the percentage of incremental output power per minute based on the local requirements when the inverter is powered on for the first time. For example, setting Reconnection Gradient to 10 means the reconnect slope is 10%P/Srated/min.

8.2.10.5 Setting Voltage Ride Through Parameters

Step 1 : Tap **Home > Settings > Advanced Settings > Safety Parameter Settings > Voltage Ride Through** to set the parameters.

Step 2 : Set the parameters based on actual needs.

No.	Parameters	Description
LVRT		
1	UVn Voltage	The ratio of the ride through voltage to the rated voltage at UVn point during LVRT. n=1,2,3,4,5,6,7。
2	UVn Time	The ride through time at UVn point during LVRT. n=1,2,3,4,5,6,7
3	Enter Into LVRT Threshold	The inverter will not be disconnected from the utility grid immediately when the grid voltage is between Enter Into LVRT Threshold and Exit LVRT Endpoint.
4	Exit LVRT Endpoint	
5	Slope K2	K-factor for reactive power during LVRT.
6	Zero Current Mode	The system outputs zero current during LVRT.

No.	Parameters	Description
7	Entry Threshold	Set the entry threshold of zero current mode.
HVRT		
1	OVn Voltage	The ratio of the ride through voltage to the rated voltage at OVn point during HVRT. n=1,2,3,4,5,6,7.
2	OVn Time	The ride through time at OVn point during HVRT. n=1,2,3,4,5,6,7.
3	Enter High Crossing Threshold	The inverter will not be disconnected from the utility grid immediately when the grid voltage is between Enter High Crossing Threshold and Exit High Crossing Threshold.
4	Exit High Crossing Threshold	
5	Slope K2	K-factor for reactive power during HVRT.
6	Zero Current Mode	The system outputs zero current during HVRT.
7	Entry Threshold	Set the entry threshold of zero current mode.

8.2.10.6 Setting Frequency Ride Through Parameters

Step 1 : Tap **Home > Settings > Advanced Settings > Safety Parameter Settings > Frequency Ride Through** to set the parameters.

Step 2 : Set the parameters based on actual needs.

No.	Parameters	Description
1	UFn Frequency	The frequency at the UFn point during frequency ride through.

No.	Parameters	Description
2	UFn Frequency	The frequency at the UFn point during frequency ride through. n=1,2,3。
3	UFn Time	The ride through duration at the UFn point during frequency ride through. n=1,2,3。
4	OFn Frequency	The frequency at the OFn point during frequency ride through. n=1,2,3。
5	OFn Time	The ride through duration at the OFn point during frequency ride through. n=1,2,3。

8.2.11 Exporting Parameters

8.2.11.1 Exporting Safety Parameters

After selecting the safety code, some models support exporting safety parameter files.

Step 1 : Tap **Home** > **Settings** > **Advanced Settings** > **Export** to export the parameters.

Step 2 : Select Safety Parameters, and tap **Export** to start downloading the current safety parameter file. When the export is complete, tap **Share** and choose how you want to open the exported file.

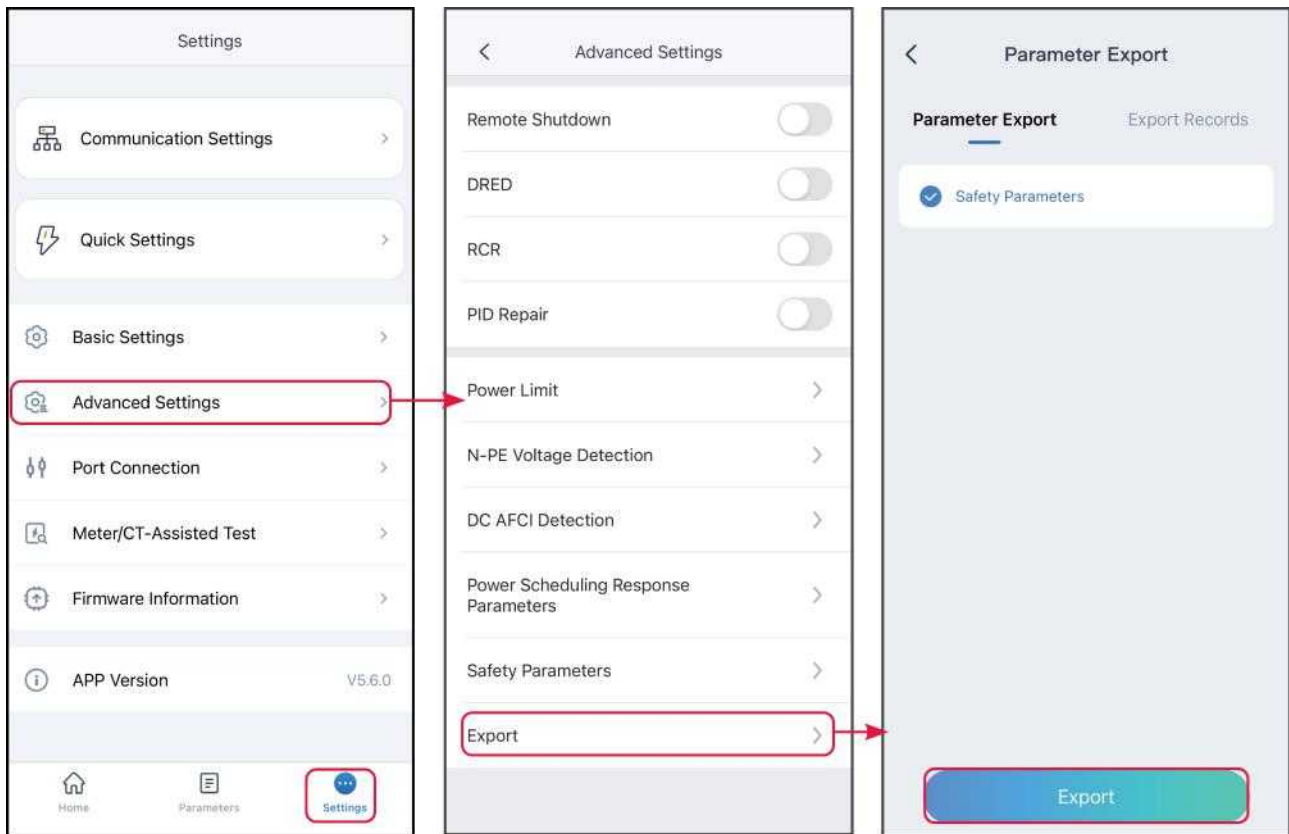

8.2.11.2 Exporting Log Parameters

Step 1 : Tap **Home > Settings > Advanced Settings > Export.**

Step 2 : Select the device type to export logs, such as inverter logs, communication module logs, etc.

Step 3: Select the log type to export, download and export the log file. After the export is complete, tap **Share** and choose how to open the exported file according to actual needs.

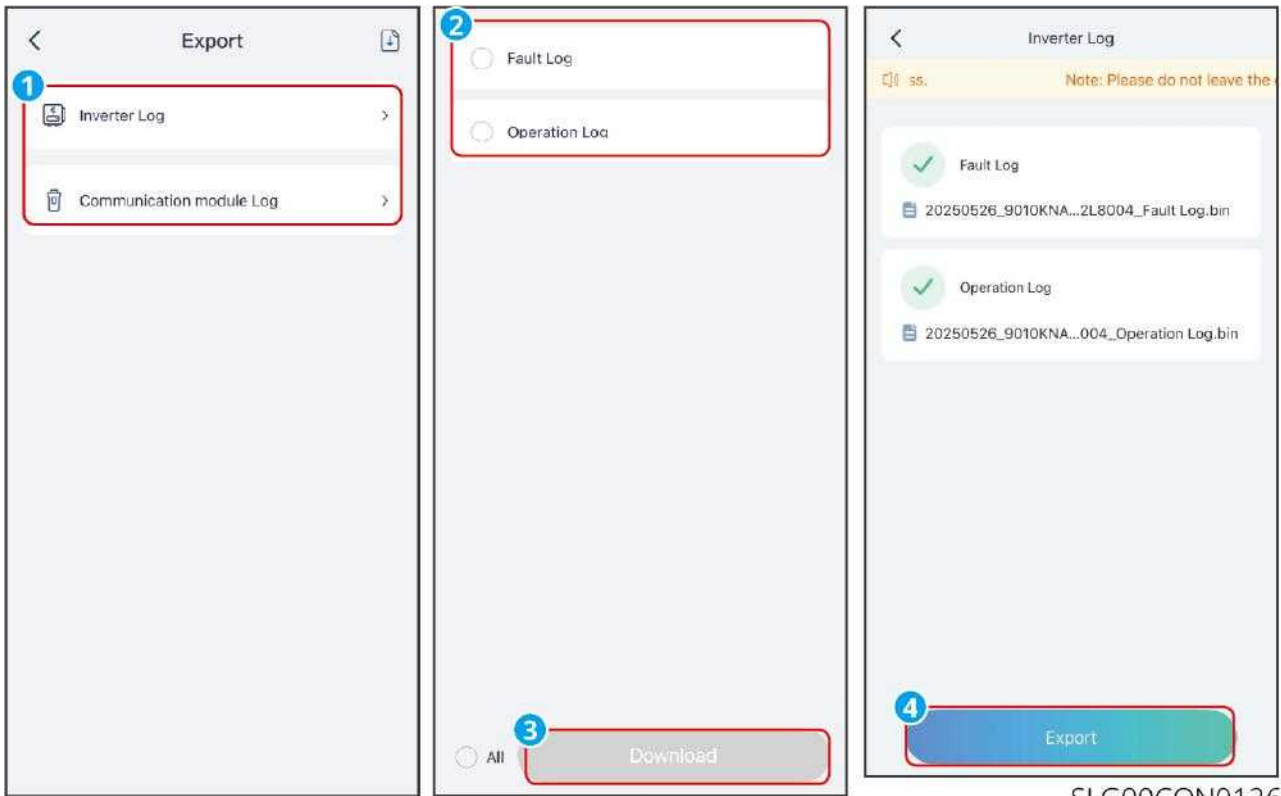

SLG00CON0126

8.2.12 Setting the Meter Parameters

8.2.12.1 Bind/Unbind Meter

NOTICE

- When the PV system uses both the grid-connected inverter and the energy storage inverter to achieve coupling or microgrid functions, dual meters may be used in the system. Please set the meter binding information according to the actual usage.
- Applicable only to GoodWe meters.

Step 1 : Tap **Home > Settings > Meter Function > Meter Binding** to enter the binding interface.

Step 2 : Tap **Quantity/Location of Meters** to select the actual application scenario. Supported options: Meter 1 (built-in) No Meter 2; Meter 1 (external) No Meter 2; Meter 1 (built-in) Meter 2 (external); Meter 1 (external) Meter 2 (external). the interface of Meter 1 (built-in) Meter 2 (external) is used as an example to explain how

to bind the meter.

Step 3 : As shown in the figure below, when you choose to use an external meter, you need to manually add the external meter information. Tap **+** to bind the meter by manually entering the meter SN or scanning the meter SN QR code. When the bound meter model is GM330, please set the meter CT ratio according to the actual situation and click **v** to complete the setting. If you use other meters, you do not need to set the meter CT ratio.

Step 4 : (Optional) If you need to unbind the external meter, please tap **Remove Binding**.

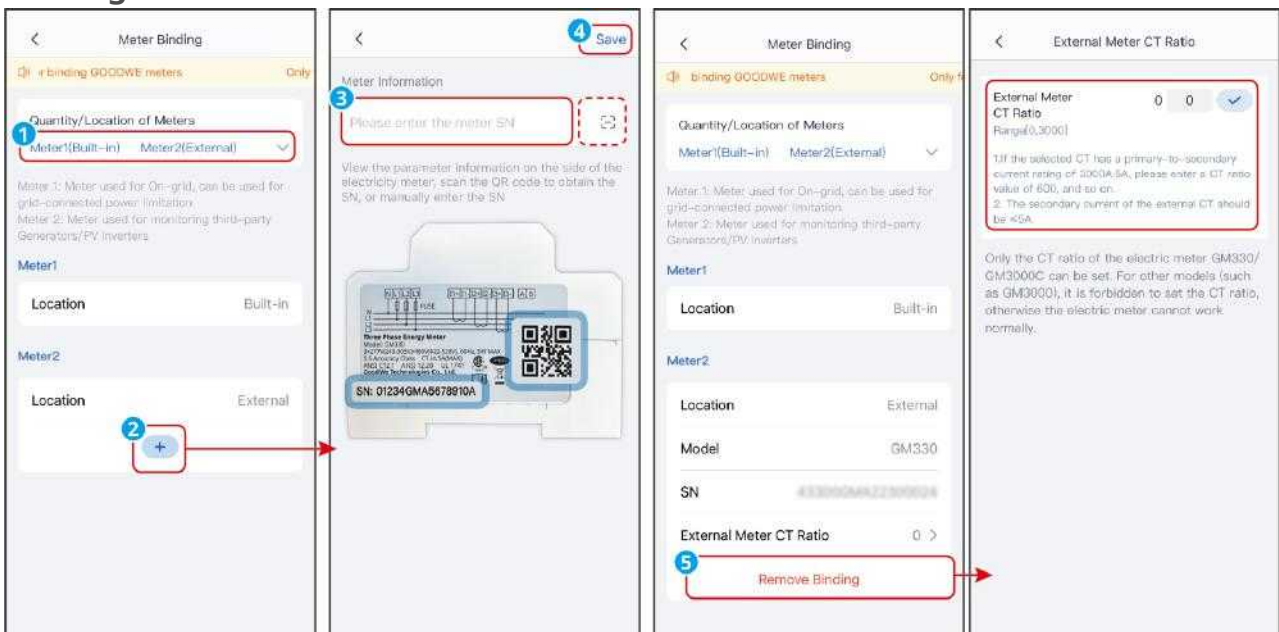

SLG00CON0123

8.2.12.2 Meter/CT-Assisted Test

Meter/CT-Assisted Test is used to auto-check if the Smart Meter and CT are connected in the right way and their working status.

Step 1 : Tap **Home > Settings > Meter/CT Assisted Test** to set the function.

Step 2 : Tap **Start Test** to start test. Check Test Result after test.

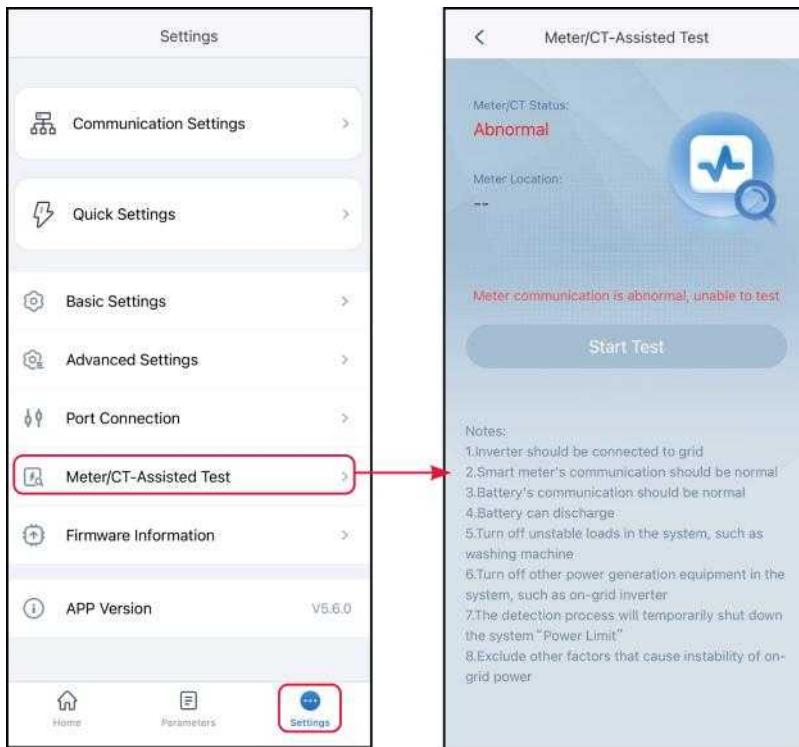

8.2.13 Setting Generator/Load Control

8.2.13.1 Setting Load Control

NOTICE

- Loads and generators can be controlled by SolarGo app when the inverter supports load control function.
- For ET40-50kW series inverters, the load control function is supported only when the inverter is used with STS. The inverter supports load control of the GENERATOR port or the BACKUP LOAD port.

Step 1: Tap **Home** > **Settings** > **Port Connection** to set the parameters.

Step 2: Select **Generator Control** or **Load Control** based on actual needs.

- **Dry Contact Mode:** when the switch is ON, the loads will be powered; when the switch is OFF, the power will be cut off. Turn on or off the switch based on actual needs.

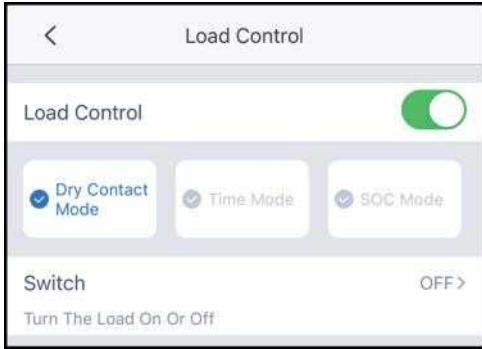

- Time Mode: set the time to enable the load, and the load will be powered automatically within the setting time period. Select standard mode or intelligent mode.

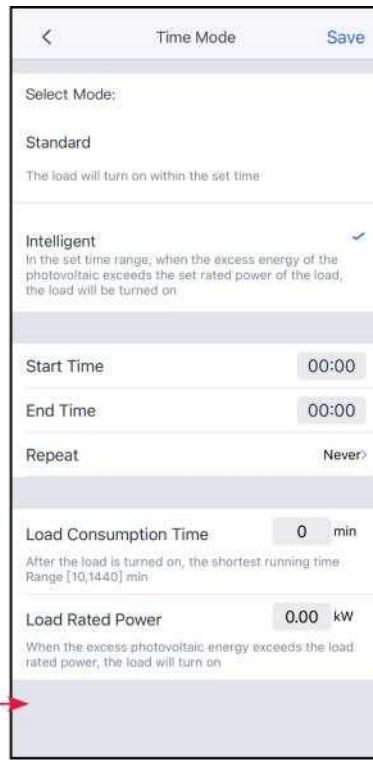

No.	Parameters	Description
1	Standard	The loads will be powered within the setting time period.
2	Intelligent	Once the excess energy of the photovoltaic exceeds the load nominal power within the time period, the loads will be powered.
3	Start Time	The time mode will be on between the Start Time and End Time.
4	End Time	

No.	Parameters	Description
5	Repeat	The repeat days.
6	Load Consumption Time	The shortest load working time after the loads been powered. The time is set to prevent the loads be turned on and off frequently when the PV power fluctuates greatly. Only for Intelligent mode.
7	Load Rated Power	The loads will be powered when the excess energy of the photovoltaic exceeds the nominal power of load. Only for Intelligent mode.

- SOC Mode: the inverter has integrated dry contact controlling port, which can control whether the load is powered or not by contactor. In off-grid mode, the load connected to the port will not be powered if the BACKUP overload is detected or the battery SOC value is lower than the Off-grid battery protection value. Set Off-grid Battery Protection Value based on actual needs.



8.2.13.2 Setting the Generator Parameters

NOTICE

- When the inverter supports the generator control function, the generator can be controlled through the SolarGo App.
- For ET40-50kW series inverters, the generator can be connected and controlled only when the inverter is used with STS.

Step 1 : Tap **Home > Settings > Port Connection** to set the parameters.

Step 2: Select Generator Connection or Load Connection based on actual needs.

Step 3 : When setting the generator control function, select the generator type according to the actual access situation. Currently supported:**Not Installed, Manual Control Of Generator** or **Automatic Control Generator**. And set the parameters according to the selected generator type.

- Not Installed: If no generator is connected in the system, select Not Installed.
- Manual Control Of Generator(Doesn't Support Dry Node Connection): Start or stop the generator manually. The inverter cannot control the generator when Manual Control Of Generator(Doesn't Support Dry Node Connection) is selected.
- Automatic control generator (Supports dry node connection): If the generator has dry contact port and is connected to the inverter, set the generator control mode to Switch Control Mode or Automatic Control Mode based on actual needs.
 - Switch Control Mode: The generator will start working when the Generator Dry Node Switch is on, and stop automatically after reaching Run Time.
 - Automatic Control Mode: The generator will work during Run Time, but stop working during Prohibited Working Hours.

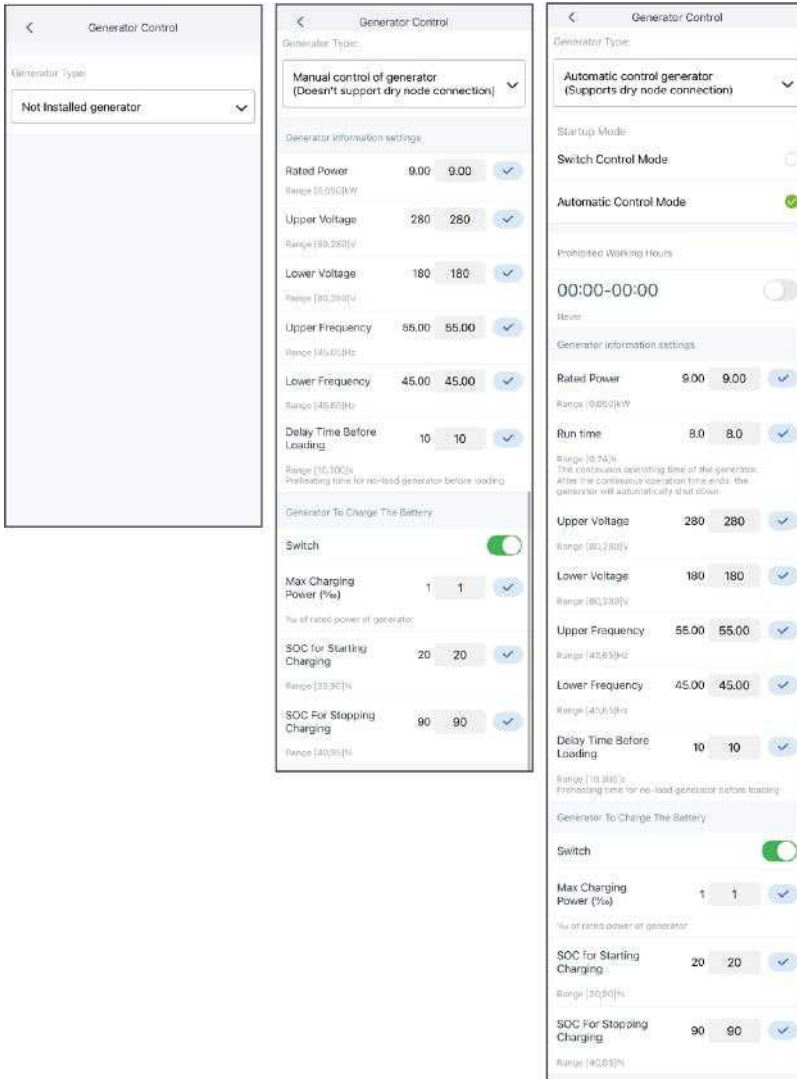

SLG00CON0079

No.	Parameters	Description
1	Startup Mode	Switch Control Mode/Automatic Control Mode
Switch Control Mode		
2	Generator Dry Node Switch	Only for Switch Control Mode.
3	Run Time	Set the generator's continuous runtime, after which the generator will be turned off.
Automatic Control Mode		
4	Prohibited Working Hours	Set the time period during which the generator cannot work.

No.	Parameters	Description
5	Run Time	Set the generator's continuous runtime, after which the generator will be turned off. If the generator start-up operation time includes prohibited working time, the generator will stop running during this time period; after the prohibited working time, the generator will restart running and timing.

No.	Parameters	Description
Generator Information Settings		
1	Rated Power	Set the rated power of the generator.
2	Run Time	Set the continuous running time of the generator. The generator will be shut down after the continuous running time ends.
3	Upper Voltage	Set the operation voltage range of the generator.
4	Lower Voltage	
5	Frequency Cap	Set the operation frequency range of the generator.
6	Lower Frequency	
7	Preheating time	Set the generator no-load preheating time.
Parameter settings for generator charging batteries		
8	Switch	Select whether to use the generator to generate electricity to charge the battery.
9	Max.charging power (%)	The charging power when the generator generates electricity to charge the battery.
10	Start charging SOC	When the battery SOC is lower than this value, the generator generates electricity to charge the battery.
11	Stop charging SOC	When the battery SOC is higher than this value, stop charging the battery.

8.2.13.3 Setting Microgrid Parameters

NOTICE

When the inverter supports microgrid function, you can set microgrid parameters through SolarGo App.

Step 1 : Tap **Home > Settings > Port Connection** to set the parameters.

Step 2 : According to the actual interface prompts, enter the microgrid control interface and set the microgrid parameters according to actual needs.



SLG00CON0078

No.	Parameters	Description
1	Maximum SOC for Charging	Set the upper limit of charging SOC, and stop charging when the upper limit is reached.

No.	Parameters	Description
2	Manual wake-up	<ul style="list-style-type: none"> When the grid fails, if the battery power is low, the energy storage inverter cannot be supported to work off the grid. Click this button to force the energy storage inverter to output voltage to the grid-connected inverter, thereby starting the grid-connected inverter. Single effect.
3	Automatic wake-up	<ul style="list-style-type: none"> When the grid fails, if the battery power is low, the energy storage inverter cannot be supported to work off the grid. After enabling this function, the system will force the energy storage inverter to output voltage to the grid-connected inverter at a fixed time, thereby starting the grid-connected inverter. Multiple effect.
4	Grid Import Power Limit Offset	Set the adjustable range of the maximum power that the device can actually buy from the grid.

8.2.14 Equipment Maintenance

8.2.14.1 Checking Firmware Information/Upgrading Firmware Version

Upgrade the DSP version, ARM version, BMS version, AFCI version, or STS version of the inverter, or firmware version of the communication module. Some devices do not support upgrading the firmware version through SolarGo app.

NOTICE

If the Firmware Upgrade dialog box pops up once logging into the app, click Firmware Upgrade to directly go to the firmware information page.

8.2.14.1.1 Regular Upgrade

NOTICE

- When there is a red dot on the right side of the firmware information, please click to view the firmware update information.
- During the upgrade process, please ensure that the network is stable and the device is connected to SolarGo, otherwise the upgrade may fail.

Step 1 : Tap **Home > Settings > Firmware Information** to check the firmware version. If the firmware upgrade dialog box pops up, tap **Firmware Upgrade** and turn to the upgrade interface.

Step 2 : (Optional) Tap **Check For Update** to confirm whether the latest firmware version is available for updating.

Step 3: Tap **Firmware Upgrade** to enter the firmware upgrade interface.

Step 4 : (Optional) Tap **Learn More** to view firmware-related information, such as the current version, the latest version, firmware update records, etc.

Step 5 : Tap **Upgrade** and complete the upgrade according to the prompts on the interface.

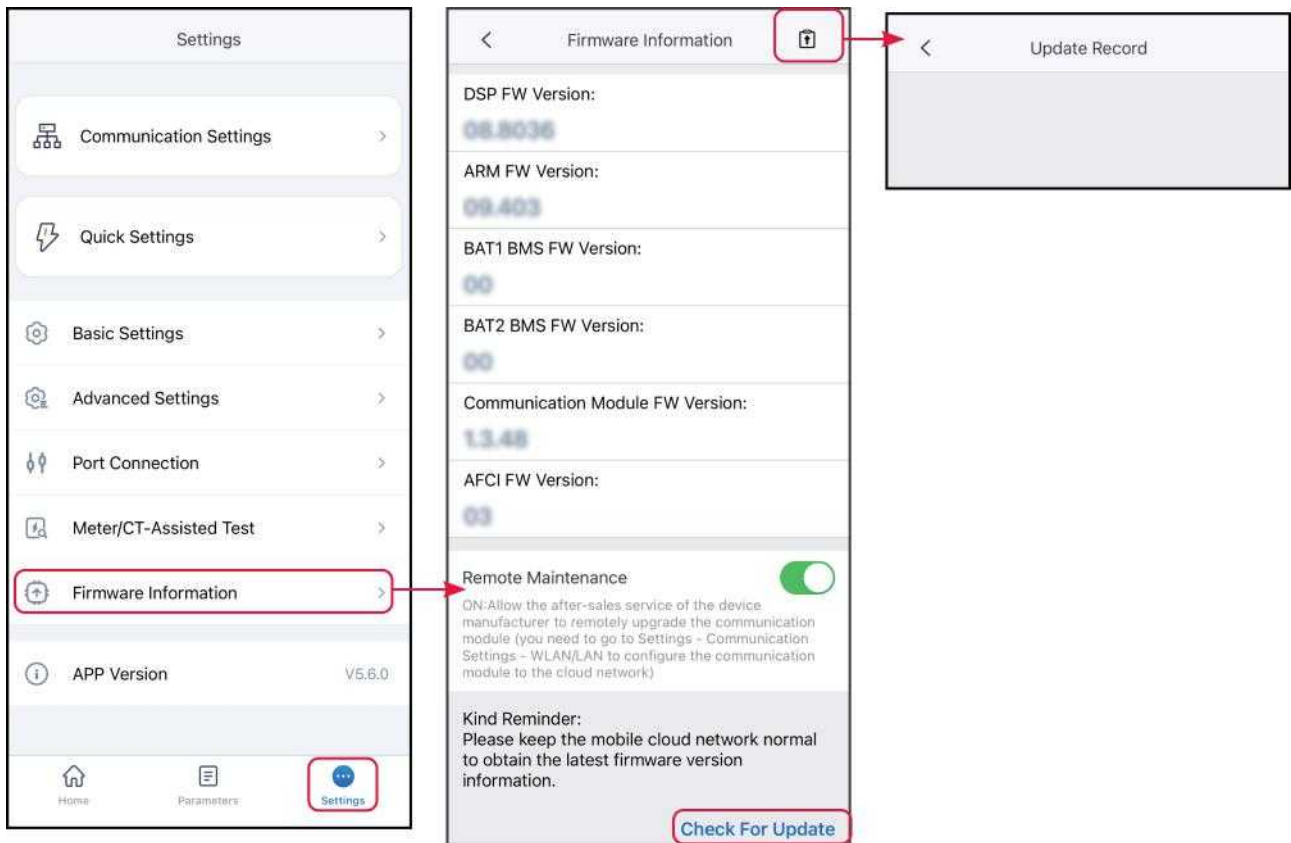

8.2.14.1.2 One-click Upgrade

NOTICE

- When there is a red dot on the right side of the firmware information, please click to view the firmware update information.
- During the upgrade process, please ensure that the network is stable and the device is connected to SolarGo, otherwise the upgrade may fail.

Step 1 : Tap **Home** > **Settings** > **Firmware Information**. Tap **Firmware Information** as prompted to enter the firmware upgrade page.

Step 2 : Tap **Upgrade** and follow the prompts to complete the upgrading. If you only need to upgrade a specific firmware version, tap **Learn More** to check the firmware related information and tap **Firmware Upgrade** below the firmware version you want to upgrade, and follow the on-screen prompts to complete the operation.

Step 3 : Tap **Learn More** to view all current firmware version information.

Step 4: (Optional) Tap ,to view the version upgrade record.

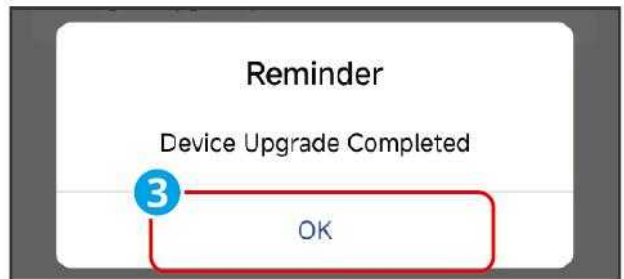
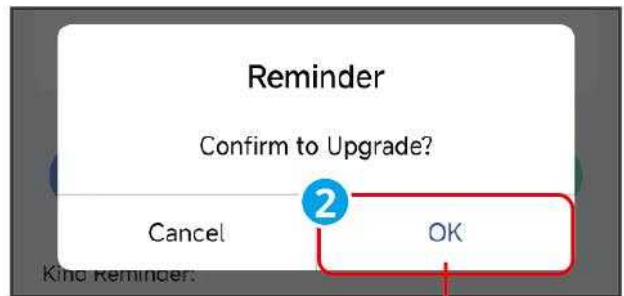
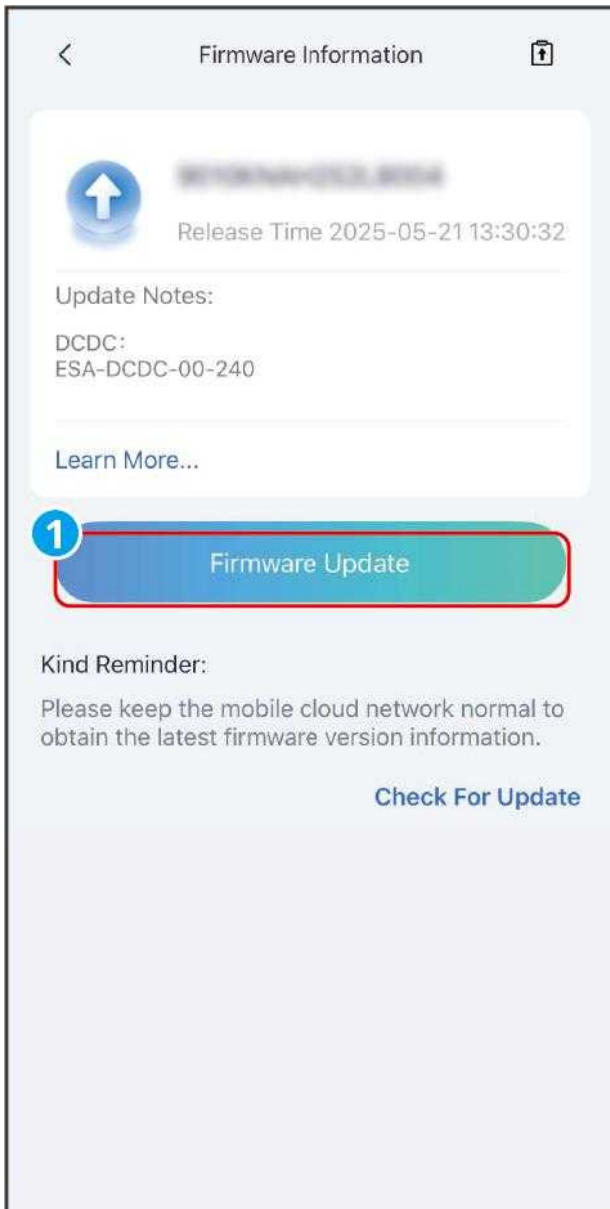

SLG00CON0127

8.2.14.1.3 Automatic Upgrade

NOTICE

- When using WiFi/LAN Kit-20 or WiFi Kit-20 module communication and the module firmware version is V2.0.1 or above, the device automatic upgrade function can be enabled.
- After the device automatic upgrade function is enabled, if the module version is updated and the device has been connected to the network, the corresponding firmware version can be automatically upgraded.

Step 1 : Tap **Home > Settings > Firmware Information.**

Step 2 : Enable or disable the automatic device upgrade function according to actual needs.

8.2.14.1.4 Checking Firmware Information

Step 1: Tap **Parameters > Firmware Version** to check the version information.



SLG00CON0191

8.2.14.2 Change the Login Password

NOTICE

The login password can be changed. Keep the changed password in mind after changing it. Contact the after-sales service if you forget the password.

Step 1 : Tap **Home > Settings > Change Login Password** to change the password.

Step 2 : Change the password based on actual needs.

< Change Login Password Save

Please enter the new password 

Please enter new password again 

Note: 8-16 characters, need a combination of numbers and uppercase or lowercase letters (0-9, a-z, A-Z)

SLG00CON0088

9 Monitoring via SEMS+ AU/NZ

For the Australian region:

SEMS+ AU/NZ App is a software application designed for remote power plant monitoring or local equipment debugging and configuration. It enables installers or owners to:

- Monitor the operational status of power plants remotely and configure the operating parameters for both the plants and their equipment.
- Connect to devices locally to check their operational status and adjust device parameters.

For detailed functions, please refer to the SEMS+ AU/NZ App User Manual:

https://admin.goodwe.com/Ftp/EN/Downloads/User%20Manual/GW_SEMS-PLUS-APP_User-Manual-EN.pdf



SEMS+ AU/NZ App User Manual

9.1 Download and Install SEMS+ AU/NZ App

Phone Requirements:

- Operating System: Android 7.0 or later, iOS 15.1 or later.
- Phone must support a web browser and have an Internet connection.
- Phone must support WLAN/Bluetooth functionality.

Download Methods:

Method 1:

Search for "SEMS+ AU/NZ" in Google Play, App Store, Huawei, Honor, Xiaomi, OPPO, or vivo app stores to download and install.



Method 2:

Scan the QR code below to download and install.



10 Monitoring via SEMS+

Other Regions:

SEMS+ App is software used for power plant monitoring. The following are the common features of SEMS+:

1. Manage organization or user information, etc.
2. Add and monitor power plant information, etc.
3. Maintain equipment.

For detailed functions, please refer to the SEMS+ App User Manual.

https://en.goodwe.com/Ftp/EN/Downloads/User%20Manual/GW_SEMS-PLUS_User-Manual-EN.pdf



SEMS+ App User Manual

11 Maintenance

11.1 Power OFF the System

DANGER

- When performing operation and maintenance on equipment in the system, please ensure the Power OFF the System is properly handled. Operating live equipment may cause equipment damage or electric shock DANGER.
- After the equipment is POWER OFF, the internal components Discharge require a certain amount of time. Please wait until the equipment is fully Discharge according to the time indicated on the label.
- Restart Battery should be performed using the circuit breaker power on method.
- When closing Battery system, strictly adhere to the Battery system power off requirements to prevent damage to Battery system.

NOTICE

To ensure effective protection of the Battery system, the cover plate of the Battery system switch must remain closed. If the Battery system switch is not in use for an extended period, it should be secured with screw.

power off

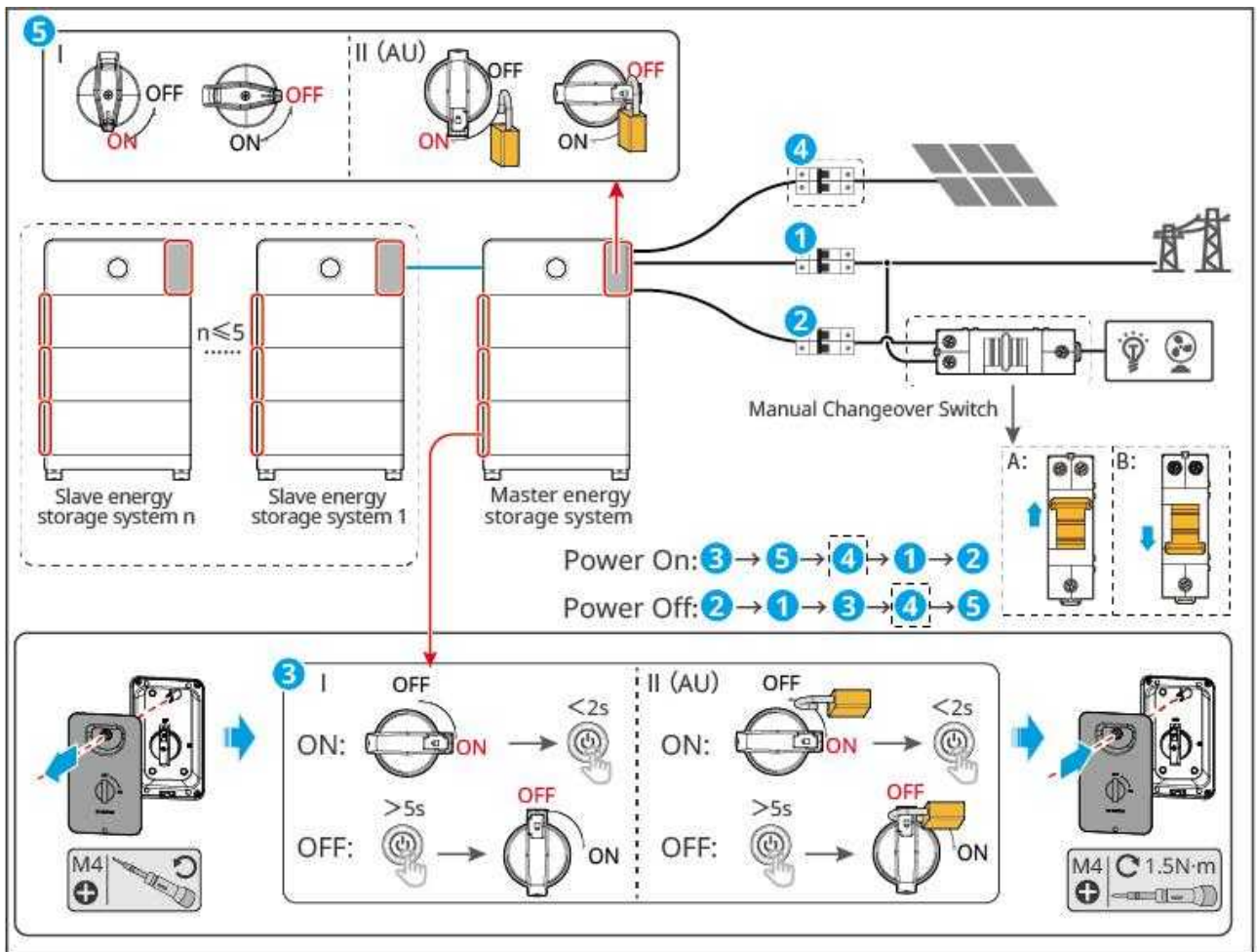

ESA20PWR0002

1. Disconnect the BACK-UP breaker.
2. Disconnect the ON-GRID breaker.
3. Press and hold any Battery multifunction button for 5 seconds to power off the Battery system. If the system contains multiple Battery, this operation will power off all Battery without the need for individual unit operation. Finally, rotate the Battery system switch to the OFF position.
4. (Optional) Disconnect the breaker between the PV module and the Inverter.
5. Disconnect the DC Switch of Inverter. (Optional) Set the manual transfer switch to position A.

11.2 Removing the Equipment

 DANGER

- Make sure that the equipment is powered off.
- Wear proper PPE during operations.
- Please use standard disassembly tools when removing wiring terminals to avoid damaging the terminals or equipment.
- Unless otherwise specified, the dismantling process of the equipment is in reverse order to the installation process, and it will not be further elaborated in this document.

1. Power off the System.
2. Label the cables connected in the system with tags indicating the cable type.
3. Disconnect the connecting cables of the inverter, battery, and smart meter in the system, such as DC cables, AC cables, communication cables, and PE cables.
4. Remove equipment such as the smart dongle, inverter, battery, and smart meter.
5. Properly store the equipment and ensure that the storage conditions meet the requirements if it needs to be put into use later.

11.3 Disposing of the Equipment

If the equipment cannot work anymore, dispose of it according to the local disposal requirements for electrical equipment waste. The equipment cannot be disposed of together with household waste.

11.4 Routine Maintenance

WARNING

- Contact after-sales service for help if you find any problems that may influence the battery or the hybrid inverter. Disassemble without permission is strictly forbidden.
- Contact after-sales service for help if the copper conductor is exposed. Do not touch or disassemble privately because high voltage danger exists.
- In case of other emergencies, contact the after-sales service as soon as possible. Operate following the instructions or wait for the after-sales service personnel.

Maintaining Item	Maintaining Method	Maintaining Period	Maintaining Purpose
System Cleaning	Check the heat sink, air intake, and air outlet for foreign matter or dust. Check whether the installation space meets requirements and whether there is any debris around the device.	Once 6 months	Prevent heat dissipation failures.
System installation	Check whether the equipment are installed securely and whether the screws are installed tightly. Check whether the equipment is damaged or deformed.	Once 6-12 months	Ensure that the equipment is installed securely.
Electrical connection	Check whether the cables are securely connected. Check whether the cables are broken or whether there is any exposed copper core.	Once 6-12 months	Confirm the reliability of electrical connections.
Sealing	Check whether all the terminals and ports are properly sealed. Reseal the cable hole if it is not sealed or too big.	Once a year	Confirm that the machine seal and waterproof performance are intact.
Battery maintenance	If the battery is not used for a long time or is not fully charged, it is recommended to charge the battery regularly.	Once/15 days	Protect the battery's lifespan.

11.5 Fault

11.5.1 Viewing Fault/Alarms Information

All fault and alarm details for the energy storage system are displayed in the **[SolarGo App]** and **[SEMS+ APP]**. If your product malfunctions and you do not see the relevant fault information in the **[SolarGo App]** and **[SEMS+ APP]**, please contact the after-sales service center.

- **SolarGo App**

Through **[Home]** > **[Parameters]** > **[Alarms]**, View the alarm information of the energy storage system.

- **SEMS+ APP**

1. Open the SEMS+ App and log in with any account.
2. All power station fault information can be viewed through the **Power Plant > Alarm**.
3. Click on the specific fault name to view detailed information about the fault: [time of occurrence], [possible cause], and [solution].

11.5.2 Fault Information and Troubleshooting

Perform troubleshooting according to the following methods. Contact the after-sales service if these methods do not work.

Collect the information below before contacting the after-sales service, so that the problems can be solved quickly.

1. Product information like serial number, software version, installation date, fault time, fault frequency, etc.
2. Installation environment, including weather conditions, whether the PV modules are sheltered or shadowed, etc. It is recommended to provide some photos and videos to assist in analyzing the problem.
3. Utility grid situation.

If unlisted problems occur in the system, or if following the instructions does not stop the problem or abnormality, stop operating the system immediately and contact your dealer immediately.

No.	Fault	Solutions/measures to address the issue
1	Unable to search for the wireless signal of the smart dongle.	<ol style="list-style-type: none"> 1. Please ensure that no other devices are connected to the smart dongle's wireless signal. 2. Please ensure that the SolarGo app has been updated to the latest version. 3. Please ensure that the smart dongle is powered on properly, and the blue indicator light is blinking or steady on. 4. Ensure that the smart device is within the communication range of the smart dongle. 5. Refresh the device list in the app. 6. Restart the inverter.
2	Unable to connect to the wireless signal of the smart dongle.	<ol style="list-style-type: none"> 1. Please ensure that no other devices are connected to the smart dongle's wireless signal. 2. Restart the inverter or smart dongle, and try to reconnect to the wireless signal of the smart dongle again. 3. Ensure successful pairing of Bluetooth.
3	Cannot find router SSID.	<ol style="list-style-type: none"> 1. Put the router nearer to the Smart Dongle. Or add a WiFi relay device to enhance the WiFi signal. 2. Reduce the number of devices connected to router.
4	After completing all configurations, the Smart Dongle fails connecting to the router.	<ol style="list-style-type: none"> 1. Restart the inverter. 2. Check if the SSID, encryption method and password on WiFi configuration page are the same with that of Router. 3. Restart the router. 4. Put the router nearer to the Smart Dongle. Or add a WiFi relay device to enhance the WiFi signal.

No.	Fault	Solutions/measures to address the issue
5	After completing all configurations, the Smart Dongle fails connecting to the router.	Restart the router and the inverter.

11.5.2.1 Inverter fault

fault code	fault name	fault cause	Troubleshooting recommendation
F01	Grid Power Outage	<ol style="list-style-type: none"> Utility grid power outage. AC line or AC Switch disconnected. 	<ol style="list-style-type: none"> The alarm automatically disappears after Grid connected recovery. Check if the AC line or AC Switch is disconnected.
F02	Grid Overvoltage Protection	Utility gridvoltage exceeds the allowable range, or the high voltage Duration surpasses the high voltage ride-through setting value.	<ol style="list-style-type: none"> If it occurs occasionally, it may be due to a temporary abnormality in the Utility grid. The Inverter will resume normal operation after detecting that the Utility grid is functioning properly, without requiring manual intervention. If it occurs frequently, check whether Utility grid and voltage are within the allowable range. <ul style="list-style-type: none"> If Utility gridvoltage

fault code	fault name	fault cause	Troubleshooting recommendation
			<p>exceeds the permissible range, please contact the local power operator.</p> <ul style="list-style-type: none"> • If the Utility gridvoltage is within the allowable range, it is necessary to modify the InverterGrid Overvoltage Protection point after obtaining consent from the local power operator, HVRTEnable or disable the Grid Overvoltage Protection function. <p>3. If the issue persists for an extended period, please check whether the breaker on the AC side and the output cables are properly connected.</p>
F03	Grid Undervoltage Protection	Utility gridvoltage is below the allowable range, or the low-voltage Duration exceeds the Low Voltage ride-through setting value.	<p>1. If it occurs occasionally, it may be due to a temporary anomaly in Utility grid. The Inverter will resume normal operation after detecting that Utility grid is functioning properly, without requiring manual intervention.</p> <p>2. If it occurs frequently,</p>

fault code	fault name	fault cause	Troubleshooting recommendation
			<p>check whether the Utility grid and voltage are within the allowable range.</p> <ul style="list-style-type: none"> • If Utility gridvoltage exceeds the permissible range, please contact the local power operator. • If the Utility gridvoltage is within the allowable range, it is necessary to modify the InverterGrid Undervoltage Protection point after obtaining consent from the local power operator.LVRTEnable or disable the Grid Undervoltage Protection function. <p>3. If the issue persists for an extended period, please check whether the AC-side breaker and output cables are properly connected.</p>
F04	Grid Rapid Overvoltage Protection	Utility gridvoltage detection shows abnormality or ultra-high voltage triggers fault.	1. If it occurs occasionally, it may be due to a temporary anomaly in Utility grid. Inverter will resume normal operation after detecting that Utility grid is functioning

fault code	fault name	fault cause	Troubleshooting recommendation
			<p>properly, without requiring manual intervention.</p> <p>2. If it occurs frequently, please check whether Utility grid and voltage are within the allowable range.</p> <ul style="list-style-type: none"> • If Utility gridvoltage exceeds the permissible range, please contact the local power operator. • If Utility gridvoltage is within the allowable range, it is necessary to modify the InverterGrid Undervoltage Protection point after obtaining approval from the local power operator.LVRTEnable or disable the Grid Undervoltage Protection function. <p>3. If the issue persists for an extended period, please check whether the AC-side breaker and output cables are properly connected.</p>

fault code	fault name	fault cause	Troubleshooting recommendation
F05	10minOvervoltage Protection	In10minThe sliding average of Utility gridvoltage exceeds the safety regulation limits.	<p>1. If it occurs occasionally, it may be due to a temporary anomaly in Utility grid. Inverter will resume normal operation after detecting that Utility grid is functioning properly, without requiring manual intervention.</p> <p>2. Check if Utility gridvoltage is operating at a high voltage for an extended period. If this occurs frequently, verify whether Utility gridvoltage is within the allowable range.</p> <ul style="list-style-type: none"> • If Utility gridvoltage exceeds the permissible range, please contact the local power operator. • If the Utility gridvoltage is within the allowable range, it is necessary to obtain approval from the local power operator before modifying the Utility grid.10minOvervoltage Protection point.

fault code	fault name	fault cause	Troubleshooting recommendation
F06	Grid Overfrequency	Utility grid anomaly: Utility grid actual Frequency exceeds local Utility grid standard requirements.	<p>1. If it occurs occasionally, it may be due to a temporary abnormality in Utility grid. Inverter will resume normal operation after detecting that Utility grid is functioning properly, without requiring manual intervention.</p> <p>2. If it occurs frequently, check whether Utility grid and Frequency are within the allowable range.</p> <ul style="list-style-type: none"> • If the Utility grid Frequency exceeds the permissible range, please contact the local power operator. • If Utility grid Frequency is within the allowable range, the Grid Overfrequency point needs to be modified after obtaining consent from the local power operator.

fault code	fault name	fault cause	Troubleshooting recommendation
F07	Grid Underfrequency	Utility grid anomaly: Utility grid actual Frequency is lower than local Utility grid standard requirement.	<p>1. If it occurs occasionally, it may be due to a temporary anomaly in Utility grid. Inverter will resume normal operation upon detecting that Utility grid is functioning properly, without requiring manual intervention.</p> <p>2. If it occurs frequently, check whether Utility grid and Frequency are within the allowable range.</p> <ul style="list-style-type: none"> • If the Utility gridFrequency exceeds the permissible range, please contact the local power operator. • If the Utility gridFrequency is within the permissible range, the Grid Overfrequency point needs to be modified after obtaining consent from the local power operator.

fault code	fault name	fault cause	Troubleshooting recommendation
F08	Grid Frequency Instability	Utility grid anomaly: Utility grid actual Frequency variation rate does not comply with local Utility grid standard.	<p>1. If it occurs occasionally, it may be due to a temporary anomaly in Utility grid. Inverter will resume normal operation after detecting that Utility grid is functioning properly, without requiring manual intervention.</p> <p>2. If it occurs frequently, check whether Utility grid and Frequency are within the allowable range.</p> <ul style="list-style-type: none"> • If the Utility gridFrequency exceeds the permissible range, please contact the local power operator. • If the Utility grid Frequency is within the allowable range, please contact your dealer or after-sales service center.

fault code	fault name	fault cause	Troubleshooting recommendation
F163	Grid Phase Instability	Utility grid anomaly: Utility grid voltage phase variation rate does not comply with local Utility grid standards.	<p>1. If it occurs occasionally, it may be due to a temporary anomaly in Utility grid. Inverter will resume normal operation after detecting that Utility grid is functioning properly, without requiring manual intervention.</p> <p>2. If it occurs frequently, please check whether Utility grid and Frequency are within the allowable range.</p> <ul style="list-style-type: none"> • If Utility gridFrequency exceeds the permissible range, please contact the local power operator. • If the Utility gridFrequency is within the allowable range, please contact your dealer or after-sales service center.

fault code	fault name	fault cause	Troubleshooting recommendation
F09	Anti-islanding Protection	Utility grid has been disconnected, maintaining Utility grid voltage due to the presence of load. According to safety regulation Protection, on-grid has been stopped.	<p>1. If it occurs occasionally, it may be due to a temporary anomaly in Utility grid. Inverter will resume normal operation after detecting that Utility grid is functioning properly, without requiring manual intervention.</p> <p>2. If it occurs frequently, check whether the Utility grid and Frequency are within the allowable range.</p> <ul style="list-style-type: none"> • If the Utility gridFrequency exceeds the permissible range, please contact the local power operator. • If the Utility grid Frequency is within the allowable range, please contact your dealer or after-sales service center.
F10	Undervoltage ride-through	Utility grid anomaly: Grid Voltage Abnormal duration exceeds the specified high-low transition time.	

fault code	fault name	fault cause	Troubleshooting recommendation
F11	HVRT Overvoltage	Utility grid anomaly: The duration of Grid Voltage Abnormal exceeds the specified high-low transition time.	<p>1. If it occurs occasionally, it may be due to a temporary anomaly in Utility grid. Inverter will resume normal operation after detecting that Utility grid is functioning properly, without requiring manual intervention.</p> <p>2. If it occurs frequently, please check whether Utility grid, voltage, and Frequency are within the allowable range and stable. If not, contact the local power operator; if yes, contact your dealer or after-sales service center.</p>
F43	Grid Waveform Abnormal	Utility grid anomaly: Utility grid voltage detection triggered fault due to abnormality.	
F44	Grid Phase Loss	Utility grid anomaly: Utility gridvoltage has a single-phase dip.	

fault code	fault name	fault cause	Troubleshooting recommendation
F45	Grid Voltage Imbalance	Utility grid phase voltage deviation is excessive.	<p>1. If it occurs occasionally, it may be due to a temporary anomaly in Utility grid. Inverter will resume normal operation after detecting that Utility grid is functioning properly, without requiring manual intervention.</p> <p>2. If this occurs frequently, please check whether Utility grid, voltage, and Frequency are within the allowable range and stable. If not, contact the local power operator; if yes, contact your dealer or after-sales service center.</p>
F46	Grid Phase Sequence Failure	Inverter and Utility grid wiring abnormality: wiring is not in positive sequence	<p>1. Check whether the wiring of Inverter and Utility grid is in positive sequence. After the wiring is corrected (e.g., by swapping any two live wires), the fault will automatically disappear.</p> <p>2. If the wiring is correct and fault persists, please contact the dealer or after-sales service center.</p>

fault code	fault name	fault cause	Troubleshooting recommendation
F47	Grid Rapid Shutdown Protection	Quickly shut down the output upon detecting the Grid Power Outage operating condition.	1. Grid connected automatically disappears after fault is restored
F48	Grid Neutral Wire Loss	Phase splitting	1. The alarm automatically disappears after Grid connected recovery. 2. Check if the AC line or AC Switch is disconnected.
F160	EMS/Forced off-grid	EMSIssue forced off-grid command, but the off-grid function is not enabled.	Enable off-grid function
F161	Passive Anti-islanding Protection	-	-
F162	Grid Type Fault	Actual Type of Electrical Supply System (two-phase or split-phase) does not match the set safety regulations.	Switch the corresponding safety regulations according to the actual Type of Electrical Supply System.

fault code	fault name	fault cause	Troubleshooting recommendation
F12	30mAGfciProtection	During operation, the input-to-ground insulation resistance becomes low.	<p>1. If it occurs occasionally, it may be caused by temporary external line abnormalities. The system will resume normal operation after the fault is cleared, without requiring manual intervention.</p> <p>2. If it occurs frequently or cannot be restored for a long time, please check whether the PV String ground impedance is too low.</p>
F13	60mAGfciProtection	During operation, the input-to-ground insulation resistance becomes low.	<p>1. If it occurs occasionally, it may be caused by temporary abnormalities in the external circuit. The fault will resume normal operation after clearing without manual intervention.</p> <p>2. If the issue occurs frequently or cannot be resolved for an extended period, please check whether the PV String ground impedance is too low.</p>

fault code	fault name	fault cause	Troubleshooting recommendation
F14	150mAGfciProtection	During operation, the input-to-ground insulation resistance becomes low.	<p>1. If it occurs occasionally, it may be caused by temporary abnormalities in the external circuit. The system will resume normal operation after the fault is cleared, without requiring manual intervention.</p> <p>2. If the issue occurs frequently or cannot be resolved for an extended period, please check whether the PV String ground impedance is too low.</p>
F15	Gfcislowly varying Protection	During operation, the input-to-ground insulation resistance becomes low.	<p>1. If it occurs occasionally, it may be caused by temporary abnormalities in the external circuit. The fault will clear automatically and resume normal operation without manual intervention.</p> <p>2. If the issue occurs frequently or cannot be resolved for an extended period, please check whether the PV String ground impedance is too low.</p>

fault code	fault name	fault cause	Troubleshooting recommendation
F16	DCIPrimary Protection	The High DC Component of the inverter output current is outside the safety regulations or the default permissible range of the machine.	<ol style="list-style-type: none"> 1. If the abnormality is caused by an external fault, the Inverter will automatically resume normal operation after the fault disappears, without requiring manual intervention. 2. If this alarm occurs frequently and affects the normal power generation of the power station, please contact the dealer or after-sales service center.
F17	DCIsecondary Protection	The current of the inverter output is outside the safety regulations or the default permissible range of the machine.	<ol style="list-style-type: none"> 1. If the abnormality is caused by an external fault, the Inverter will automatically resume normal operation after the fault disappears, without requiring manual intervention. 2. If this alarm occurs frequently and affects the normal power generation of the power station, please contact the dealer or after-sales service center.

fault code	fault name	fault cause	Troubleshooting recommendation
F18	Low Insulation Resistance	<p>1. PV String is short-circuited to ground with Protection.</p> <p>2. The environment of PV String Installation is consistently humid with poor line-to-ground insulation.</p> <p>3. Batteryport line-to-ground Low Insulation Resistance.</p>	<p>1. Check the impedance between PV String/Battery port and ground Protection. A resistance value greater than 80kΩ is normal. If the measured resistance is less than 80kΩ, locate and rectify the short circuit point.</p> <p>2. Check whether the PE cable of the Inverter is properly connected.</p> <p>3. If it is confirmed that the impedance is indeed lower than the default value in rainy weather, please reset the Inverter "insulation resistance Protection point" via the App.</p> <p>In the Australian and New Zealand markets, when Inverter occurs, alarms can also be triggered through the following methods:</p> <p>1. Inverter is equipped with a buzzer, which will sound continuously for 1 minute when a fault occurs; if the fault is not resolved, the buzzer will sound again every 30 minutes.</p>

fault code	fault name	fault cause	Troubleshooting recommendation
			2. If Inverter is added to the monitoring platform and the alarm notification method is configured, alarm information can be sent to customers via email.
F19	Grounding Abnormal	<ol style="list-style-type: none"> 1. The PE cable of Inverter Not Connected. 2. When the output of PV String is grounded, the output side of Inverter is not connected with an isolation transformer. 	<ol style="list-style-type: none"> 1. Please confirm whether the Inverter of PE cable is functioning normally. 2. In the scenario where the output of PV String is grounded, please confirm whether the output side of Inverter is connected to an isolation transformer.
F49	L-PE Short Circuit	Output phase line toPELow impedance or short circuit	Detect output phase line toPEImpedance, identify Locations with low impedance and repair them.

fault code	fault name	fault cause	Troubleshooting recommendation
F50	DCVPrimary Protection	Abnormal load fluctuation	<p>1. If the abnormality is caused by an external fault, the Inverter will automatically resume normal operation after the fault disappears, without requiring manual intervention.</p> <p>2. If this alarm occurs frequently and affects the normal power generation of the power station, please contact the dealer or after-sales service center.</p>
F51	DCVSecondary Protection	Abnormal load fluctuation	<p>1. If the abnormality is caused by an external fault, the Inverter will automatically resume normal operation after the fault disappears, without requiring manual intervention.</p> <p>2. If this alarm occurs frequently and affects the normal power generation of the power station, please contact the dealer or after-sales service center.</p>

fault code	fault name	fault cause	Troubleshooting recommendation
F20	Hardware Export Limit Protection	Abnormal load fluctuation	<p>1. If the abnormality is caused by an external fault, the Inverter will automatically resume normal operation after the fault disappears, without requiring manual intervention.</p> <p>2. If this alarm occurs frequently and affects the normal power generation of the power station, please contact the dealer or after-sales service center.</p>
F21	Internal Comm Loss	Reference specific subcode reason	<p>Disconnect the AC output side switch and the DC input side switch.5 After a few minutes, close the AC output side switch and the DC input side switch. If fault persists, please contact the dealer or after-sales service center.</p>
F52	Leakage currentGFCIMultiple fault shutdowns	North American safety standards require that after multiple fault, the system must not recover automatically and requires manual intervention or waiting.24hPost-recovery	<p>1. Please check if the PV String ground impedance is too low.</p>

fault code	fault name	fault cause	Troubleshooting recommendation
F53	DC Arc Failure AFCI Multiple fault shutdowns	North American safety regulations require that after multiple fault, the system must not recover automatically and requires manual intervention or waiting. 24h Post-recovery	<ol style="list-style-type: none"> 1. After the machine is re-on-grid, check whether the voltage current of each circuit abnormally decreases to zero; 2. Check if the DC side terminal is securely connected.
F54	External communication link failure	External device communication lost, possibly due to peripheral power supply issues, Communication Protocols mismatch, or unconfigured corresponding peripherals.	Judgment is made based on the actual model and detection enable bits; peripherals not supported by certain models will not be detected.
F55	Back-upport Overload fault	1. Prevent Inverter from continuous Overload output.	1. Disconnect some off-grid loads to reduce the Inverter off-grid output Power.

fault code	fault name	fault cause	Troubleshooting recommendation
F56	Back-upport overvoltage fault	2. Prevent damage to the load caused by overvoltage in the Inverter output.	1. If it occurs occasionally, it may be caused by load switching and does not require manual intervention. 2. If it occurs frequently, please contact the dealer or after-sales service center.
F107	On-grid PWM Sync Failure	Abnormal occurrence in carrier synchronization on-grid	1Check if the synchronization line connection is normal. 2Check if the master-slave settings are normal. 3Disconnect the AC output side switch and the DC input side switch. 5 After a few minutes, close the AC output side switch and the DC input side switch. If fault persists, please contact the distributor or after-sales service center.
F57	External connectionBoxfault	waiting for Switch On-Grid to Off-GridBoxExcessive relay switching time	1. InspectionBoxIs it functioning properly; 2. InspectionBoxIs the communication wiring correct;
-	Generator Failure		

fault code	fault name	fault cause	Troubleshooting recommendation
F22	Generator waveform detection fault	<p>1. In the case of a Not Connected generator, this fault will always be displayed.</p> <p>2. During generator operation, failure to meet generator safety regulations will trigger this fault.</p>	<p>1. When the generator is not connected, ignore this fault;</p> <p>2. The occurrence of this fault when the generator experiences fault is normal. After the generator recovers, wait for a period of time, and the fault will automatically clear.</p> <p>3. The fault does not affect the normal operation of the off-grid mode.</p> <p>4. The generator and Utility grid are connected simultaneously and meet safety requirements. Utility grid takes priority on-grid and will operate in the Utility grid on-grid state.</p>
F23	Abnormal generator connection		
F24	Generator voltage low		
F25	Generator voltage high		
F26	Generator Frequency low		
F27	Generator Frequency high		
F109	External connectionSTSfault	Inverter andSTSAbnormal connection cable	Check the Inverter andSTSIs the wiring sequence of the harness connection between them one-to-one and sequentially corresponding?
F58	CTMissing fault	CTConnection wire disconnected (Japanese safety regulation requirement)	InspectionCTIs the wiring correct.

fault code	fault name	fault cause	Troubleshooting recommendation
F110	Export Limit Protection	1. Fault report and grid disconnection 2. meterUnstable communication 3. Reverse power flow condition occurs	1. Check if there are any other error messages in Inverter. If so, perform targeted troubleshooting. 2. InspectionmeterIs the connection reliable? 3. If this alarm occurs frequently and affects the normal power generation of the power station, please contact the dealer or after-sales service center.
F111	BypassOverload	-	-
F112	Black Start Failure	-	-
F28	Parallel operationIOSelf-test abnormality	Parallel communication line is not securely connected or parallel operationIOChip damage	Check if the parallel communication cable is securely connected, and then recheck.IOCheck if the chip is damaged, and if so, replace it.IOChip.
F59	Parallel operationCANComm unication abnormality	Parallel communication cable is not securely connected or some units are offline.	Check whether all machines are power on and ensure the parallel communication cables are securely connected.

fault code	fault name	fault cause	Troubleshooting recommendation
F29	Paralell Grid Line Reversed	Some machines have the Utility grid line connected in reverse with others.	Reconnect the Utility grid line.
F60	Parallel operationBack-upreverse connection	Partial machinesbackupLine reversed with other connections	reconnectionbackupLine.
F61	Inverter Soft Start Failure	Off-grid cold start Inverter Soft Start Failure	Check whether the inverter module of the machine is damaged.
F113	Offgrid AC Ins Volt High	-	-
F30	AC HCT check Abnormal	AC sensor sampling anomaly	Disconnect the AC output side switch and the DC input side switch. ⁵ After a few minutes, close the AC output side switch and the DC input side switch. If fault persists, please contact the distributor or after-sales service center.
F62	AC HCT Failure	HCTSensor anomaly detected	Disconnect the AC output side switch and the DC input side switch. ⁵ After a few minutes, close the AC output side switch and the DC input side switch. If fault persists, please contact the distributor or after-sales service center.

fault code	fault name	fault cause	Troubleshooting recommendation
F31	GFCI HCT Check Abnormal	Leakage current sensor has sampling abnormality	Disconnect the AC output side switch and the DC input side switch.5 After a few minutes, close the AC output side switch and the DC input side switch. If fault persists, please contact the distributor or after-sales service center.
F63	GFCI HCT Failure	Leakage current sensor is abnormal	Disconnect the AC output side switch and the DC input side switch.5 After a few minutes, close the AC output side switch and the DC input side switch. If fault persists, please contact the distributor or after-sales service center.
F32	Relay Check Abnormal	Relay abnormality, cause: 1Relay abnormality (relay short circuit) 2Relay sampling circuit abnormality. 3Abnormal AC side wiring (possible loose connection or short circuit)	Disconnect the AC output side switch and the DC input side switch.5 After a few minutes, close the AC output side switch and the DC input side switch. If fault persists, please contact the distributor or after-sales service center.

fault code	fault name	fault cause	Troubleshooting recommendation
F64	Relay Failure	1Relay abnormality (relay short circuit) 2Relay sampling circuit abnormality. 3Abnormal AC side wiring (possible loose connection or short circuit)	Disconnect the AC output side switch and the DC input side switch.5 After a few minutes, close the AC output side switch and the DC input side switch. If fault persists, please contact the distributor or after-sales service center.
F164	String (array)17~32)	1DC side connection terminal loose; 2DC side connection terminal loose contact; 3Core damage and poor contact	1After the machine is re-on-grid, check whether the voltage current of each circuit is abnormally reduced to zero; 2Check if the DC-side terminal is securely connected.
F165	String33~48)	1DC side connection terminal loose; 2DC side connection terminal loose contact; 3Core damage and poor contact	1After the machine is re-on-grid, check whether the voltage current of each circuit is abnormally reduced to zero. 2Check if the DC-side terminal is securely connected.
F33	FlashRead/Write Error	Possible causes: flashContent has been changed; flashEnd of life	1. Upgrade to the latest version of the program 2. Contact the dealer or after-sales service center.

fault code	fault name	fault cause	Troubleshooting recommendation
F42	String (string)1~16)	1DC side connection terminal loose; 2DC side connection terminal loose contact; 3Core damage and poor contact	1After the machine is re-on-grid, check whether the voltage current of each circuit is abnormally reduced to zero; 2Check if the DC-side terminal is securely connected.
F34	AFCI Check Failure	During the Arc Failure self-test process, the Arc Failure module failed to detect Arc Failure.	Disconnect the AC output side switch and the DC input side switch.5 After a few minutes, close the AC output side switch and the DC input side switch. If fault persists, please contact the distributor or after-sales service center.
F65	AC Terminal Overtemperature	AC Terminal Overtemperature, possible causes: 1Inverter Installation Location Non-ventilated. 2Ambient Overtemperature 3Internal fan operation abnormal.	

fault code	fault name	fault cause	Troubleshooting recommendation
F35	Cabinet Overtemperature	Cabinet Overtemperature, Possible causes: 1 Inverter Installation Location non-ventilated. 2 Ambient Overtemperature 3 Internal fan operation abnormal.	1 Check whether the ventilation of the Inverter Installation Location is adequate and whether the ambient temperature exceeds the maximum permissible ambient temperature range. 2 If there is no ventilation or Ambient
F66	INV Module temperature too high	Inverter module temperature is too high, possible causes: 1 Inverter Installation Location non-ventilated. 2 Ambient Overtemperature 3 Internal fan operation abnormal.	Overtemperature, please improve the ventilation and heat dissipation conditions. 3 If ventilation and ambient temperature are both normal, please contact the dealer or after-sales service center.

fault code	fault name	fault cause	Troubleshooting recommendation
F67	BoostModule temperature too high	BoostModule temperature too high, possible causes: 1 Inverter Installation Location non-ventilated. 2 Ambient Overtemperature 3 Internal fan operation abnormal.	
F68	AC Capacitor Overtemperature	Output filter capacitor temperature is too high, possible causes: 1 Inverter Installation Location not ventilated. 2 Ambient Overtemperature 3 Internal fan operation abnormal.	

fault code	fault name	fault cause	Troubleshooting recommendation
F114	Relay Failure ²	Relay abnormality, cause: 1 Relay abnormality (relay short circuit) 2 Relay sampling circuit abnormality. 3 Abnormal AC side wiring (possible loose connection or short circuit)	Disconnect the AC output side switch and the DC input side switch. ⁵ After a few minutes, close the AC output side switch and the DC input side switch. If fault persists, please contact the distributor or after-sales service center.
F69	PV IGBT short circuit	Possible causes: 1. IGBT short circuit 2. Abnormal sampling circuit	Disconnect the AC output side switch and the DC input side switch. ⁵ After a few minutes, close the AC output side switch and the DC input side switch. If fault persists, please contact the distributor or after-sales service center.
F70	PV IGBT open circuit voltage	1. Software issue caused no wave transmission. 2. Drive circuit abnormality: 3. IGBT Open Circuit	Disconnect the AC output side switch and the DC input side switch. ⁵ After a few minutes, close the AC output side switch and the DC input side switch. If fault persists, please contact the distributor or after-sales service center.

fault code	fault name	fault cause	Troubleshooting recommendation
F71	NTC abnormal	NTC Temperature sensor abnormality detected	Disconnect the AC output side switch and the DC input side switch.5 After a few minutes, close the AC output side switch and the DC input side switch. If fault persists, please contact the distributor or after-sales service center.
F72	PWM Abnormal	PWM Abnormal waveform detected	Disconnect the AC output side switch and the DC input side switch.5 After a few minutes, close the AC output side switch and the DC input side switch. If fault persists, please contact the distributor or after-sales service center.
F73	CPU Interruption anomaly	CPU Interruption anomaly occurred	Disconnect the AC output side switch and the DC input side switch.5 After a few minutes, close the AC output side switch and the DC input side switch. If fault persists, please contact the distributor or after-sales service center.
F74	Microelectronics fault	Function Safety anomaly detected	Disconnect the AC output side switch and the DC input side switch.5 After a few minutes, close the AC output side switch and the DC input side switch. If fault persists, please contact the distributor or after-sales service center.

fault code	fault name	fault cause	Troubleshooting recommendation
F75	PV HCTfault	boostcurrent sensor abnormality	Disconnect the AC output side switch and the DC input side switch.5 After a few minutes, close the AC output side switch and the DC input side switch. If fault persists, please contact the distributor or after-sales service center.
F76	1.5VBenchmark anomaly	Reference circuit	Disconnect the AC output side switch and the DC input side switch.5 After a few minutes, close the AC output side switch and the DC input side switch. If fault persists, please contact the distributor or after-sales service center.
F77	0.3VBaseline anomaly	Reference circuit	
F78	CPLDVersion identification error	CPLDVersion identification error	Disconnect the AC output side switch and the DC input side switch.5 After a few minutes, close the AC output side switch and the DC input side switch. If fault persists, please contact the distributor or after-sales service center.
F79	CPLDCommunication fault	CPLDandDSPCommunication content error or timeout	Disconnect the AC output side switch and the DC input side switch.5 After a few minutes, close the AC output side switch and the DC input side switch. If fault persists, please contact the distributor or after-sales service center.

fault code	fault name	fault cause	Troubleshooting recommendation
F80	Model Identification	Model Recognition Error's fault regarding	Disconnect the AC output side switch and the DC input side switch.5 After a few minutes, close the AC output side switch and the DC input side switch. If fault persists, please contact the distributor or after-sales service center.
F115	SVGPrecharge Disabled	SVGPrecharge hardware failure	Contact the dealer or after-sales service center.
F116	nighttimeSVG PIDPrevention of fault	PIDPrevent hardware anomalies	Contact the dealer or after-sales service center.
F117	DSPVersion identification error	DSPSoftware version identification error	Disconnect the AC output side switch and the DC input side switch.5 After a few minutes, close the AC output side switch and the DC input side switch. If fault persists, please contact the distributor or after-sales service center.
F36	Bus Overvoltage		Disconnect the AC output side switch and the DC input side switch.5 After a few minutes, close the AC output side switch and the DC input side switch. If fault persists, please contact the distributor or after-sales service center.
F81	P-Bus Overvoltage		
F82	N-Bus Overvoltage		
F83	Bus Overvoltage(Deputy CPU1)		
F84	DeputyCPU1)		

fault code	fault name	fault cause	Troubleshooting recommendation
F85	DeputyCPU1)	BUSOvervoltage, possible causes: 1. PVvoltage too high 2InverterBUSSampling anomaly 3The poor isolation effect of the rear-end double splitting causes mutual interference between the two Inverteron-grid, resulting in DC overvoltage when one of the Inverteron-grid occurs.	
F86	Bus Overvoltage(Deputy CPU2)		
F87	DeputyCPU2)		
F88	N-Bus Overvoltage(Deputy CPU2)		
F89	P-Bus Overvoltage(CPLD)		
F90	Complex Programmable Logic Device (CPLD)		
F118	MOSContinuous Overvoltage	1. Software issue causes the inverter drive to shut down earlier than the flyback drive. 2. Inverter drive circuit abnormality prevents turn-on. 3. PVvoltage too high 4. MosSampling anomaly	Disconnect the AC output side switch and the DC input side switch.5 After a few minutes, close the AC output side switch and the DC input side switch. If fault persists, please contact the distributor or after-sales service center.

fault code	fault name	fault cause	Troubleshooting recommendation
F119	Busbar short circuit	1. Hardware damage	In case of occurrence BUS After a short circuit fault, the Inverter remains in an off-grid state. Please contact the dealer or after-sales service center.
F120	Abnormal bus sampling	1. Bus Sampling hardware	Disconnect the AC output side switch and the DC input side switch.5 After a few minutes, close the AC output side switch and the DC input side switch. If fault persists, please contact the distributor or after-sales service center.
F121	DC Lateral sampling abnormality	1. Bus sampling hardware 2. Battery Voltage Sampling Hardware fault 3. Dc rly Relay Failure	Disconnect the AC output side switch and the DC input side switch.5 After a few minutes, close the AC output side switch and the DC input side switch. If fault persists, please contact the distributor or after-sales service center.

fault code	fault name	fault cause	Troubleshooting recommendation
F37	PVInput overvoltage	PVvoltage input too high, possible causes: Incorrect PV array configuration, with too many PV Battery panels connected in series, causing the open-circuit voltage of the string to exceed the maximum operating voltage of the Inverter.	Check the series configuration of the corresponding PV array strings to ensure that the open-circuit voltage of the strings does not exceed the maximum working voltage of the Inverter. Once the PV array is correctly configured, the Inverter alarm will automatically disappear.
F38	PVContinuous Hardware Overcurrent	1. Unreasonable module configuration 2. Hardware damage	Disconnect the AC output side switch and the DC input side switch.5After a few minutes, close the AC output side switch and the DC input side switch. If fault persists, please contact the distributor or after-sales service center.
F39	PVContinuous software overcurrent	1. Unreasonable module configuration 2. Hardware damage	
F91	FlyCap Software Overvoltage	Flying capacitor overvoltage, possible causes: 1. PVvoltage too high 2Inverter Flying Capacitor voltage Sampling Anomaly	

fault code	fault name	fault cause	Troubleshooting recommendation
F92	FlyCap Hardware Overvoltage	Flying capacitor overvoltage, possible causes: 1. PVvoltage too high 2InverterFlying capacitorvoltageSa mpling anomaly	Disconnect the AC output side switch and the DC input side switch.5After a few minutes, close the AC output side switch and the DC input side switch. If fault persists, please contact the distributor or after-sales service center.
F93	FlyCap Undervoltage	FlyCap Undervoltage, possible causes: 1. PVEnergy deficiency; 2Flying capacitor sampling anomaly	
F94	FlyCap Precharge Failure	FlyCap Precharge Failure, Possible causes: 1. PVEnergy deficiency; 2InverterFlying CapacitorvoltageSa mpling Anomaly	
F95	FlyCap Precharge Abnormal	1. Unreasonable control loop parameters 2. Hardware damage	
F96	String overcurrent(String1 ~16)		

fault code	fault name	fault cause	Troubleshooting recommendation
F97	String overcurrent(String17~32)	Possible causes: 1. String Overcurrent 2. String current sensor anomaly	
F40	String reverse connection(String1~16)	PVString reverse connection	Check if the strings are reversed.
F98	String reverse connection(String17~32)	PVString reverse connection	Check if the string is reverse connected.
F99	String loss(String1~16)	String fuse disconnected (if applicable)	Check if the fuse is blown.
F100	String loss(String17~32)	String fuse disconnected (if applicable)	Check if the fuse is blown.

fault code	fault name	fault cause	Troubleshooting recommendation
F122	PVAccess Mode setting error	<p>PVAccess Mode has three modes, with four channelsMPPTFor example:</p> <ol style="list-style-type: none"> 1. Parallel mode: that isAAAAMode(homologous mode),PV1-PV4Homologous,4RoadPVConnect the same photovoltaic panel 2. Partial Parallel Mode: i.e.AACCMode,PV1 andPV2Homologous connection,PV3and PV4homologous connection 3. Stand-alone mode: i.e.ABCDMode(non-homologous),PV1、PV2、PV3、PV4Independent connection,4RoadPVEach connected to a photovoltaic panel <p>IfPVThe actual Access Mode and the equipment</p>	<p>InspectionPVIIs Access Mode correctly set (ABCD、AACC、AAAAReset in the correct mannerPVAccess Mode</p> <ol style="list-style-type: none"> 1. Confirm the actual connected circuitsPVIIs the connection correct. 2. IfPVCorrectly connected, passedAppor screen to check the current settingsPVAccess Mode" corresponds to the actual Access Mode. 3. If the currently setPVAccess Mode" does not match the actual Access Mode and requires adjustment.Appor the screen willPVAccess Mode is set to a mode consistent with actual conditions. After the setting is completed,PVandACPower supply disconnection and restart. 4. After the setup is completed, if the currentPVAccess Mode matches the actual Access Mode, but this fault is still reported. Please contact the dealer or after-sales

fault code	fault name	fault cause	Troubleshooting recommendation
		settingsPVThis fault will be reported if Access Mode does not match.	service center.
-	String reverse connection(String33~48)	PVString reverse connection	Check if the strings are reversed.
-	String loss(String33~48)	String fuse disconnected (if applicable)	Check if the fuse is blown.
-	String overcurrent(String33~48)	Possible causes: 1. String Overcurrent 2. String current sensor anomaly	

fault code	fault name	fault cause	Troubleshooting recommendation
F123	Multi-channel PV phase error	PV input mode setting error	<p>Check if the PVAccess Mode is correctly set (ABCD, AACC, AAAA), and reset the PVAccess Mode in the correct manner. Verify that each connected PV string is correctly wired.</p> <p>2. If the PV is correctly connected, check via the App or screen whether the currently set "PVAccess Mode" corresponds to the actual Access Mode.</p> <p>3. If the currently set "PV Access Mode" does not match the actual Access Mode, it is necessary to use the App or screen to set the "PV Access Mode" to the mode consistent with the actual situation. After the setting is completed, disconnect the PV and AC power supply and restart.</p> <p>4. After the setup is completed, if the current "PVAccess Mode" matches the actual Access Mode but this fault still appears, please contact the dealer or after-sales service center.</p>

fault code	fault name	fault cause	Troubleshooting recommendation
F101	Battery1Precharge fault	Battery1Pre-Charge circuit fault (such as pre-Charge resistance burnout, etc.)	Check if the pre-Charge circuit is in good condition, ensure that only the Battery power on matches the Battery Voltage and busbar voltage. If they do not match, please contact the dealer or after-sales service center.
F102	Battery1Relay Failure	Battery1The relay fails to operate normally.	After Battery power on, check whether the Battery relay operates and if the closing sound is heard. If it does not function, please contact the dealer or after-sales service center.
F103	Battery1overvoltage at connection point	Battery1The voltage access exceeds the rated range of the machine.	Verify if Battery Voltage is within the machine's rated range.
F104	Battery2Precharge fault	Battery2Pre-Charge circuit fault (such as pre-Charge resistor burnout, etc.)	Check whether the pre-Charge circuit is in good condition, and verify that the Battery power on post-Battery Voltage matches the busbar voltage. If they do not match, please contact the dealer or after-sales service center.

fault code	fault name	fault cause	Troubleshooting recommendation
F105	Battery2Relay Failure	Battery2The relay fails to operate normally.	After Battery power on, check if the Battery relay operates and if the closing sound is heard. If it does not function, please contact the dealer or after-sales service center.
F106	Battery2overvoltage at connection point	Battery2The input voltage exceeds the rated range of the machine.	Verify if Battery Voltage is within the machine's rated range.
F124	Battery1Reverse connection	Battery1Reverse polarity of positive and negative terminals	Check whether the polarity of Battery and the machine terminal is consistent.
F125	Battery2Reverse polarity fault	Battery2Reverse polarity of positive and negative terminals	Check whether the polarity of Battery and the machine terminals is consistent.
F126	Abnormal Access	Abnormal connection of Battery	Check if the Battery is functioning properly.
-	BMS Status Bit Error	BMS Module	Disconnect the AC output side switch and DC input side switch, then close the AC output side switch and DC input side switch after 5 minutes. If fault persists, please contact the distributor or after-sales service center.

fault code	fault name	fault cause	Troubleshooting recommendation
F127	BAT Overtemperature	Battery temperature is too high, possible causes: 1 Inverter Installation Location non-ventilated. 2 Ambient Overtemperature 3 Internal fan operation abnormal.	
F128	Ref Voltage Abnormal	Reference circuit	Disconnect the AC output side switch and the DC input side switch.5 After a few minutes, close the AC output side switch and the DC input side switch. If fault persists, please contact the distributor or after-sales service center.
F129	Cabinet Under Temperature	Cabinet Under Temperature, Possible causes: 1. The ambient temperature is too low.	
F130	ACsideSPDfault	ACFailure of lateral lightning protection device	ReplacementACLateral lightning protection device.
F131	DCsideSPDfault	DCFailure of lateral lightning protection device	ReplacementDCSide lightning protection device.

fault code	fault name	fault cause	Troubleshooting recommendation
F132	Internal Fan Abnormal	Internal Fan Abnormal, possible causes: 1Abnormal fan power supply; 2Mechanical fault(Locked rotor); 3Fan aging and damage.	Disconnect the AC output side switch and the DC input side switch.5 After a few minutes, close the AC output side switch and the DC input side switch. If fault persists, please contact the distributor or after-sales service center.
F133	External Fan Abnormal	External Fan Abnormal, Possible causes: 1Abnormal fan power supply; 2Mechanical fault(Locked rotor); 3Fan aging and damage.	
F134	PIDDiagnose abnormality	PIDHardware fault orPVvoltage too highPIDPause	PVOvertoltage caused by voltagePIDSuspend WARNING without processing,PIDHardware fault can be turned off.PIDSwitch Reopen ClearPIDfault, replacementPIDdevice

fault code	fault name	fault cause	Troubleshooting recommendation
F135	Trip-Switch Trip Warning	Possible causes: Overcurrent or PVReverse connection causes the trip switch to trip.	Please contact the dealer or after-sales service center. The reason for disconnection is due to a fault occurrence. PVShort circuit or reverse connection, need to check if there is a history. PVShort circuit WARNING or history PVReverse connection of WARNING. If present, maintenance personnel should inspect the corresponding component. PV Situation. After confirming there is no fault, manually close the trip switch and proceed with AppInterface Clear History fault Operation Clears This WARNING.

fault code	fault name	fault cause	Troubleshooting recommendation
F136	HistoryPV IGBT short circuit	Possible causes: Overcurrent caused the trip switch to open.	Please contact the dealer or after-sales service center. Maintenance personnel should follow the historicalPVShort circuit WARNING subcode, check for short circuit occurrenceBoostCheck if there is any fault in the hardware and external string; after confirming there is no fault, it can pass.AppInterface Clear History fault Operation Clears This WARNING.
F137	HistoryPVReverse connection WARNING(String1~16)	Possible causes: occurrencePVReverse connection causes the trip switch to trip.	Contact the dealer or after-sales service center. Maintenance personnel should follow the historicalPVReverse polarity WARNING subcode, check whether the corresponding string has reverse polarity, inspectPVIIs there a voltage difference in the panel configuration? After the inspection is completed and no fault is found, it can be passed.AppInterface Clear History fault Operation Clears This WARNING.

fault code	fault name	fault cause	Troubleshooting recommendation
F138	HistoryPVReverse connection(String17~32)	Possible causes: occurrencePVReverse connection causes the trip switch to trip.	Contact the dealer or after-sales service center. Maintenance personnel must follow the historicalPVReverse connection WARNING subcode, check whether the corresponding string has a reverse connection, inspectPVIIs there a voltage difference in the panel configuration? After checking and confirming no fault, it can be passed.AppInterface Clear History fault Operation Clears This WARNING.
F139	FlashRead/write error	Possible causes: flashContent has been changed;flashEnd of life	<ol style="list-style-type: none"> 1. Upgrade to the latest version of the program. 2. Contact the dealer or after-sales service center.

fault code	fault name	fault cause	Troubleshooting recommendation
F140	Meter Comm Loss	This WARNING may only be reported after enabling the Power Limit function. Possible causes: 1. Meter not connected; 2. The communication line connection between the meter and Inverter is incorrect.	Check the meter wiring and ensure the meter is correctly connected. If fault persists after inspection, please contact the dealer or after-sales service center.
F141	PVPanel type identification failed	PVPanel identification hardware anomaly	Contact the dealer or after-sales service center.
F142	PV String Mismatch	PVPV String Mismatch, same circuitMPPTThe configurations of the next two strings open-circuit voltage are different.	Check the two strings open-circuit voltage and configure the strings with the same open-circuit voltage to the same circuit.MPPTProlonged PV String Mismatch poses safety hazards.
F143	CTNot connected	CTNot connected	InspectionCTWiring.
F144	CTReverse connection	CTReverse connection	InspectionCTWiring.
F145	PE Loss/PE Loss	Ground wire not connected	Check the ground wire.

fault code	fault name	fault cause	Troubleshooting recommendation
F146	String terminal temperature high(String1~8)	37176RegisterPVterminal temperature alarm subcode1Set	-
F147	String terminal temperature high(String9~16)	37177RegisterPVterminal temperature alarm subcode2Set	-
F148	String terminal temperature high(String17~20)	37178registerPVterminal temperature alarm subcode3Set position	-
F149	HistoryPVReverse connection WARNING(String33~48)	Possible causes: occurrencePVReverse connection causes the trip switch to trip.	Please contact the dealer or after-sales service center; maintenance personnel must follow the history.PVReverse connection WARNING subcode, check whether the corresponding string has a reverse connection, inspectPVIIs there a voltage difference in the panel configuration? After checking and confirming no fault, it can be passed.AppInterface Clear History fault Operation Clears This WARNING.
F150	Battery1voltage low	Battery Voltage is below the set value	-
F151	Battery2voltage low	Battery Voltage is below the set value	-
F152	Low Voltage of Battery Power	Non-Charge mode, voltage below shutdown voltage	-

fault code	fault name	fault cause	Troubleshooting recommendation
F153	BAT1 Voltage High	-	-
F154	Battery2voltageHigh	-	-
F155	Online Low Insulation Resistance	<p>PV String is short-circuited to ground with Protection.</p> <p>2. The environment of PV StringInstallation is consistently humid with poor line-to-ground insulation.</p>	<p>1. Check the impedance between PV String and ground. If a short circuit is found, rectify the short circuit point.</p> <p>2. Check whether the PE cable of the Inverter is properly connected.</p> <p>3. If it is confirmed that the impedance is indeed lower than the default value under rainy or cloudy conditions, please reset the "insulation resistanceProtection point".</p>
F156	Micro-grid Overload Warning	Excessive input at the backup end	Occasional occurrences require no action; if this alarm appears frequently, please contact the dealer or after-sales service center.
F157	Manual Reset	-	-
F158	Generator Phase Sequence Abnormal	-	-

fault code	fault name	fault cause	Troubleshooting recommendation
F159	Multiplexed Port Configuration Abnormal	Reuse (Generator) port configured as a microgrid or large load, but actually connected to a generator.	Use the App to modify the reuse (generator) port configuration.
F41	Generator Port Overload	<ol style="list-style-type: none"> 1. Off-grid side output exceeds the requirements specified in the specification. 2. Off-grid side short circuit 3. Off-grid terminal voltage too low 4. When used as a high-power load port, the load exceeds the specifications stated in the datasheet. 	By verifying the data, confirm the output parameters such as voltage, current, and Power on the off-grid side to identify the cause of the issue.
F108	DSP Communication Failure	-	-

fault name	fault cause	Troubleshooting recommendation
Parallel Comm Timeout Shutdown	In parallel operation, if the slave unit exceeds 400ms No communication from the host within seconds	Check whether the parallel communication harness is securely connected and verify that there are no duplicate slave addresses.
One-key shutdown and stop	Check if the one-touch shutdown function is enabled via the App.	Deactivate one-touch shutdown.
Offline Shutdown	-	-
Remote shutdown	-	-
Child Node Communication Failure	Internal Comm Abnormal	Restart the machine and observe whether fault is eliminated.
DG Communication Failure	Abnormal communication link between the control board and the diesel generator	<ol style="list-style-type: none"> 1. Check the link communication harness and observe whether fault is eliminated. 2. Attempt to restart the machine and observe whether the fault is eliminated; 3. If the fault persists after restarting, please contact the after-sales service center.
Battery Over Voltage	<ol style="list-style-type: none"> 1. The voltage of a single cell is too high. 2. Abnormal voltage collection line 	

fault name	fault cause	Troubleshooting recommendation
	Battery total pressure too high 2. Abnormal voltage collection line	Record the fault phenomenon, restart the Battery, wait for a few minutes, and confirm whether the fault disappears. If the problem persists after restarting, please contact the after-sales service center.
Battery Undervoltage	1. Single cell voltage too low 2. voltage Acquisition Line Anomaly	
	1. Battery Total pressure too low 2. Abnormal voltage collection line	
Battery Overcurrent	1. Charging Current is too large, Battery current limiting is abnormal: temperature and voltage value suddenly change 2. Inverter response anomaly	
	Battery discharge current is too large	
Battery Overtemperature	1. Ambient Overtemperature 2. Temperature sensor abnormality	
	1. Ambient Overtemperature 2. Temperature sensor abnormality	
Battery Undertemperature	1. Ambient temperature is too low 2. Temperature sensor abnormality	
	1. Ambient temperature is too low 2. Temperature sensor abnormality	
Battery Terminal Overtemperature	Pole temperature too high	

fault name	fault cause	Troubleshooting recommendation
Battery Imbalance	<ol style="list-style-type: none"> 1. Excessive temperature difference in different stages. Battery will impose restrictions on Battery Power, that is, limit the charging of Discharge current. Therefore, this issue is generally unlikely to occur. 2. The capacity of the battery cell degrades, leading to excessive internal resistance, resulting in significant temperature rise and large temperature differences during Overcurrent. 3. Poor welding of battery cell tabs, leading to excessive temperature rise in the Overcurrent cell. 4. Temperature sampling issue; 5. Loose power cable connection 	
	<ol style="list-style-type: none"> 1. Inconsistent aging levels of battery cells 2. Issues with the board chips can also lead to excessive voltage differences in the battery cells. 3. Imbalance issues in the battery pack can also lead to excessive voltage differences between cells. 4. Harness issues leading to 	
	<ol style="list-style-type: none"> 1. Inconsistent aging levels of battery cells 2. Issues with the board chips can also lead to excessive voltage differences between battery cells. 3. Imbalance issues in the board can also lead to excessive voltage differences between cells. 4. Harness issue causing 	

fault name	fault cause	Troubleshooting recommendation
Insulation Resistance	Insulation resistance failure	Check if the ground wire is properly connected and restart the Battery. If the issue persists after restarting, please contact the after-sales service center.
Pre-charging Failurefault	Pre-charging Failure	It indicates that during the precharge process, the voltage across the precharge MOS always exceeds the specified threshold. After restarting the system, observe whether this fault persists, and check whether the wiring is correct and whether the precharge MOS is damaged.
Harvesting line	Collection line Battery is disconnected or broken	Check the wiring and restart the Battery. If the issue persists after restarting, please contact the after-sales service center.
	Single voltage collection line poor contact or disconnected	Check the wiring and restart the Battery. If the issue persists after restarting, please contact the after-sales service center.
	Single cell temperature acquisition line poor contact or disconnected	
	Dual-channel current comparison error is too large, or current acquisition line circuit is abnormal.	

fault name	fault cause	Troubleshooting recommendation
	Dual-channel voltage comparison error is too large, or the comparison error between MCU and AFE voltage is too large, or the voltage acquisition line loop is abnormal.	
	Temperature acquisition line circuit abnormal or poor contact, disconnected	
	Overvoltage level 5 or overtemperature level 5, fuse the three-terminal fuse	To replace the three-section fuse, please contact the after-sales service center to replace the main control board.
Relay or MOSFET overtemperature	Relay or MOSFET overtemperature	The fault indicates that the MOSFET temperature has exceeded the specified threshold. Power off and let it stand for 2 hours to allow temperature recovery.
Shunt Over-temperature	Shunt Over-temperature	The fault indicates that the shunt tube temperature has exceeded the specified threshold. Power off and allow it to stand for 2 hours to wait for temperature recovery.

fault name	fault cause	Troubleshooting recommendation
BMS1 Other fault1 (Residential Storage Category)	Relay or MOS open circuit	<ol style="list-style-type: none"> 1. Upgrade the software, power off and let it sit for 5 minutes, then check if fault persists after restarting. 2. If the issue persists, replace the Battery package.
	Relay or MOSFET short circuit	<ol style="list-style-type: none"> 1. Upgrade the software, power off and let it sit for 5 minutes, then check if fault persists after restarting. 2. If the issue persists, replace the Battery package.
	Communication abnormality between the master cluster and slave cluster, or inconsistency of battery cells between clusters.	<ol style="list-style-type: none"> 1. Check the Battery information and software version of the slave unit, as well as whether the communication line connection with the master unit is normal. 2. Upgrade the software
	Abnormal circuit harness in Battery system, resulting in no loop formation in interlocking signal	Check if Terminal resistor Installation is correct

fault name	fault cause	Troubleshooting recommendation
	Abnormal communication between BMS and PCS	<ol style="list-style-type: none"> 1. Verify that the communication line interface definition between Inverter and Battery is correct. 2. Please contact the after-sales service center to check the backend data and verify whether the Inverter and Battery software are correctly matched.
	Abnormal communication harness between BMS master and slave control	<ol style="list-style-type: none"> 1. Check the wiring and restart the Battery; 2. Upgrade the Battery. If the issue persists after restarting, please contact the after-sales service center.
	Communication loss between main and auxiliary chips	
	Circuit breaker, shunt trip abnormality	<p>Let the system stand powered off for 5 minutes, then restart and check if fault persists.</p> <ol style="list-style-type: none"> 2. Check whether the blind mating connectors and communication pins at the bottom of the PACK and PCU are loose or misaligned.

fault name	fault cause	Troubleshooting recommendation
	MCU self-test failed	Upgrade the software and restart the Battery. If the issue persists after restarting, contact the after-sales service center.
	<ol style="list-style-type: none"> 1. The software version is too low or the BMS board is damaged. 2. The number of Inverter parallel units is large, and the Battery experiences excessive impact during pre-charging. 	<ol style="list-style-type: none"> 1. Upgrade the software and observe whether fault persists. 2. In the case of parallel operation, perform a black start on Battery before starting Inverter.
	Internal fault of MCU	Upgrade the software and restart the Battery. Typically, this issue is caused by a damaged MCU or external component. If the problem persists after restarting, please contact the after-sales service center.
	Total control current exceeds the specified threshold	<ol style="list-style-type: none"> 1. Let the system stand idle for 5 minutes, then restart and check if fault persists. 2. Check if the Inverter is set with an excessively large Power, causing it to exceed the bus load.

fault name	fault cause	Troubleshooting recommendation
	Cell inconsistency in parallel clusters	Confirm whether the cells in the cluster Battery are consistent.
	Cluster Battery reverse polarity of positive and negative terminals	Check whether the positive and negative terminals of the string combiner Battery are reversed.
	Severe overheating or overvoltage triggers the fire protection system.	Contact the after-sales service center.
Air Conditioner Failure	Abnormal failure of air conditioning	Try restarting the system. If the fault persists, please contact the after-sales service center.
	Cabinet door not closed	Check whether the cabinet door is properly closed.
	Power supply voltage overvoltage	Verify that the power supply voltage value meets the air conditioning input voltage requirements, and proceed with re-power on only after confirmation.
	Insufficient power supply	
	No voltage input	
	Unstable power supply voltage	Try restarting the system. If the fault persists, please contact the after-sales service center.
	Compressor instability	
	Sensor poor contact or damaged	
Abnormal air conditioning fan		

fault name	fault cause	Troubleshooting recommendation
BMS1 Other fault2 (Residential Storage Category)	There is an internal voltage or current abnormality in the DCDC.	Please refer to the specific DC Failure content.
	DCDCOverload or heat sink temperature too high	
	Abnormal cell acquisition or inconsistent aging levels	Please contact the after-sales service center.
	Fan operation not executed properly	Please contact the after-sales service center.
	Output port screw loose or poor contact	<ol style="list-style-type: none"> 1. Battery Shut down, check the wiring and output port screw status 2. After confirmation, restart the Battery and observe whether the fault persists. If it does, please contact the after-sales service center.
	Battery has been used for too long or the battery cell is severely damaged.	Please contact the after-sales service center to replace the pack.
	<p>The software version is too low or the BMS board is damaged.</p> <p>2. A large number of Inverter parallel units result in excessive impact during Battery pre-charging.</p>	<p>Upgrade the software and observe whether fault persists.</p> <p>2. In the case of parallel operation, perform a black start on Battery first, then start Inverter.</p>
	Heating film damaged	Please contact the after-sales service center.

fault name	fault cause	Troubleshooting recommendation
	The three-terminal fuse of the heating film is blown, rendering the heating function unusable.	Please contact the after-sales service center.
	Software model, Cell Type, and hardware model mismatch.	Check whether the software model, serial number (SN), Cell Type, and hardware model are consistent. If they are inconsistent, please contact the after-sales service center.
	Thermal management board communication disconnection	Let the system stand powered off for 5 minutes, then restart to check if fault persists. 2. If the fault is not restored, contact after-sales service to replace the pack.
	Thermal management board communication disconnection	Let the system stand powered off for 5 minutes, then restart and check if fault persists. 2. If the fault is not restored, contact after-sales service to replace the pack.

fault name	fault cause	Troubleshooting recommendation
	Thermal management board communication disconnection	<p>Let the system stand powered off for 5 minutes, then restart and check if fault persists.</p> <p>2. If the fault is not restored, contact after-sales service to replace the pack.</p>
	pack fan fault signal trigger	<p>Let the system stand powered off for 5 minutes, then restart and check if fault persists.</p> <p>2. If the fault is not restored, contact after-sales service to replace the pack.</p>
DC combiner box	Output portvoltage too high	<p>Check the output portvoltage. If the output portvoltage is normal and the fault still cannot be resolved after restarting Battery, please contact the after-sales service center.</p>

fault name	fault cause	Troubleshooting recommendation
	The DCDC module detected that the Battery Voltage exceeded the maximum Charge voltage.	Stop Charge and Discharge until SOC drops below 90% or remains idle for 2 hours. If the issue persists and restarting fault does not resolve it, please contact the after-sales service center.
	Radiator temperature too high	Let it stand for 1 hour until the radiator temperature decreases. If the issue persists and restarting the fault does not resolve it, please contact the after-sales service center.
	Battery discharge current is too large	Check if the load exceeds the Battery's Discharge capability. Turn off the load or stop the PCS for 60 seconds. If the issue persists after restarting fault, please contact the after-sales service center.
	Output port power harness positive and negative poles are reversed with the combiner box Battery or PCS.	Turn off the Battery manual switch, check if the output port wiring is correct, and restart the Battery.

fault name	fault cause	Troubleshooting recommendation
	The output Power relay cannot close.	Check whether the output port wiring is correct and if there is a short circuit. If the issue persists after restarting fault, please contact the after-sales service center.
	Power device temperature too high	Let the Battery stand for 1 hour to allow the internal Power components of the Battery to cool down. If the issue persists and restarting the fault does not resolve it, please contact the after-sales service center.
	Relay sticking	Restart fault still exists. Please contact the after-sales service center.
Battery Rack Circulating Current Failure	<ol style="list-style-type: none"> 1. Cell imbalance 2. First power on undercharge correction 	-

fault name	fault cause	Troubleshooting recommendation
BMS1 Other fault3 (Large Storage Category)	Communication exception with Linux module	<ol style="list-style-type: none"> 1. Check if the communication link is functioning properly. 2. Upgrade the software, restart the Battery, and observe whether the fault persists. If it does, please contact the after-sales service center.
	Excessive temperature rise of the battery cell	Abnormal battery cell, contact after-sales service to replace the pack.
	SOC below 10%	Perform Charge on Battery.
	SN writing does not comply with the rules	Check whether the SN digits are normal. If abnormal, please contact the after-sales service center.
	<ol style="list-style-type: none"> 1. Battery Intra-cluster daisy chain communication anomaly 2. Inconsistent aging levels of battery cells within Battery clusters 	<ol style="list-style-type: none"> 1. Check the contact condition of a single Battery pack. 2. Confirm the usage of each cluster Battery, such as cumulative charge Discharge capacity, number of cycles, etc. 3. Please contact the after-sales service center.

fault name	fault cause	Troubleshooting recommendation
	Excessive Humidity within the pack	-
	Fuse blown	Contact after-sales service to replace the pack.
	Low battery power	Perform Charge on Battery.
BMS1 Other fault4 (Large Storage Category)	Circuit breaker anomaly	Contact after-sales service to replace the pack.
	External device abnormality	Contact after-sales service to replace the pack.
Contactora Failure 1	-	-
Contactora Failure 2	-	-
Jinggui	Continuous Overload (over 690KVA) for 10s	Please contact the after-sales service center.
OverloadProtection(Smart port)	Continuous Overload (exceeding 690kVA) for 10s	Please contact the after-sales service center.
Master AC On Meter Comm Error	1. The meter may not be connected to the host. 2. Possible loose communication cable of the electric meter.	1. Check if the meter is connected to the main unit. 2. Check if the meter communication cable is loose.
Parallel Slave Meter Error	The meter is connected to the slave unit.	The meter connection machine is set as the master unit.

fault name	fault cause	Troubleshooting recommendation
Slave AC On Timeout with Master	<ol style="list-style-type: none"> 1. Incorrect slave address setting 2. Slave communication line is loose 	<ol style="list-style-type: none"> 1. Check if the slave address is duplicated. 2. Check if the parallel communication cable is loose.

11.5.2.2 Batteryfault

No.	fault name	fault cause	Troubleshooting recommendation
1	BMS1 Cluster 1 Total voltage Over WARNING /BMS1 RACK1 Total voltage is too high warning	<ol style="list-style-type: none"> 1. Battery systemvoltage too high 2. voltage collection line anomaly 	<ol style="list-style-type: none"> 1. Perform Discharge on Battery to check if fault persists. 2. If the fault is not restored, contact the after-sales service center.

No.	fault name	fault cause	Troubleshooting recommendation
2	BMS1 Cluster 1 Total voltage Too Low WARNING /BMS1 RACK1 Total voltage is too low warning	1. Battery systemvoltage too low 2. Abnormal voltage collection line	1. Perform Charge on the Battery, let it stand and observe whether the fault persists; 2. Determine the working condition of Inverter, check if it fails to supply Battery charge due to issues such as working mode, and attempt to supply Battery charge via Inverter, observing whether fault is restored. 3. If the fault is not restored, contact the after-sales service center.
3	BMS1 Cluster 1 Monomer voltage Overvoltage WARNING /BMS1 RACK1 Cell voltage is too high warning	1. The voltage of a single cell is too high. 2. voltage Acquisition Line Anomaly	1. Perform Discharge on Battery, and observe whether fault persists after standing. 2. If the fault is not restored, contact the after-sales service center.

No.	fault name	fault cause	Troubleshooting recommendation
4	BMS1 Cluster 1 Cell voltage Undervoltage WARNING /BMS1 RACK1 Cell voltage is too low warning	1. Single cell voltage too low 2. Abnormal voltage collection line	1. Perform Charge on the Battery, and observe whether the fault persists after standing; 2. Determine the working condition of Inverter, check if Battery charge is not being supplied due to issues such as working mode, and attempt to supply Battery charge via Inverter to observe if fault is restored. 3. If the fault is not restored, contact after-sales service.
5	BMS1 Cluster 1 Charge Over Temperature WARNING /BMS1 RACK1 Charging temperature is too high warning	1. Ambient Overtemperature 2. Temperature sensor abnormality	1. Stop charging and observe whether the fault persists during static conditions; 2. If the fault is not restored, contact the after-sales service center.

No.	fault name	fault cause	Troubleshooting recommendation
6	BMS1 Cluster 1 Discharge Over Temperature WARNING /BMS1 RACK1 Discharging temperature is too high warning	<ol style="list-style-type: none"> 1. Ambient Overtemperature 2. Temperature sensor abnormality 	<ol style="list-style-type: none"> 1. Stop charging and observe whether the fault persists during the resting period; 2. If the fault is not restored, contact after-sales service.
7	BMS1 Cluster 1 Charge Temperature Too Low WARNING /BMS1 RACK1 Charging temperature is too low warning	<ol style="list-style-type: none"> 1. Ambient temperature is too low 2. Temperature sensor abnormality 	<ol style="list-style-type: none"> 1. Check the cell temperature in the background. If the minimum temperature is above -20°C, set Battery discharge to increase the cell temperature. 2. If the temperature is below -20°C, shut down the Battery and place it in a warm environment. Use it only after the battery cell temperature has recovered. 3. If none of the above works, contact the after-sales service center.

No.	fault name	fault cause	Troubleshooting recommendation
8	BMS1 Cluster 1 Discharge Temperature Too Low WARNING/ BMS1 RACK1 Discharging temperature is too low warning	1. Ambient temperature is too low 2. Temperature sensor abnormality	1. Check the cell temperature in the background. If the minimum temperature is higher than -20°C, set Battery discharge to increase the cell temperature. 2. If the temperature is below -20°C, shut down the Battery and place it in a warm environment. Use it only after the battery cell temperature has recovered. 3. If none of the above works, contact the after-sales service center.
9	BMS1 Cluster 1 Overcurrent BMS1 RACK1 Charge overcurrent warning	1.Excessive Charging Current, abnormal Battery current limiting: Sudden changes in temperature and voltage values 2. Abnormal Inverter response	1. Stop Charge and observe whether fault persists; 2. Check whether the Inverter is set with an excessively large Power, causing it to exceed the rated operating current of the Battery; 3. If continuous overcurrent occurs, contact the after-sales service center.

No.	fault name	fault cause	Troubleshooting recommendation
10	BMS1 Cluster 1 Overcurrent BMS1 RACK1 Discharge overcurrent warning	1. Discharge current is too large, Battery current limiting is abnormal: temperature and voltage value suddenly change 2. Abnormal Inverter response	1. Stop Discharge and observe if fault persists; 2. Check if the Inverter is set with an excessively large Power, causing it to exceed the rated working current of the Battery; 3. If continuous overcurrent occurs, contact the after-sales service center.
11	BMS1 Cluster 1 Insulation Resistance Low WARNING/ BMS1 RACK1 Insulation resistance is too low warning	Insulation resistance failure or abnormal contact	Check if the ground wire is properly connected and restart the Battery. If the issue persists after restarting, please contact the after-sales service center.

No.	fault name	fault cause	Troubleshooting recommendation
12	BMS1 Cluster 1 Single Cell Temperature Difference Exceeds LimitWARNING/ BMS1 RACK1 Cell excessive temperature differentials warning	<ol style="list-style-type: none"> 1. Excessive temperature difference at different stages. Battery will impose restrictions on BatteryPower, i.e., limit the charging of Dischargecurrent. Therefore, this issue is generally unlikely to occur. 2. The capacity of the battery cell degrades, leading to excessive internal resistance, resulting in significant temperature rise and large temperature differences during Overcurrent. 3. Poor welding of battery cell tabs, leading to excessive temperature rise in the Overcurrent cell. 4. Temperature sampling issue; 5. Loose power cable connection 	Shut down, restart Battery, and wait for 2 hours. If the issue persists, contact the after-sales service center.

No.	fault name	fault cause	Troubleshooting recommendation
13	BMS1 Cluster 1 Pole Temperature Too HighWARNING/ BMS1 RACK1 Post temperature is too high warning	Pole temperature too high	1. Stop charging Discharge, and observe whether fault persists during the resting period; 2. If the fault is not restored, contact the after-sales service center.
14	BMS1 Cluster 1 Excessive Cell Voltage DeviationWARNING/ BMS1 RACK1 Cell excessive voltage differentials warning	1.Inconsistent aging levels of battery cells 2. Issues with the board chip can also lead to excessive voltage differences between battery cells. 3. Imbalance issues in the battery pack can also lead to excessive voltage differences between cells. 4. Wiring harness issues causing	1. Stop charging Discharge, and observe whether fault persists during the resting period; 2. If the fault is not restored, contact the after-sales service center.
15	BMS1 Cluster 1PCS Comm LossWARNING/ BMS1 RACK1 PCS communication loss warning	Abnormal communication between BMS and PCS	Check whether the communication line between Battery and Inverter is properly connected.
16	BMS1 Cluster 1 DCDCWARNING/ BMS1 RACK1 DCDC warning	There is an internal voltage or current abnormality in the DCDC.	Upgrade the software and restart the Battery. If the issue persists after restarting, please contact the after-sales service center.

No.	fault name	fault cause	Troubleshooting recommendation
17	BMS1 Cluster 1 Heating Film MOS Adhesion WARNING BMS1 RACK1 Heat film MOS adhesion warning	Heating film MOS damage	Please contact the after-sales service center.
18	BMS1 Cluster 1 Heating Film MOS Open Circuit WARNING BMS1 RACK1 Heat film MOS open warning	Heating circuit abnormality	Please contact the after-sales service center.
19	BMS1 Cluster 1 Total voltage Over fault BMS1 RACK1 Total voltage is too high fault	1. Battery systemvoltage too high 2. Abnormal voltage collection line	1. Perform Discharge on Battery to check if fault persists. 2. If the fault is not restored, please contact the after-sales service center.
20	BMS1 Cluster 1 Total voltage Low fault/ BMS1 RACK1 Total voltage is too low fault	1. Battery systemvoltage too low 2. Abnormal voltage collection line	1. Perform Charge on the Battery, and observe whether the fault persists after standing; 2. Determine the working condition of Inverter, check if it fails to supply Battery charge due to issues such as working mode, and attempt to supply Battery charge via Inverter, observing whether fault is restored. 3. If the fault is not restored, please contact the after-sales service center.

No.	fault name	fault cause	Troubleshooting recommendation
21	BMS1 Cluster 1 Cell voltage Overvoltage fault/ BMS1 RACK1 Cell voltage is too high fault	1. The voltage of a single cell is too high. 2. Abnormal voltage collection line	1. Perform Discharge on Battery, and observe whether fault persists after standing. 2. If the fault is not restored, please contact the after-sales service center.
22	BMS1 Cluster 1 Cell voltage Undervoltage fault/ BMS1 RACK1 Cell voltage is too low fault	1. Single cell voltage too low 2. Abnormal voltage collection line	1. Perform Charge on the Battery, and observe whether the fault persists after standing; 2. Determine the working condition of Inverter, check if it fails to supply Battery charge due to issues such as working mode, and attempt to supply Battery charge via Inverter, observing whether fault is restored. 3. If the fault is not restored, please contact the after-sales service center.
23	BMS1 Cluster 1 Charge Temperature Overlimit fault/ BMS1 RACK1 Charging temperature is too high fault	1. Ambient Overtemperature 2. Temperature sensor abnormality	1. Place the Battery in a cool place, let it shut down and rest for 30 minutes, then restart it to see if the fault persists; 2. If the fault persists, please contact the after-sales service center.

No.	fault name	fault cause	Troubleshooting recommendation
24	BMS1 Cluster 1 Discharge Temperature Too High fault/ BMS1 RACK1 Discharging temperature is too high fault	1. Ambient Overtemperature 2. Temperature sensor abnormality	1. Place the Battery in a cool place, let it shut down and remain idle for 30 minutes, then restart it to check if the fault persists; 2. If the fault persists, please contact the after-sales service center.
25	BMS1 Cluster 1 Charge Temperature Too Low fault/ BMS1 RACK1 Charging temperature is too low fault	1. Ambient temperature is too low 2. Temperature sensor abnormality	1. Check the cell temperature in the background. If the minimum temperature is higher than -20°C, set Battery discharge to increase the cell temperature. 2. If the temperature is below -20°C, shut down the Battery and place it in a warm environment. Use it only after the battery cell temperature has recovered. 3. If none of the above works, contact the after-sales service center.

No.	fault name	fault cause	Troubleshooting recommendation
26	BMS1 Cluster 1 Discharge Temperature Too Low fault BMS1 RACK1 Discharging temperature is too low fault	1. Ambient temperature is too low 2. Temperature sensor abnormality	1. Check the cell temperature in the background. If the minimum temperature is higher than -20°C, set Battery discharge to increase the cell temperature. 2. If the temperature is below -20°C, shut down the Battery and place it in a warm environment. Use it only after the battery cell temperature has recovered. 3. If none of the above works, contact the after-sales service center.
27	BMS1 Cluster 1 Charge Overcurrent fault/ BMS1 RACK1 Charge overcurrent fault	1.Excessive Charging Current, abnormal Battery current limiting: Sudden changes in temperature and voltage values 2. Abnormal Inverter response	1. Let the system remain powered off for 5 minutes, then restart and check if fault persists; 2. Check if the Inverter is set with an excessively large Power, causing it to exceed the rated working current of the Battery; 3. If continuous overcurrent occurs, contact the after-sales service center.

No.	fault name	fault cause	Troubleshooting recommendation
28	BMS1 Cluster 1 Overcurrent BMS1 RACK1 Discharge overcurrent fault	1. Discharge current is too large, Battery current limiting is abnormal: temperature and voltage value suddenly change 2. Abnormal Inverter response	1. Let the system remain powered off for 5 minutes, then restart and check if fault persists; 2. Check if the Inverter is set with an excessively large Power, causing it to exceed the rated working current of the Battery; 3. If continuous overcurrent occurs, contact the after-sales service center.
29	BMS1 Cluster 1 Insulation Resistance Low fault/ BMS1 RACK1 Insulation resistance is too low fault	Insulation resistance failure or abnormal contact	1. Check if the ground wire is properly connected and restart the Battery, 2. Upgrade the software. If the issue persists, please contact the after-sales service center.

No.	fault name	fault cause	Troubleshooting recommendation
30	BMS1 Cluster 1 Single Cell Temperature Difference Exceeds Limit fault/ BMS1 RACK1 Cell excessive temperature differentials fault	<ol style="list-style-type: none"> 1. Excessive temperature difference at different stages. Battery will impose restrictions on BatteryPower, i.e., limit the charging of Dischargecurrent. Therefore, this issue is generally unlikely to occur. 2. The capacity of the battery cell degrades, leading to excessive internal resistance, resulting in significant temperature rise and large temperature differences during Overcurrent. 3. Poor welding of battery cell tabs, leading to excessive temperature rise in the Overcurrent cell. 4. Temperature sampling issue; 5. Loose power cable connection 	Shut down, restart Battery, and wait for 2 hours. If the issue persists, contact the after-sales service center.

No.	fault name	fault cause	Troubleshooting recommendation
31	BMS1 Cluster 1 Pole Temperature Too Highfault/ BMS1 RACK1 Post temperature is too high fault	Pole temperature too high	<ol style="list-style-type: none"> 1. Power off and let it stand for 30 minutes, then restart to check if fault persists; 2. If the fault persists, please contact the after-sales service center.
32	BMS1 Cluster 1 Excessive Cell Voltage Difference fault/ BMS1 RACK1 Cell excessive voltage differentials fault	<ol style="list-style-type: none"> 1. Inconsistent aging levels of battery cells 2. Issues with the board chip can also lead to excessive voltage differences between battery cells. 3. Imbalance issues in the battery pack can also lead to excessive voltage differences between cells. 4. Wiring harness issue causing 	Shut down, restart Battery, and wait for 2 hours. If the issue persists, contact the after-sales service center.
33	BMS1 Cluster 1 Relay or MOS Short Circuit fault BMS1 RACK1 Relay or MOS short-circuit fault	MOS short circuit	<ol style="list-style-type: none"> 1. Upgrade the software, power off and let it sit for 5 minutes, then check if fault persists after restarting. 2. If the issue persists, contact the after-sales service center.

No.	fault name	fault cause	Troubleshooting recommendation
34	BMS1 Cluster 1 relay or MOS open circuit fault/ BMS1 RACK1 Relay or MOS open-circuit fault	MOS open circuit	<ol style="list-style-type: none"> 1. Upgrade the software, power off and let it sit for 5 minutes, then check if fault persists after restarting. 2. If the issue persists, contact the after-sales service center.
35	BMS1 Cluster 1Pre-charging Failurefault/ BMS1 RACK1 The precharge failed fault	The voltage across the precharge MOS voltage consistently exceeds the specified threshold.	<ol style="list-style-type: none"> 1. Upgrade the software, power off and let it sit for 5 minutes, then check if fault persists after restarting. 2. If the issue persists, contact the after-sales service center.
36	BMS1 Cluster 1 Acquisition Line fault BMS1 RACK1 Acquisition line fault	Collection line Battery is disconnected or broken	Power off, check the wiring, re-stack the Battery, and restart. If the issue persists, please contact the after-sales service center.

No.	fault name	fault cause	Troubleshooting recommendation
37	BMS1 Cluster 1 Relay or MOS Over Temperature fault BMS1 RACK1 Relay or MOS temperature is too high fault	Relay or MOSFET overtemperature	<ol style="list-style-type: none"> 1. Upgrade the software, power off and let it sit for 30 minutes, then check if fault persists after restarting. 2. If the issue persists, contact the after-sales service center.
38	BMS1 Cluster 1 Shunt Over-temperaturefault/ BMS1 RACK1 Diverter temperature is too high fault	Shunt Over-temperature	<ol style="list-style-type: none"> 1. Upgrade the software, power off and let it sit for 30 minutes, then check if fault persists after restarting. 2. If the issue persists, contact the after-sales service center.
39	BMS1 Cluster 1 Communication from MCU fault BMS1 RACK1 Slave MCU communication fault	Communication loss between master and slave chips	<ol style="list-style-type: none"> 1. Check the wiring and restart the Battery. 2. Upgrade the Battery. If the problem persists after restarting, please contact the after-sales service center.
40	BMS1 Cluster 1 BMU Communication fault BMS1 RACK1 BMU communication fault	Abnormal communication harness between BMS master and slave control	<ol style="list-style-type: none"> 1. Check the wiring and restart the Battery. 2. Upgrade the Battery. If the issue persists after restarting, please contact the after-sales service center.

No.	fault name	fault cause	Troubleshooting recommendation
41	BMS1 Cluster 1 Microelectronics fault BMS1 RACK1 Micro- electronics fault	Internal fault of MCU	Upgrade the software and restart the Battery. If the issue persists after restarting, please contact the after-sales service center.
42	BMS1 Cluster 1Hardware Overcurrentfault/ BMS1 RACK1 Hardware overcurrent fault	1. The software version is too low or the BMS board is damaged. 2. The number of Inverter parallel units is large, and the Battery experiences excessive impact during pre-charging.	1. Upgrade the software and observe whether fault persists. 2. In the case of parallel operation, perform a black start on Battery before starting Inverter.
43	BMS1 Cluster 1 Application Software Failure/ BMS1 RACK1 Application software fault	MCU self-test failed	Upgrade the software and restart the Battery. If the issue persists after restarting, please contact the after-sales service center.
44	BMS1 Cluster 1 Cluster fault/ BMS1 RACK1 Parallel RACK fault	Communication abnormality between the master cluster and slave cluster, or inconsistency of battery cells between clusters.	1. Check the Battery information and software version of the slave unit, as well as whether the communication line connection with the master unit is normal. 2. Upgrade the software

No.	fault name	fault cause	Troubleshooting recommendation
45	BMS1 Cluster 1 DCDC Failure/ BMS1 RACK1 DCDC fault	DCDCOverload or heat sink temperature too high	Upgrade the software and restart the Battery. If the issue persists after restarting, please contact the after-sales service center.
46	BMS1 Cluster 1 Cell Inconsistencyfault BMS1 RACK1 Inconsistent cell fault	1. Abnormal cell identification 2. Stacking of Different Types of Battery Cells	Check Cell Type
47	BMS1 Cluster 1 Output port Overtemperature fault/ BMS1 RACK1 The output port over temperature fault	Output port screw loose or poor contact	1. Battery shutdown, check wiring and output port screw status 2. After confirmation, restart the Battery and observe whether the fault persists. If it does, contact the after-sales service center.
48	BMS1 Cluster 1 SOH Too Lowfault/ BMS1 RACK1 SOH too low fault	Battery has been used for too long or the battery cell is severely damaged.	Replace the pack
49	BMS1 Cluster 1 Heating Film Three-Terminal fault BMS1 RACK1 Heating film MOS Three-terminal fault	Heating film MOS damage	Please contact the after-sales service center.

11.5.3 Operation After Fault Clearance

In the energy conservation system, after some fault clearances complete, further operations are needed for the system to restore normal work.

11.5.3.1 Clear AFCI Alarm

[Software]: SolarGo App

[Clearance method]:

1. Step 1: Go to the settings page via **Home > Settings > Advanced Settings > DC AFCI** to set up the AFCI detection function.
2. Tap **[Clear AFCI Alarm]**.

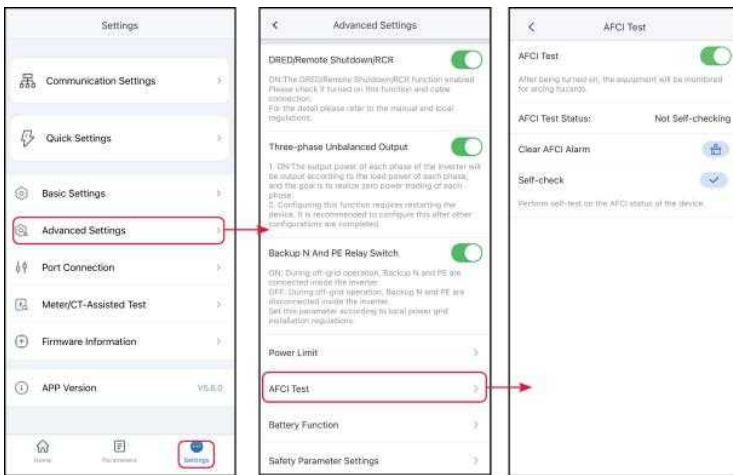

12 Technical Parameters

12.1 Inverter Parameters

Technical Data	GW3K-EHA-G20	GW3.6K-EHA-G20	GW5K-EHA-G20	GW6K-EHA-G20
Battery Side				
Battery Type	Li-ion	Li-ion	Li-ion	Li-ion
Nominal Battery Voltage (V)	380	380	380	380
Battery Voltage Range (V)	350~550	350~550	350~550	350~550
Start-up Voltage (V)*1	380	380	380	380
Number of Battery Input	1	1	1	1
Max. Continuous Charging Current (A)	11.9	14.3	19.8	23.7
Max. Continuous Discharging Current (A)	8.7	10.5	14.5	17.4
Max. Charging Power (kW)	4.5	5.4	7.5	9

Technical Data	GW3K-EHA-G20	GW3.6K-EHA-G20	GW5K-EHA-G20	GW6K-EHA-G20
Max. Discharging Power (kW)	3.3	3.96	5.5	6.6
PV Side				
Max. Input Power (kW)	6	7.2	10	12
Max. Input Voltage (V)*2	600	600	600	600
MPPT Operating Voltage Range (V)*3	40~560	40~560	40~560	40~560
MPPT Voltage Range at Nominal Power (V)	150~500	150~500	170~500	210~500
Start-up Voltage (V)	50	50	50	50
Nominal Input Voltage (V)	400	400	400	400
Max. MPPT Current (A)	20	20	20	20
Max. MPPT Short Circuit Current (A)	26	26	26	26
Max. Backfeed Current to The Array (A)	0	0	0	0

Technical Data	GW3K-EHA-G20	GW3.6K-EHA-G20	GW5K-EHA-G20	GW6K-EHA-G20
Number of MPPTs	2	2	2	2
Number of Strings per MPPT	1/1	1/1	1/1	1/1
AC Side (On-grid)				
Nominal Power (kW)	3	3.6	5	6
Nominal Apparent Power to Grid (kVA)	3	3.6	5	6
Max. Apparent Power to Grid (kVA)	3	3.6	5	6
Nominal Apparent Power from Grid (kVA)	3	3.6	5	6
Max. Apparent Power from Grid (kVA)*5	6	7.2	10	12
Nominal Voltage (V)	220/230/240, L/N/PE	220/230/240, L/N/PE	220/230/240, L/N/PE	220/230/240, L/N/PE
Voltage Range (V)	170~280	170~280	170~280	170~280
Nominal Frequency (Hz)	50/60	50/60	50/60	50/60

Technical Data	GW3K-EHA-G20	GW3.6K-EHA-G20	GW5K-EHA-G20	GW6K-EHA-G20
Frequency Range (Hz)	45~55 / 55~65	45~55 / 55~65	45~55 / 55~65	45~55 / 55~65
Max. Current to Grid (A)	13.7 at 220V 13.1 at 230V 12.5 at 240V	16.4 at 220V 15.7 at 230V 15 at 240V	22.8 at 220V 21.8 at 230V 20.9 at 240V	27.3 at 220V 26.1 at 230V 25 at 240V
Max. Current From Grid (A) ^{*5}	27.3 at 220V 26.1 at 230V 25 at 240V	32.8 at 220V 31.4 at 230V 30 at 240V	45.5 at 220V 43.5 at 230V 41.7 at 240V	50 at 220V 50 at 230V 50 at 240V
Nominal Current From Grid (A)	13.7 at 220V 13.1 at 230V 12.5 at 240V	16.4 at 220V 15.7 at 230V 15 at 240V	22.8 at 220V 21.8 at 230V 20.9 at 240V	27.3 at 220V 26.1 at 230V 25 at 240V
Max. Output Fault Current (Peak and Duration) (A)	96 at 3μs	96 at 3μs	96 at 3μs	96 at 3μs
Inrush Current (Peak and Duration) (A)	96 at 3μs	96 at 3μs	96 at 3μs	96 at 3μs
Nominal Current (A)	13.7 at 220V 13.1 at 230V 12.5 at 240V	16.4 at 220V 15.7 at 230V 15 at 240V	22.8 at 220V 21.8 at 230V 20.9 at 240V	27.3 at 220V 26.1 at 230V 25 at 240V

Technical Data	GW3K-EHA-G20	GW3.6K-EHA-G20	GW5K-EHA-G20	GW6K-EHA-G20
Power Factor	~1 (Adjustable from 0.8 leading to 0.8 lagging)	~1 (Adjustable from 0.8 leading to 0.8 lagging)	~1 (Adjustable from 0.8 leading to 0.8 lagging)	~1 (Adjustable from 0.8 leading to 0.8 lagging)
THDi	<3%	<3%	<3%	<3%
Maximum Output Overcurrent Protection (A)	96	96	96	96
Type of Voltage	a.c.	a.c.	a.c.	a.c.
Back-up Side				
Nominal Output Apparent Power (kVA)	3	3.6	5	6
Max. Output Apparent Power (kVA)	3.0 (6.0, 10s)	3.6 (7.2, 10s)	5.0 (10.0, 10s)	6.0(12.0, 10s)
Max. Output Apparent Power (Bypass) (kVA)	6	7.2	10	12
Nominal Output Current (A)	13.7 at 220V 13.1 at 230V 12.5 at 240V	16.4 at 220V 15.7 at 230V 15 at 240V	22.8 at 220V 21.8 at 230V 20.9 at 240V	27.3 at 220V 26.1 at 230V 25 at 240V

Technical Data	GW3K-EHA-G20	GW3.6K-EHA-G20	GW5K-EHA-G20	GW6K-EHA-G20
Max. Output Current (A) ^{*4}	13.7 at 220V 13.1 at 230V 12.5 at 240V	16.4 at 220V 15.7 at 230V 15 at 240V	22.8 at 220V 21.8 at 230V 20.9 at 240V	27.3 at 220V 26.1 at 230V 25 at 240V
Max. Output Current (Bypass) (A) ^{*4}	27.3	32.8	45.5	50
Max. Fault Current (Peak and Duration) (A)	96 at 3μs	96 at 3μs	96 at 3μs	96 at 3μs
Inrush Current (Peak and Duration) (A)	96 at 3μs	96 at 3μs	96 at 3μs	96 at 3μs
Max. Output Overcurrent Protection (A)	96	96	96	96
Nominal Output Voltage (V)	220/230/240, L/N/PE	220/230/240, L/N/PE	220/230/240, L/N/PE	220/230/240, L/N/PE
Nominal Output Frequency (Hz)	50/60	50/60	50/60	50/60
THDv (@Linear Load)	<3%	<3%	<3%	<3%
Efficiency				
Max. Efficiency	97.60%	97.60%	97.60%	97.60%

Technical Data	GW3K-EHA-G20	GW3.6K-EHA-G20	GW5K-EHA-G20	GW6K-EHA-G20
European Efficiency	96.50%	96.50%	96.80%	97.00%
Max. Battery to AC Efficiency	98.00%	98.00%	98.00%	98.00%
Protection				
PV String Current Monitoring	Integrated	Integrated	Integrated	Integrated
PV Insulation Resistance Detection	Integrated	Integrated	Integrated	Integrated
Residual Current Monitoring	Integrated	Integrated	Integrated	Integrated
PV Reverse Polarity Protection	Integrated	Integrated	Integrated	Integrated
Battery Reverse Polarity Protection	Integrated	Integrated	Integrated	Integrated
Anti-islanding Protection	Integrated	Integrated	Integrated	Integrated
AC Overcurrent Protection	Integrated	Integrated	Integrated	Integrated
AC Short Circuit Protection	Integrated	Integrated	Integrated	Integrated

Technical Data	GW3K-EHA-G20	GW3.6K-EHA-G20	GW5K-EHA-G20	GW6K-EHA-G20
AC Overvoltage Protection	Integrated	Integrated	Integrated	Integrated
DC Surge Protection	Type II	Type II	Type II	Type II
AC Surge Protection	Type II	Type II	Type II	Type II
RSD	Optional	Optional	Optional	Optional
AFCI	Integrated	Integrated	Integrated	Integrated
Remote Shutdown	Integrated	Integrated	Integrated	Integrated
General Data				
Operating Temperature Range (°C)	-35~+60 (Derating at +40)	-35~+60 (Derating at +40)	-35~+60 (Derating at +40)	-35~+60 (Derating at +40)
Operating Environment	Outdoor	Outdoor	Outdoor	Outdoor
Relative Humidity	0~95%	0~95%	0~95%	0~95%
Max. Operating Altitude (m)	4000 (>2000 derating)	4000 (>2000 derating)	4000 (>2000 derating)	4000 (>2000 derating)
Cooling Method	Natural convection	Natural convection	Natural convection	Natural convection
User Interface	LED, WLAN+APP	LED, WLAN+APP	LED, WLAN+APP	LED, WLAN+APP

Technical Data	GW3K-EHA-G20	GW3.6K-EHA-G20	GW5K-EHA-G20	GW6K-EHA-G20
Communication with BMS	CAN	CAN	CAN	CAN
Communication	RS485, WiFi+LAN+Bluetooth	RS485, WiFi+LAN+Bluetooth	RS485, WiFi+LAN+Bluetooth	RS485, WiFi+LAN+Bluetooth
Communication Protocols	Modbus-RTU, Modbus-TCP	Modbus-RTU, Modbus-TCP	Modbus-RTU, Modbus-TCP	Modbus-RTU, Modbus-TCP
Weight (kg)	24	24	24	24
Dimension (W×H×D mm)	800*300*270	800*300*270	800*300*270	800*300*270
Noise Emission (dB)	≤30	≤30	≤30	≤30
Topology	Non-isolated	Non-isolated	Non-isolated	Non-isolated
Power Self-consumption at Night (W)	≤10	≤10	≤10	≤10
Ingress Protection Rating	IP66	IP66	IP66	IP66
DC Connector	MC4	MC4	MC4	MC4
AC Connector	plug & play terminal	plug & play terminal	plug & play terminal	plug & play terminal
Environmental Category	4K4H	4K4H	4K4H	4K4H

Technical Data	GW3K-EHA-G20	GW3.6K-EHA-G20	GW5K-EHA-G20	GW6K-EHA-G20
Pollution Degree	III (Outside of the inverter)	III (Outside of the inverter)	III (Outside of the inverter)	III (Outside of the inverter)
Overvoltage Category	DC II / AC III	DC II / AC III	DC II / AC III	DC II / AC III
Protective Class	I	I	I	I
Storage Temperature (°C)	-40~+70	-40~+70	-40~+70	-40~+70
Decisive Voltage Class (DVC)	Battery: A PV: C AC: C Com: A	Battery: A PV: C AC: C Com: A	Battery: A PV: C AC: C Com: A	Battery: A PV: C AC: C Com: A
Mounting Method	Wall/Floor Mounted	Wall/Floor Mounted	Wall/Floor Mounted	Wall/Floor Mounted
Active Anti-islanding Method	SMS(Slip-mode frequency) +AFD	SMS(Slip-mode frequency) +AFD	SMS(Slip-mode frequency) +AFD	SMS(Slip-mode frequency) +AFD
Country of Manufacture	China	China	China	China
Certification				
Grid Standard	IEC/EN 61000-6-1/-2/-3/-4, IEC/EN 62920, CISPR 11, EN 55011, AS/NZS 61000.6.3/.4, AS 61000.6.4			
Safety Regulation	IEC62109-1/-2, IEC 63037			
EMC	IEC/EN 61000-6-1/-2/-3/-4			

Technical Data	GW8K-EHA-G20	GW9.999K-EHA-G20	GW10K-EHA-G20
Battery Side			
Battery Type	Li-ion	Li-ion	Li-ion
Nominal Battery Voltage (V)	380	380	380
Battery Voltage Range (V)	350~550	350~550	350~550
Start-up Voltage (V) ^{*1}	380	380	380
Number of Battery Input	1	1	1
Max. Continuous Charging Current (A)	31.6	35.6	35.6
Max. Continuous Discharging Current (A)	23.2	29	29
Max. Charging Power (kW)	12	13.5	13.5
Max. Discharging Power (kW)	8.8	11	11
PV Side			
Max. Input Power (kW)	16	20	20
Max. Input Voltage (V) ^{*2}	600	600	600

Technical Data	GW8K-EHA-G20	GW9.999K-EHA-G20	GW10K-EHA-G20
MPPT Operating Voltage Range (V) ^{*3}	40~560	40~560	40~560
MPPT Voltage Range at Nominal Power (V)	170~500	190~500	190~500
Start-up Voltage (V)	50	50	50
Nominal Input Voltage (V)	400	400	400
Max. MPPT Current (A)	20	20	20
Max. MPPT Short Circuit Current (A)	26	26	26
Max. Backfeed Current to The Array (A)	0	0	0
Number of MPPTs	4	4	4
Number of Strings per MPPT	1/1/1/1	1/1/1/1	1/1/1/1
AC Side (On-grid)			
Nominal Power (kW)	8	9.999	10
Nominal Apparent Power to Grid (kVA)	8	9.999	10
Max. Apparent Power to Grid (kVA)	8	9.999	10

Technical Data	GW8K-EHA-G20	GW9.999K-EHA-G20	GW10K-EHA-G20
Nominal Apparent Power from Grid (kVA)	8	9.999	10
Max. Apparent Power from Grid (kVA) ^{*5}	14.5	14.5	14.5
Nominal Voltage (V)	220/230/240, L/N/PE	220/230/240, L/N/PE	220/230/240, L/N/PE
Voltage Range (V)	170~280	170~280	170~280
Nominal Frequency (Hz)	50/60	50/60	50/60
Frequency Range (Hz)	45~55 / 55~65	45~55 / 55~65	45~55 / 55~65
Max. Current to Grid (A)	36.4 at 220V 34.8 at 230V 33.4 at 240V	43.5 at 220V 43.5 at 230V 41.7 at 240V	43.5 at 220V 43.5 at 230V 41.7 at 240V
Max. Current From Grid (A) ^{*5}	63 at 220V 63 at 230V 60.5 at 240V	63 at 220V 63 at 230V 60.5 at 240V	63 at 220V 63 at 230V 60.5 at 240V
Nominal Current From Grid (A)	36.4 at 220V 34.8 at 230V 33.4 at 240V	45.5 at 220V 43.5 at 230V 41.7 at 240V	45.5 at 220V 43.5 at 230V 41.7 at 240V

Technical Data	GW8K-EHA-G20	GW9.999K-EHA-G20	GW10K-EHA-G20
Max. Output Fault Current (Peak and Duration) (A)	120 at 3 μ s	120 at 3 μ s	120 at 3 μ s
Inrush Current (Peak and Duration) (A)	120 at 3 μ s	120 at 3 μ s	120 at 3 μ s
Nominal Current (A)	36.4 at 220V 34.8 at 230V 33.4 at 240V	43.5 at 220V 43.5 at 230V 41.7 at 240V	43.5 at 220V 43.5 at 230V 41.7 at 240V
Power Factor	~1 (Adjustable from 0.8 leading to 0.8 lagging)	~1 (Adjustable from 0.8 leading to 0.8 lagging)	~1 (Adjustable from 0.8 leading to 0.8 lagging)
THDi	<3%	<3%	<3%
Maximum Output Overcurrent Protection (A)	120	120	120
Type of Voltage	a.c.	a.c.	a.c.
Back-up Side			
Nominal Output Apparent Power (kVA)	8	10	10
Max. Output Apparent Power (kVA)	8.0(16.0, 10s)	10.0(20.0, 10s)	10.0(20.0, 10s)

Technical Data	GW8K-EHA-G20	GW9.999K-EHA-G20	GW10K-EHA-G20
Max. Output Apparent Power (Bypass) (kVA)	14.5	14.5	14.5
Nominal Output Current (A)	36.4 at 220V 34.8 at 230V 33.4 at 240V	43.5 at 220V 43.5 at 230V 41.7 at 240V	43.5 at 220V 43.5 at 230V 41.7 at 240V
Max. Output Current (A) ^{*4}	36.4 at 220V 34.8 at 230V 33.4 at 240V	43.5 at 220V 43.5 at 230V 41.7 at 240V	43.5 at 220V 43.5 at 230V 41.7 at 240V
Max. Output Current (Bypass) (A) ^{*4}	63	63	63
Max. Fault Current (Peak and Duration) (A)	120 at 3μs	120 at 3μs	120 at 3μs
Inrush Current (Peak and Duration) (A)	120 at 3μs	120 at 3μs	120 at 3μs
Max. Output Overcurrent Protection (A)	120	120	120
Nominal Output Voltage (V)	220/230/240, L/N/PE	220/230/240, L/N/PE	220/230/240, L/N/PE
Nominal Output Frequency (Hz)	50/60	50/60	50/60

Technical Data	GW8K-EHA-G20	GW9.999K-EHA-G20	GW10K-EHA-G20
THDv (@Linear Load)	<3%	<3%	<3%
Efficiency			
Max. Efficiency	97.50%	97.50%	97.50%
European Efficiency	96.80%	96.80%	96.80%
Max. Battery to AC Efficiency	97.80%	97.80%	97.80%
Protection			
PV String Current Monitoring	Integrated	Integrated	Integrated
PV Insulation Resistance Detection	Integrated	Integrated	Integrated
Residual Current Monitoring	Integrated	Integrated	Integrated
PV Reverse Polarity Protection	Integrated	Integrated	Integrated
Battery Reverse Polarity Protection	Integrated	Integrated	Integrated
Anti-islanding Protection	Integrated	Integrated	Integrated
AC Overcurrent Protection	Integrated	Integrated	Integrated
AC Short Circuit Protection	Integrated	Integrated	Integrated

Technical Data	GW8K-EHA-G20	GW9.999K-EHA-G20	GW10K-EHA-G20
AC Overvoltage Protection	Integrated	Integrated	Integrated
DC Surge Protection	Type II	Type II	Type II
AC Surge Protection	Type II	Type II	Type II
RSD	Optional	Optional	Optional
AFCI	Integrated	Integrated	Integrated
Remote Shutdown	Integrated	Integrated	Integrated
General Data			
Operating Temperature Range (°C)	-35~+60 (Derating at +40)	-35~+60 (Derating at +40)	-35~+60 (Derating at +40)
Operating Environment	Outdoor	Outdoor	Outdoor
Relative Humidity	0~95%	0~95%	0~95%
Max. Operating Altitude (m)	4000 (>2000 derating)	4000 (>2000 derating)	4000 (>2000 derating)
Cooling Method	Natural convection	Natural convection	Natural convection
User Interface	LED, WLAN+APP	LED, WLAN+APP	LED, WLAN+APP
Communication with BMS	CAN	CAN	CAN
Communication	RS485, WiFi+LAN+Bluetooth	RS485, WiFi+LAN+Bluetooth	RS485, WiFi+LAN+Bluetooth

Technical Data	GW8K-EHA-G20	GW9.999K-EHA-G20	GW10K-EHA-G20
Communication Protocols	Modbus-RTU, Modbus-TCP	Modbus-RTU, Modbus-TCP	Modbus-RTU, Modbus-TCP
Weight (kg)	26	26	26
Dimension (W×H×D mm)	800*300*270	800*300*270	800*300*270
Noise Emission (dB)	≤35	≤35	≤35
Topology	Non-isolated	Non-isolated	Non-isolated
Power Self-consumption at Night (W)	≤10	≤10	≤10
Ingress Protection Rating	IP66	IP66	IP66
DC Connector	MC4	MC4	MC4
AC Connector	plug & play terminal	plug & play terminal	plug & play terminal
Environmental Category	4K4H	4K4H	4K4H
Pollution Degree	III (Outside of the inverter)	III (Outside of the inverter)	III (Outside of the inverter)
Overvoltage Category	DC II / AC III	DC II / AC III	DC II / AC III
Protective Class	I	I	I

Technical Data	GW8K-EHA-G20	GW9.999K-EHA-G20	GW10K-EHA-G20
Storage Temperature (°C)	-40~+70	-40~+70	-40~+70
Decisive Voltage Class (DVC)	Battery: A PV: C AC: C Com: A	Battery: A PV: C AC: C Com: A	Battery: A PV: C AC: C Com: A
Mounting Method	Wall/Floor Mounted	Wall/Floor Mounted	Wall/Floor Mounted
Active Anti-islanding Method	SMS(Slip-mode frequency) +AFD	SMS(Slip-mode frequency) +AFD	SMS(Slip-mode frequency) +AFD
Country of Manufacture	China	China	China
Certification			
Grid Standard	IEC/EN 61000-6-1/-2/-3/-4, IEC/EN 62920, CISPR 11, EN 55011, AS/NZS 61000.6.3/.4, AS 61000.6.4		
Safety Regulation	IEC62109-1/-2, IEC 63037		
EMC	IEC/EN 61000-6-1/-2/-3/-4		

*1: If there's no PV, start-up voltage will be 380V.

*2: When the input voltage is 560V-600V, the inverter will enter standby mode, and the voltage returns to 560V to enter the normal operation state.

*3: Please refer to the user manual for the MPPT Voltage Range at Nominal Power.

*4: If the Back-up port is not used, select an appropriate circuit breaker based on the AC Max. Output Current.

*5: GOODWE ESA series has internal bypass 63A passthrough ability to support whole home backup solution. If the customer don't want to do any breaker upgrade, the main breaker size in SolarGo(or SEMS+) can be set as previous breaker size.

Technical Data	GW3K-BHA-G20	GW3.6K-BHA-G20	GW5K-BHA-G20
Battery Side			
Battery Type	Li-ion	Li-ion	Li-ion
Nominal Voltage (V)	380	380	380
Voltage Range (V)	350~550	350~550	350~550
Start-up Voltage (V)	380	380	380
Number of Battery Inputs	1	1	1
Max. Continuous Charging Current (A)	7.9	9.5	13.2
Max. Continuous Discharging Current (A)	8.7	10.5	14.5
Max. Charging Power (kW)	3	3.6	5
Max. Discharging Power (kW)	3.3	3.96	5.5
Short-time withstand current (A)	980	980	980
AC Side (On-grid)			
Rated Power (kW)	3	3.6	5
Max. Power (kW)	3	3.6	5
Rated Apparent Power from Grid (kVA)	3	3.6	5

Technical Data	GW3K-BHA-G20	GW3.6K-BHA-G20	GW5K-BHA-G20
Rated Apparent Power to Grid (kVA)	3	3.6	5
Max. Apparent Power to Grid (kVA)	3	3.6	5
Max. Apparent Power from Grid (kVA)	6	7.2	10
Nominal Voltage (V)	220/230/240, L/N/PE	220/230/240, L/N/PE	220/230/240, L/N/PE
Voltage Range (V)	170~280	170~280	170~280
Nominal Frequency (Hz)	50/60	50/60	50/60
Frequency Range (Hz)	45~55 / 55~65	45~55 / 55~65	45~55 / 55~65
Rated Current From Grid (A)	13.7 @220V 13.1 @230V 12.5 @240V	16.4 @220V 15.7 @230V 15 @240V	22.8 @220V 21.8 @230V 20.9 @240V
Rated Current to Grid (A)	13.7 @220V 13.1 @230V 12.5 @240V	16.4 @220V 15.7 @230V 15 @240V	22.8 @220V 21.8 @230V 20.9 @240V
Max. Current From Grid (A) ^{*1}	27.3 @220V 26.1 @230V 25 @240V	32.8 @220V 31.4 @230V 30 @240V	45.5 @220V 43.5 @230V 41.7 @240V
Max. Current to Grid (A)	13.7 @220V 13.1 @230V 12.5 @240V	16.4 @220V 15.7 @230V 15 @240V	22.8 @220V 21.8 @230V 20.9 @240V
Max. Output Fault Current (Peak and Duration) (A)	96A@3μs	96A@3μs	96A@3μs

Technical Data	GW3K-BHA-G20	GW3.6K-BHA-G20	GW5K-BHA-G20
Inrush Current (Peak and Duration) (A)	96A@3 μ s	96A@3 μ s	96A@3 μ s
Power Factor	0.8 leading ... 0.8 lagging	0.8 leading ... 0.8 lagging	0.8 leading ... 0.8 lagging
THDi	<3%	<3%	<3%
Maximum Output Overcurrent Protection (A)	96	96	96
Type of Voltage	a.c.	a.c.	a.c.
Back-up Side			
Rated Apparent Power (kVA)	3	3.6	5
Max. Apparent Power (kVA)	Off-grid: 3.0 (6.0, 10s) On-grid: 6	Off-grid: 3.6 (7.2, 10s) On-grid: 7.2	Off-grid: 5.0 (10.0, 10s) On-grid: 10
Nominal Voltage (V)	220/230/240, L/N/PE	220/230/240, L/N/PE	220/230/240, L/N/PE
Nominal Frequency (Hz)	50/60	50/60	50/60
Frequency Range (Hz)	45~55 / 55~65	45~55 / 55~65	45~55 / 55~65
Rated Current (A)	13.7 @220V 13.1 @230V 12.5 @240V	16.4 @220V 15.7 @230V 15 @240V	22.8 @220V 21.8 @230V 20.9 @240V

Technical Data	GW3K-BHA-G20	GW3.6K-BHA-G20	GW5K-BHA-G20
Max. Current (A)* ²	Off-grid: 13.7 @220V 13.1 @230V 12.5 @240V On-grid: 27.3	Off-grid: 6.4 @220V 15.7 @230V 15 @240V On-grid: 32.8	Off-grid: 22.8 @220V 21.8 @230V 20.9 @240V On-grid: 45.5
Max. Fault Current (Peak and Duration) (A)	96A@3μs	96A@3μs	96A@3μs
Inrush Current (Peak and Duration) (A)	96A@3μs	96A@3μs	96A@3μs
Maximum Output Overcurrent Protection (A)	96	96	96
THDv (@Linear Load)	<3%	<3%	<3%
On/Off-grid Switching Time (ms)	<10	<10	<10
Efficiency			
Max. Battery to AC Efficiency	98.0%	98.0%	98.0%
Protection			
Residual Current Monitoring	Integrated	Integrated	Integrated
Battery Reverse Polarity Protection	Integrated	Integrated	Integrated
Anti-islanding Protection	Integrated	Integrated	Integrated

Technical Data	GW3K-BHA-G20	GW3.6K-BHA-G20	GW5K-BHA-G20
AC Overcurrent Protection	Integrated	Integrated	Integrated
AC Short Circuit Protection	Integrated	Integrated	Integrated
AC Overvoltage Protection	Integrated	Integrated	Integrated
AC Surge Protection	Type II	Type II	Type II
Remote Shutdown	Integrated	Integrated	Integrated
General Data			
Operating Temperature Range (°C)	-35~+60 (Derating at +40)	-35~+60 (Derating at +40)	-35~+60 (Derating at +40)
Operating Environment	Outdoor	Outdoor	Outdoor
Relative Humidity	0~95%	0~95%	0~95%
Max. Operating Altitude (m)	4000 (>2000 derating)	4000 (>2000 derating)	4000 (>2000 derating)
Cooling Method	Natural convection	Natural convection	Natural convection
User Interface	LED, WLAN+APP	LED, WLAN+APP	LED, WLAN+APP
Communication with BMS	CAN	CAN	CAN
Communication	RS485, WiFi+LAN+Bluetooth	RS485, WiFi+LAN+Bluetooth	RS485, WiFi+LAN+Bluetooth
Communication Protocols	Modbus-RTU, Modbus-TCP	Modbus-RTU, Modbus-TCP	Modbus-RTU, Modbus-TCP

Technical Data	GW3K-BHA-G20	GW3.6K-BHA-G20	GW5K-BHA-G20
Weight (kg)	16.9	16.9	16.9
Dimension (W×H×D mm)	800*300*270	800*300*270	800*300*270
Noise Emission (dB)	≤30	≤30	≤30
Topology	Non-isolated	Non-isolated	Non-isolated
Power Self-consumption at Night (W)	≤10	≤10	≤10
Ingress Protection Rating	IP66	IP66	IP66
AC Connector	VACONN Terminal	VACONN Terminal	VACONN Terminal
Environmental Category	4K4H	4K4H	4K4H
Pollution Degree	IV (Outside of the inverter)	IV (Outside of the inverter)	IV (Outside of the inverter)
Overvoltage Category	DC II / AC III	DC II / AC III	DC II / AC III
Protective Class	I	I	I
Storage Temperature (°C)	-40~+70	-40~+70	-40~+70
Decisive Voltage Class (DVC)	Battery: A AC: C Com: A	Battery: A AC: C Com: A	Battery: A AC: C Com: A
Mounting Method	Wall/Floor Mounted	Wall/Floor Mounted	Wall/Floor Mounted

Technical Data	GW3K-BHA-G20	GW3.6K-BHA-G20	GW5K-BHA-G20
Active Anti-islanding Method	SMS(Slip-mode frequency) +AFD	SMS(Slip-mode frequency) +AFD	SMS(Slip-mode frequency) +AFD
Country of Manufacture	China	China	China
Certification			
Grid Standard	Please refer to the official website		
Safety Regulation			
EMC			

Technical Data	GW6K-BHA-G20	GW8K-BHA-G20	GW9.999K-BHA-G20
Battery Side			
Battery Type	Li-ion	Li-ion	Li-ion
Nominal Voltage (V)	380	380	380
Voltage Range (V)	350~550	350~550	350~550
Start-up Voltage (V)	380	380	380
Number of Battery Inputs	1	1	1
Max. Continuous Charging Current (A)	15.8	21.1	26.4
Max. Continuous Discharging Current (A)	17.4	23.2	29
Max. Charging Power (kW)	6	8	9.999

Technical Data	GW6K-BHA-G20	GW8K-BHA-G20	GW9.999K-BHA-G20
Max. Discharging Power (kW)	6.6	8.8	11
Short-time withstand current (A)	980	980	980
AC Side (On-grid)			
Rated Power (kW)	6	8	9.999
Max. Power (kW)	6	8	9.999
Rated Apparent Power from Grid (kVA)	6	8	9.999
Rated Apparent Power to Grid (kVA)	6	8	9.999
Max. Apparent Power to Grid (kVA)	6	8	9.999
Max. Apparent Power from Grid (kVA)	12	14.5	14.5
Nominal Voltage (V)	220/230/240, L/N/PE	220/230/240, L/N/PE	220/230/240, L/N/PE
Voltage Range (V)	170~280	170~280	170~280
Nominal Frequency (Hz)	50/60	50/60	50/60
Frequency Range (Hz)	45~55 / 55~65	45~55 / 55~65	45~55 / 55~65
Rated Current From Grid (A)	27.3 @220V 26.1 @230V 25 @240V	36.4 @220V 34.8 @230V 33.4 @240V	45.5 @220V 43.5 @230V 41.7 @240V

Technical Data	GW6K-BHA-G20	GW8K-BHA-G20	GW9.999K-BHA-G20
Rated Current to Grid (A)	27.3 @220V 26.1 @230V 25 @240V	36.4 @220V 34.8 @230V 33.4 @240V	43.5 @220V 43.5 @230V 41.7 @240V
Max. Current From Grid (A)*1	50 @220V 50 @230V 50 @240V	63 @220V 63 @230V 60.5 @240V	63 @220V 63 @230V 60.5 @240V
Max. Current to Grid (A)	27.3 @220V 26.1 @230V 25 @240V	36.4 @220V 34.8 @230V 33.4 @240V	43.5 @220V 43.5 @230V 41.7 @240V
Max. Output Fault Current (Peak and Duration) (A)	96A@3μs	120A@3μs	120A@3μs
Inrush Current (Peak and Duration) (A)	96A@3μs	120A@3μs	120A@3μs
Power Factor	0.8 leading ... 0.8 lagging	0.8 leading ... 0.8 lagging	0.8 leading ... 0.8 lagging
THDi	<3%	<3%	<3%
Maximum Output Overcurrent Protection (A)	96	120	120
Type of Voltage	a.c.	a.c.	a.c.
Back-up Side			
Rated Apparent Power (kVA)	6	8	10
Max. Apparent Power (kVA)	Off-grid: 6.0 (12.0, 10s) On-grid: 12	Off-grid: 8.0 (16.0, 10s) On-grid: 14.5	Off-grid: 10.0 (20.0, 10s) On-grid: 14.5

Technical Data	GW6K-BHA-G20	GW8K-BHA-G20	GW9.999K-BHA-G20
Nominal Voltage (V)	220/230/240, L/N/PE	220/230/240, L/N/PE	220/230/240, L/N/PE
Nominal Frequency (Hz)	50/60	50/60	50/60
Frequency Range (Hz)	45~55 / 55~65	45~55 / 55~65	45~55 / 55~65
Rated Current (A)	27.3 @220V 26.1 @230V 25 @240V	36.4 @220V 34.8 @230V 33.4 @240V	43.5 @220V 43.5 @230V 41.7 @240V
Max. Current (A) ^{*2}	Off-grid: 27.3 @220V 26.1 @230V 25 @240V On-grid: 50	Off-grid: 36.4 @220V 34.8 @230V 33.4 @240V On-grid: 63	Off-grid: 43.5 @220V 43.5 @230V 41.7 @240V On-grid: 63
Max. Fault Current (Peak and Duration) (A)	96A@3μs	120A@3μs	120A@3μs
Inrush Current (Peak and Duration) (A)	96A@3μs	120A@3μs	120A@3μs
Maximum Output Overcurrent Protection (A)	96	120	120
THDv (@Linear Load)	<3%	<3%	<3%
On/Off-grid Switching Time (ms)	<10	<10	<10
Efficiency			

Technical Data	GW6K-BHA-G20	GW8K-BHA-G20	GW9.999K-BHA-G20
Max. Battery to AC Efficiency	98.0%	97.8%	97.8%
Protection			
Residual Current Monitoring	Integrated	Integrated	Integrated
Battery Reverse Polarity Protection	Integrated	Integrated	Integrated
Anti-islanding Protection	Integrated	Integrated	Integrated
AC Overcurrent Protection	Integrated	Integrated	Integrated
AC Short Circuit Protection	Integrated	Integrated	Integrated
AC Overvoltage Protection	Integrated	Integrated	Integrated
AC Surge Protection	Type II	Type II	Type II
Remote Shutdown	Integrated	Integrated	Integrated
General Data			
Operating Temperature Range (°C)	-35~+60 (Derating at +40)	-35~+60 (Derating at +40)	-35~+60 (Derating at +40)
Operating Environment	Outdoor	Outdoor	Outdoor
Relative Humidity	0~95%	0~95%	0~95%
Max. Operating Altitude (m)	4000 (>2000 derating)	4000 (>2000 derating)	4000 (>2000 derating)

Technical Data	GW6K-BHA-G20	GW8K-BHA-G20	GW9.999K-BHA-G20
Cooling Method	Natural convection	Natural convection	Natural convection
User Interface	LED, WLAN+APP	LED, WLAN+APP	LED, WLAN+APP
Communication with BMS	CAN	CAN	CAN
Communication	RS485, WiFi+LAN+Bluetooth	RS485, WiFi+LAN+Bluetooth	RS485, WiFi+LAN+Bluetooth
Communication Protocols	Modbus-RTU, Modbus-TCP	Modbus-RTU, Modbus-TCP	Modbus-RTU, Modbus-TCP
Weight (kg)	16.9	17.7	17.7
Dimension (W×H×D mm)	800*300*270	800*300*270	800*300*270
Noise Emission (dB)	≤30	≤35	≤35
Topology	Non-isolated	Non-isolated	Non-isolated
Power Self-consumption at Night (W)	≤10	≤10	≤10
Ingress Protection Rating	IP66	IP66	IP66
AC Connector	VACONN Terminal	VACONN Terminal	VACONN Terminal
Environmental Category	4K4H	4K4H	4K4H
Pollution Degree	IV (Outside of the inverter)	IV (Outside of the inverter)	IV (Outside of the inverter)

Technical Data	GW6K-BHA-G20	GW8K-BHA-G20	GW9.999K-BHA-G20
Overvoltage Category	DC II / AC III	DC II / AC III	DC II / AC III
Protective Class	I	I	I
Storage Temperature (°C)	-40~+70	-40~+70	-40~+70
Decisive Voltage Class (DVC)	Battery: A AC: C Com: A	Battery: A AC: C Com: A	Battery: A AC: C Com: A
Mounting Method	Wall/Floor Mounted	Wall/Floor Mounted	Wall/Floor Mounted
Active Anti-islanding Method	SMS(Slip-mode frequency) +AFD	SMS(Slip-mode frequency) +AFD	SMS(Slip-mode frequency) +AFD
Country of Manufacture	China	China	China
Certification			
Grid Standard	Please refer to the official website		
Safety Regulation			
EMC			

Technical Data	GW10K-BHA-G20
Battery Side	
Battery Type	Li-ion
Nominal Voltage (V)	380
Voltage Range (V)	350~550
Start-up Voltage (V)	380

Technical Data	GW10K-BHA-G20
Number of Battery Inputs	1
Max. Continuous Charging Current (A)	26.4
Max. Continuous Discharging Current (A)	29
Max. Charging Power (kW)	10
Max. Discharging Power (kW)	11
Short-time withstand current (A)	980
AC Side (On-grid)	
Rated Power (kW)	10
Max. Power (kW)	10
Rated Apparent Power from Grid (kVA)	10
Rated Apparent Power to Grid (kVA)	10
Max. Apparent Power to Grid (kVA)	10
Max. Apparent Power from Grid (kVA)	14.5
Nominal Voltage (V)	220/230/240, L/N/PE
Voltage Range (V)	170~280
Nominal Frequency (Hz)	50/60
Frequency Range (Hz)	45~55 / 55~65
Rated Current From Grid (A)	45.5 @220V 43.5 @230V 41.7 @240V
Rated Current to Grid (A)	43.5 @220V 43.5 @230V 41.7 @240V

Technical Data	GW10K-BHA-G20
Max. Current From Grid (A)* ¹	63 @220V 63 @230V 60.5 @240V
Max. Current to Grid (A)	43.5 @220V 43.5 @230V 41.7 @240V
Max. Output Fault Current (Peak and Duration) (A)	120A@3μs
Inrush Current (Peak and Duration) (A)	120A@3μs
Power Factor	0.8 leading ... 0.8 lagging
THDi	<3%
Maximum Output Overcurrent Protection (A)	120
Type of Voltage	a.c.
Back-up Side	
Rated Apparent Power (kVA)	10
Max. Apparent Power (kVA)	Off-grid: 10.0 (20.0, 10s) On-grid: 14.5
Nominal Voltage (V)	220/230/240, L/N/PE
Nominal Frequency (Hz)	50/60
Frequency Range (Hz)	45~55 / 55~65
Rated Current (A)	43.5 @220V 43.5 @230V 41.7 @240V

Technical Data	GW10K-BHA-G20
Max. Current (A)*2	Off-grid: 43.5 @220V 43.5 @230V 41.7 @240V On-grid: 63
Max. Fault Current (Peak and Duration) (A)	120A@3μs
Inrush Current (Peak and Duration) (A)	120A@3μs
Maximum Output Overcurrent Protection (A)	120
THDv (@Linear Load)	<3%
On/Off-grid Switching Time (ms)	<10
Efficiency	
Max. Battery to AC Efficiency	97.8%
Protection	
Residual Current Monitoring	Integrated
Battery Reverse Polarity Protection	Integrated
Anti-islanding Protection	Integrated
AC Overcurrent Protection	Integrated
AC Short Circuit Protection	Integrated
AC Overvoltage Protection	Integrated
AC Surge Protection	Type II
Remote Shutdown	Integrated
General Data	

Technical Data	GW10K-BHA-G20
Operating Temperature Range (°C)	-35~+60 (Derating at +40)
Operating Environment	Outdoor
Relative Humidity	0~95%
Max. Operating Altitude (m)	4000 (>2000 derating)
Cooling Method	Natural convection
User Interface	LED, WLAN+APP
Communication with BMS	CAN
Communication	RS485, WiFi+LAN+Bluetooth
Communication Protocols	Modbus-RTU, Modbus-TCP
Weight (kg)	17.7
Dimension (W×H×D mm)	800*300*270
Noise Emission (dB)	≤35
Topology	Non-isolated
Power Self-consumption at Night (W)	≤10
Ingress Protection Rating	IP66
AC Connector	VACONN Terminal
Environmental Category	4K4H
Pollution Degree	IV (Outside of the inverter)
Overvoltage Category	DC II / AC III
Protective Class	I
Storage Temperature (°C)	-40~+70

Technical Data	GW10K-BHA-G20
Decisive Voltage Class (DVC)	Battery: A AC: C Com: A
Mounting Method	Wall/Floor Mounted
Active Anti-islanding Method	SMS(Slip-mode frequency) +AFD
Country of Manufacture	China
Certification	
Grid Standard	Please refer to the official website
Safety Regulation	
EMC	

*1: GOODWE ESA series has internal bypass 63A passthrough ability to support whole home backup solution. If the customer don't want to do any breaker upgrade, the max current from grid in SolarGo(or SEMS+) can be set as previous breaker size.

*2: The Max. Output Current in off-grid operation accounts for a three-phase maximum 150% unbalanced capability.

12.2 Battery Technical Data

Technical Data	GW5.1-BAT-D-G20	GW8.3-BAT-D-G20	GW5.1-BAT-D-G21	GW8.3-BAT-D-G21
Rated Energy (kWh)	5.12	8.32	5.12	8.32
Usable Energy (kWh)*1	5	8	5	8
Battery Type	LFP (LiFePO ₄)			
Operating Voltage Range (V) (single phase system)	350~550			

Technical Data	GW5.1-BAT-D-G20	GW8.3-BAT-D-G20	GW5.1-BAT-D-G21	GW8.3-BAT-D-G21
Operating Voltage Range (V) (three phase system)	700~950			
Max. Input Current (System) (A)	12	19	12	19
Max. Output Current (System) (A)	13.2	21	13.2	21
Max. Input Power (System) (kW) ^{*2}	5	8	5	8
Max. Output Power (System) (kW) ^{*2}	5	8	5	8
Peak.Output Power (System) (kW) ^{*2}	7.5 @10s	12 @10s	7.5 @10s	12 @10s
Charging Temperature Range (°C)	-18~55		2~55	
Discharging Temperature Range (°C)	-20~55		-20~55	
Relative Humidity	5-95%			
Max. Operating Altitude (m)	4000			
Noise Emission (dB)	≤29			
Communication	CAN			
Weight (kg)	57.5±1	79±1	57.5±1	79±1
Dimensions (W×H×D mm)	800*326*270			
Optional Function Configuration	heating		/	
Ingress Protection	IP66			

Technical Data		GW5.1-BAT-D-G20	GW8.3-BAT-D-G20	GW5.1-BAT-D-G21	GW8.3-BAT-D-G21
Storage Temperature (°C)		-20 ~55			
Max. Storage time		12 months (-20°C~35°C)			
		6 months (35°C~45°C)			
Scalability		6 pcs			
Mounting Method		Floor stacked / Wall-mounted			
Cycle Life		≥6000 (25±2°C, 0.5C, 90%DOD, 70%EOL)			
Country of Manufacture		China			
Standard and Certification	Safety	IEC62619, IEC60730, EN62477, IEC63056, IEC62040, CE, CEC, VDE2510			
	EMC	CE, RCM			
	Transportation	UN38.3 ADR			

*1: Test conditions, 100% DOD (cell 2.85~3.6V voltage range), 0.2P charge & discharge at 25±2 °C for battery system at the beginning of life. Usable energy is defined by its initial design value. Actual available energy may vary depending on charge/discharge rate, environmental conditions (e.g. temperature), transport and storage factors.

*2: Max. Input Power /Max. Output Power/Peak.Output Power derating will occur related to Temperature and SOC.

12.3 Smart Meter Technical Data

12.3.1 GMK110

Technical Parameters		GMK110	
	Application	Single phase	
Input Data	Voltage	Nominal Voltage (V)	220
		Voltage Range (V)	85~288
		Nominal Voltage Frequency (Hz)	50/60
	Current	CT Ratio	120A/40mA
		CT Quantity	1
Communication		RS485	
Communication Distance (m)		1000	
User Interface		2LED	
Accuracy	Voltage/Current	Class I	
	Active Energy	Class I	
	Reactive Energy	Class II	
Power Consumption (w)		<5	
Mechanical Parameters	Dimension (W×H×D mm)	19*85*67	
	Weight (g)	50	
	Mounting Method	Rail Installation	
Environmental Parameters	Ingress Protection Rating	IP20	
	Operating Temperature Range (°C)	-30~ 60	
	Storage Temperature Range (°C)	-30~ 60	
	Relative Humidity (Non-Condensing)	0~95%	
Max. Operating Altitude (m)		3000	

12.3.2 GM330

Technical Parameters		GM330
Measuring Range	Support Grid Type	Three-phase, split-phase, single-phase
	Voltage Range L-N (Vac)	172~817
	Voltage Range L-L (Vac)	100~472
	Nominal Frequency (Hz)	50/60
	CT Ratio	nA:5A
Communication Method		RS485

Technical Parameters		GM330
Communication Parameters	Communication Distance (m/ft)	1000/3280
Precision Accuracy	Voltage/Current	Class 0.5
	Active Energy	Class 0.5
	Reactive Energy	Class 1
General Data	Dimension (WxHxDmm/in)	72x85x72/2.83x3.35x2.83
	Housing	4 modules
	Weight (g/lb)	240/0.53
	Mounting Method	DIN rail
	User Interface	4 LEDs, Reset Button
	Power Consumption (w)	<5
Environmental Parameters	Ingress Protection Rating	IP20
	Operating Temperature Range (°C/°F)	-30~+70/-22~+158
	Storage Temperature Range (°C/°F)	-30~70/-22~+158
	Relative Humidity (No Condensing)	0~95%
	Max. Operating Altitude (m/ft)	3000/9842
Certification Parameters	Certificate	UL1741/ANSI

12.4 Smart Dongle Technical Data

12.4.1 WiFi/LAN Kit-20

Technical Parameters		WiFi/LAN Kit-20
Output Voltage (V)		5
Power Consumption (W)		<=2
Communication Port		USB
Communication Parameters	Ethernet	10M/100Mbps Self-adaptation
	Wireless	IEEE 802.11 b/g/n @2.4 GHz

Technical Parameters		WiFi/LAN Kit-20
	Bluetooth	Bluetooth V4.2 BR/EDR and Bluetooth LE Standard
Mechanical Parameters	Dimension (W×H×D mm)	48.3*159.5*32.1
	Weight (g)	82
	Ingress Protection Rating	IP65
	Mounting Method	USB Port Plugging and Unplugging
Operating Temperature Range (°C)		-30~+60
Storage Temperature Range (°C)		-40~+70
Relative Humidity		0-95%
Max. Operating Altitude (m)		4000

12.4.2 4G Kit-CN-G20

Product Model	4G Kit-CN-G20
Device Management	
Maximum Supported Number of Inverters	1
Power Parameter	
Input Voltage (V)	5
Power Consumption (W)	<=4
Interface Method	USB
Communication Parameters	
4G/3G/2G	LTE-FDD : B1/B3/B5/B8 LTE-TDD : B34/B39/B40/B41
GNSS Location	/
Bluetooth	Bluetooth V5.0
Mechanical Parameters	
Dimension (W×H×D mm)	48.3*95.5*32.1
Weight (g)	87
Indicator	LED* 2
Mounting Method	Plug and Play (PnP)
SIM Dimension	Micro sim,15mm*12mm
Environment Parameters	
Operating Temperature Range (°C)	-30~+65

Product Model	4G Kit-CN-G20
Storage Temperature (°C)	-40~+70
Relative Humidity	0-100%
IP Grade	IP66
Max. Operating Altitude (m)	4000
Safe Service Life (Year)	5

13 Appendix

13.1 FAQ

13.1.1 How to Conduct Auxiliary Detection for Smart Meters/CT?

Meter detection function, which can detect whether the CT of the meter is connected correctly and the current operation status of the meter and CT.

- Approach 1:

1. Access the detection page through **Home > Settings > Electricity Meter/ CT Auxiliary Detection**.
2. Click "Start Detection" and wait for the detection to complete. Then, view the detection results.

- Approach 2:

1. Access the detection  page through **> [System Setup] > [Quick Setting] > [Meter/CT Assisted Test]**.
2. Click "Start Detection" and wait for the detection to complete. Then, view the detection results.

13.1.2 How to Upgrade the Device Version

Through the firmware information, you can view or upgrade the DSP version, ARM version, BMS version, and smart dongle software version of the inverter. Some smart dongles do not support software version upgrade via SolarGo App, and the actual situation shall prevail.

- **Upgrade prompt:**

When the user opens the APP, an upgrade prompt will pop up on the homepage, and the user can choose whether to upgrade or not. If you choose to upgrade, you can complete the upgrade by following the prompts on the interface.

- **Regular upgrade:**

Access the firmware information viewing interface through "Home" > "Settings"

> "Firmware Information"

Click "Check for Updates". If there is a new version, complete the upgrade according to the prompts on the interface.

- **Forced Upgrade:**

The APP will push upgrade information, and users need to upgrade according to the prompts to continue using the app. You can complete the upgrade by following the prompts on the interface.

Inverter Software Version Upgrade

- To connect USB flash drive for local software upgrading.
- Before upgrading the device using a USB flash drive, please contact the after-sales service center to obtain the software upgrade package and upgrade method.

13.2 Abbreviations

Abbreviation	English description	Chinese Description
Ubatt	Battery Voltage Range	Battery voltage range
Ubatt,r	Nominal Battery Voltage	Nominal battery voltage
Ibatt,max (C/D)	Max. Charging Current Max. Discharging Current	Maximum charge/discharge current
EC,R	Rated Energy	Rated energy
UDCmax	Max.Input Voltage	Max. Input Voltage
UMPP	MPPT Operating Voltage Range	MPPT (Maximum Power Point Tracking)
IDC,max	Max. Input Current per MPPT	Each MPPT Max. Current from Grid
ISC PV	Max. Short Circuit Current per MPPT	Maximum short-circuit current per MPPT
PAC,r	Nominal Output Power	Nominal output power
Sr (to grid)	Nominal Apparent Power Output to Utility Grid	Nominal Apparent Power Output to Utility Grid
Smax (to grid)	Max. Apparent Power Output to Utility Grid	Max. Apparent Power Output to Utility Grid
Sr (from grid)	Nominal Apparent Power from Utility Grid	buy power from the gridRated Apparent Power to Grid

Abbreviation	English description	Chinese Description
Smax (from grid)	Max. Apparent Power from Utility Grid	buy power from the grid Max. Apparent Power to Grid
UAC,r	Nominal Output Voltage	Nominal output voltage
fAC,r	Nominal AC Grid Frequency	Nominal AC Grid Frequency
IAC,max(to grid)	Max. AC Current Output to Utility Grid	Max. AC Current Output to Utility Grid
IAC,max(from grid)	Max. AC Current From Utility Grid	Max. Current from Grid
P.F.	Power Factor	Power Factor
Sr	Back-up Nominal apparent power	Off-grid
Smax	Max. Output Apparent Power (VA) Max. Output Apparent Power without Grid	Max. Apparent Power to Grid
IAC,max	Max. Output Current	Max. Current to Grid
UAC,r	Nominal Output Voltage	Maximum Output
fAC,r	Nominal Output Frequency	Nominal output voltage Frequency
Toperating	Operating Temperature Range	Operating Temperature Range
IDC,max	Max. Input Current	Max. Current from Grid
UDC	Input Voltage	voltage
UDC,r	DC Power Supply	DC input
UAC	Power Supply/AC Power Supply	Voltage Range/AC Input
UAC,r	Power Supply/Input Voltage Range	Voltage Range/AC Input
Toperating	Operating Temperature Range	Operating Temperature Range
Pmax	Max Output Power	Maximum Power
PRF	TX Power	emission Power
PD	Power Consumption	Power consumption
PAC,r	Power Consumption	Power consumption
F (Hz)	Frequency	Frequency
ISC PV	Max. Input Short Circuit Current	Maximum input short-circuit current

Abbreviation	English description	Chinese Description
Udcmin-Udcmax	Range of input Operating Voltage	Operating Voltage range
UAC,rang(L-N)	Power Supply Input Voltage	Adapter input Voltage Range
U _{sys,max}	Max System Voltage	Maximum system voltage
Haltitude,max	Max. Operating Altitude	Max. Operating Altitude height
PF	Power Factor	Power Factor
THDi	Total Harmonic Distortion of Current	current harmonic
THDv	Total Harmonic Distortion of Voltage	voltage harmonic
C&I	Commercial & Industrial	Commercial and Industrial
SEMS	Smart Energy Management System	Smart Energy Management System
MPPT	Maximum Power Point Tracking	Maximum Power point tracking
PID	Potential-Induced Degradation	Potential Induced Degradation (PID)
Voc	Open-Circuit Voltage	open-circuit voltage
Anti PID	Anti-PID	Anti-PID
PID Recovery	PID Recovery	PID Recovery
PLC	Power-line Commucation	Power Line Carrier Communication (PLCC)
Modbus TCP/IP	Modbus Transmission Control / Internet Protocol	Modbus based on TCP/IP layer
Modbus RTU	Modbus Remote Terminal Unit	Modbus based on serial link
SCR	Short-Circuit Ratio	Short-circuit ratio
UPS	Uninterruptable Power Supply	uninterruptible power source
ECO mode	Economical Mode	Economic Mode
TOU	Time of Use	Operating Time
ESS	Energy Stroage System	energy storage system
PCS	Power Conversion System	Power Conversion System
RSD	Rapid shutdown	Rapid Shutdown
EPO	Emergency Power Off	Emergency Poweroff
SPD	Surge Protection Device	Lightning Protection Protection

Abbreviation	English description	Chinese Description
ARC	zero injection/zero export Power Limit / Export Power Limit	Power Limit
DRED	Demand Response Enabling Device	Command response device
RCR	Ripple Control Receiver	-
AFCI	AFCI	AFCI (Arc Fault Circuit Interrupter)
GFCI	Ground Fault Circuit Interrupter	Grounding Failure disconnecter
RCMU	Residual Current Monitoring Unit	Residual Current Monitoring Device (RCM)
FRT	Fault Ride Through	ride-through
HVRT	High Voltage Ride Through	High voltage ride-through
LVRT	Low Voltage Ride Through	Low Voltage ride-through
EMS	Energy Management System	Energy Management System
BMS	Battery Management System	Battery Management System
BMU	Battery Measure Unit	Battery acquisition unit
BCU	Battery Control Unit	Battery Control unit
SOC	State of Charge	State of Charge (SOC) of Battery
SOH	State of Health	Battery health status
SOE	State Of Energy	Battery residual energy
SOP	State Of Power	Battery charging Discharge capability
SOF	State Of Function	Functional status of Battery
SOS	State Of Safety	Safe state
DOD	Depth of discharge	depth of discharge

13.3 Explanation of Terms

- **Overvoltage Category Definition**

- **Category I:** applies to equipment connected to a circuit where measures have been taken to reduce transient overvoltage to a low level.
- **Category II:** applies to fixed downstream equipment. For example, appliances, portable tools and other plug-connected equipment; Voltage category III is used if there are special requirements for the reliability and suitability of such

equipment.

- **Category III:** applies to fixed downstream equipment, including the main distribution board. For example, switchgear and other equipment in an industrial installation
- **Category IV:** applies to the upstream equipment in the power supply of the distribution device, including measuring instruments and upstream over-current protection devices.

• **Definition of Types of Damp Places**

Environmental Parameters	Level		
	3K3	4K2	4K4H
Temperature Range	0~+40°C	-33~+40°C	-33~+40°C
Humidity Range	5% to 85%	5% to 85%	4% to 100%

• **Definition of Environmental Category:**

- **Outdoor Inverter:** The ambient air temperature range is -25 to +60°C, and it is suitable for environments with pollution degree 3.
- **Indoor Type II Inverter:** The ambient air temperature range is -25 to +40°C, and it is suitable for environments with pollution degree 3.
- **Indoor Type I Inverter:** The ambient air temperature range is 0 to +40°C, and it is suitable for environments with pollution degree 2.

• **Definition of Pollution Degree Categories:**

- **Pollution Degree 1:** No pollution or only dry non-conductive pollution.
- **Pollution Degree 2:** In general, there is only non-conductive pollution, but the transient conductive pollution caused by occasional condensation must be taken into account.
- **Pollution Degree 3:** There is conductive pollution, or the non-conductive pollution becomes conductive pollution due to condensation.
- **Pollution Degree 4:** Persistent conductive pollution, such as pollution caused by conductive dust or rain and snow.

13.4 Battery SN Code Meaning



The 11th-14th digits

LXD10DSC0002

Bits 11-14 of the product SN code are the production time code.

The above picture has a production date of 2023-08-08

- The 11th and 12th digits represent the last two digits of the year of manufacture, e.g., 2023 is represented by 23.
- The 13th digit is the month of production, e.g., August is represented by 8; as follows:

Month	1~9	10	11	12
Month	1~9	A	B	C

- The 14th digit is the date of production, e.g., the 8th day is indicated by 8; priority is given to the use of numerical representation, e.g., 1~9 indicates the 1st~9th day, A indicates the 10th day, and so on. The letters I and O are not used to avoid confusion. The details are as follows:

Production Date	1	2	3	4	5	6	7	8	9
Code	1	2	3	4	5	6	7	8	9

Production Date	10	11	12	13	14	15	16	17	18
Code	A	B	C	D	E	F	G	H	J

Production Date	21	22	23	24	25	26	27	28	29
Code	M	N	P	Q	R	S	T	U	V

13.5 Safety Country

No.	Safety Code	No.	Safety Code
Europe			
1	IT-CEI 0-21	43	CZ-C
2	IT-CEI 0-16	44	CZ-D
3	DE LV with PV	45	RO-A
4	DE LV without PV	46	RO-B
5	DE-MV	47	RO-D
6	ES-A	48	GB-G98
7	ES-B	49	GB-G99-A
8	ES-C	50	GB-G99-B
9	ES-D	51	GB-G99-C
10	ES-island	52	GB-G99-D
11	BE	53	NI-G98
12	FR	54	IE-16/25A
13	FR-island-50Hz	55	IE-72A
14	FR-island-60Hz	56	IE-ESB
15	PL-A	57	IE-EirGrid
16	PL-B	58	PT-D
17	PL-C	59	EE
18	PL-D	60	NO
19	NL-16/20A	61	FI-A
20	NL-A	62	FI-B
21	NL-B	63	FI-C
22	NL-C	64	FI-D
23	NL-D	65	UA-A1
24	SE-A	66	UA-A2
25	SE MV	67	EN 50549-1
26	SK-A	68	EN 50549-2
27	SK-B	69	DK-West-B-MVHV
28	SK-C	70	DK-East-B-MVHV
29	HU	71	DK-West-C-MVHV
30	CH	72	DK-East-C-MVHV

No.	Safety Code	No.	Safety Code
31	CY	73	DK-West-D-MVHV
32	GR	74	DK-East-D-MVHV
33	DK-West-A	75	FR-Reunion
34	DK-East-A	76	BE-LV (>30kVA)
35	DK-West-B	77	BE-HV
36	DK-East-B	78	CH-B
37	AT-A	79	NI-G99-A
38	AT-B	80	NI-G99-B
39	BG	81	NI-G99-C
40	CZ-A-09	82	NI-G99-D
41	CZ-B1-09	83	IE-LV
42	CZ-B2-09	84	IE-MV
Globe			
1	60Hz-Default	5	IEC 61727-50Hz
2	50Hz-Default	6	IEC 61727-60Hz
3	127Vac-60Hz-Default	7	Warehouse
4	127Vac-50Hz-Default		
America			
1	Argntina	30	US-ISO-NE-480Vac
2	US-208Vac	31	US-ISO-NE-208Vac-3P
3	US-240Vac	32	US-ISO-NE-220Vac-3P
4	Mexico-220Vac	33	US-ISO-NE-240Vac-3P
5	Mexico-440Vac	34	PR-208Vac
6	US-480Vac	35	PR-240Vac
7	US-208Vac-3P	36	PR-480 Vac
8	US-220Vac-3P	37	PR-208Vac-3P
9	US-240Vac-3P	38	PR-220Vac-3P
10	US-CA-208Vac	39	PR-240Vac-3P
11	US-CA-240Vac	40	Cayman
12	US-CA-480Vac	41	Brazil-220Vac
13	US-CA-208Vac-3P	42	Brazil-208Vac

No.	Safety Code	No.	Safety Code
14	US-CA-220Vac-3P	43	Brazil-230Vac
15	US-CA-240Vac-3P	44	Brazil-240Vac
16	US-HI-208Vac	45	Brazil-254Vac
17	US-HI-240Vac	46	Brazil-127Vac
18	US-HI-480Vac	47	Brazil-ONS
19	US-HI-208Vac-3P	48	Barbados
20	US-HI-220Vac-3P	49	Chile-BT
21	US-HI-240Vac-3P	50	Chile-MT
22	US-Kauai-208Vac	51	Colombia
23	US-Kauai-240Vac	52	Colombia<0.25MW 1P
24	US-Kauai-480Vac	53	Colombia<0.25MW 3P
25	US-Kauai-208Vac-3P	54	IEEE 1547-208Vac
26	US-Kauai-220Vac-3P	55	IEEE 1547-20Vac
27	US-Kauai-240Vac-3P	56	IEEE 1547-240Vac
28	US-ISO-NE-208Vac	57	IEEE 1547-230/400Vac
29	US-ISO-NE-240Vac		
Oceania			
1	Australia-A	4	Newzealand
2	Australia-B	5	Newzealand:2015
3	Australia-C	6	NZ-GreGrid
Asia			
1	China A	25	JP-420Vac-50Hz
2	China B	26	JP-420Vac-60Hz
3	China's high pressure	27	JP-480Vac-50Hz
4	China's highest pressure	28	JP-480Vac-60Hz
5	China Power Station	29	Sri Lanka
6	China 242 Shandong	30	Singapore
7	China 242 Hebei	31	Israel-OG
8	China PCS	32	Israel-LV
9	Taiwan	33	Israel-MV

No.	Safety Code	No.	Safety Code
10	Hongkong	34	Israel-HV
11	China 242 Northeast	35	Vietnam
12	Thailand-MEA	36	Malaysia-LV
13	Thailand-PEA	37	Malaysia-MV
14	Mauritius	38	DEWA-LV
15	Korea	39	DEWA-MV
16	India	40	Saudi Arabia
17	India-CEA	41	JP-690Vac-50Hz
18	Pakistan	42	JP-690Vac-60Hz
19	Philippines	43	Srilanka
20	Philippines-127Vac	44	IEC 61727-127Vac-50Hz
21	JP-50Hz	45	IEC 61727-127Vac-60Hz
22	JP-60Hz	46	JP-550Vac-50Hz
23	JP-440Vac-50Hz	47	JP-550Vac-60Hz
24	JP-440Vac-60Hz	48	India-Higher
Africa			
1	South Africa-LV	4	Ghana
2	South Africa-B-MV	5	Ghana-HV
3	South Africa-C-MV		

13.6 Australia Safety Regulations

For the Australian market, to comply with AS/NZS 4777.2:2020, please select from Australia A, Australia B, Australia C, or New Zealand. Please contact your local electricity grid operator on which Region to select.

Selecting a Region B should then automatically load all region B setpoints for volt-watt, volt-var, underfrequency, overfrequency, etc.

Volt-var response set-point values

Region	Default value	U1	U2	U3	U4
Australia A	Voltage	207V	220V	240V	258V

Region	Default value	U1	U2	U3	U4
	Inverter reactive power level (Q) % of S_{rated}	44 % supplying	0%	0%	60 % absorbing
Australia B	Voltage	205V	220V	235V	255V
	Inverter reactive power level (Q) % of S_{rated}	30 % supplying	0%	0%	40 % absorbing
Australia C	Voltage	215V	230V	240V	255V
	Inverter reactive power level (Q) % of S_{rated}	44 % supplying	0%	0%	60 % absorbing
New Zealand	Voltage	207V	220V	235V	244 V
	Inverter reactive power level (Q) % of S_{rated}	60 % supplying	0%	0%	60 % absorbing
Allowed range	Voltage	180 to 230 V	180 to 230 V	230 to 265 V	230 to 265 V
	Inverter reactive power level (Q) % of S_{rated}	30 to 60 % supplying	0%	0%	30 to 60 % absorbing

NOTE 1: Inverters may operate at a reactive power level with a range up to 100 % supplying or absorbing.

NOTE 2: Australia C parameter set is intended for application in isolated or remote power systems.

Volt-watt response default set-point values

Region	Default value	U3	U4
Australia A	Voltage	253V	260V

Region	Default value	U3	U4
	Inverter maximum active power output level (P) % of S_{rated}	100%	20%
Australia B	Voltage	250V	260V
	Inverter maximum active power output level (P) % of S_{rated}	100%	20%
Australia C	Voltage	253V	260V
	Inverter maximum active power output level (P) % of S_{rated}	100%	20%
New Zealand	Voltage	242 V	250V
	Inverter maximum active power output level (P) % of S_{rated}	100%	20%
Allowed range	Voltage	235 to 255 V	240 to 265 V
	Inverter maximum active power output level (P) % of S_{rated}	100%	20%

NOTE: Australia C parameter set is intended for application in isolated or remote power systems.

Passive anti-islanding voltage limit values

Protective function	Protective function limit	Trip delay time	Maximum disconnection time
Undervoltage 2 (V <<)	70 V	1 s	2 s
Undervoltage 1 (V <)	180 V	10 s	11 s
Overvoltage 1 (V >)	265 V	1 s	2 s

Protective function	Protective function limit	Trip delay time	Maximum disconnection time
Overvoltage 2 (V > >)	275V	-	0.2 s

Upper connection and reconnection frequency (f_{URF})

Region	f_{URF}
Australia A	50.15 Hz
Australia B	50.15 Hz
Australia C	50.50 Hz
New Zealand	50.15 Hz

Setting steps:

Step 1: Set the safety code to Australia A/B/C/New Zealand on Quick Settings page based on actual needs.

Step 2: Set the frequency parameters accordingly.

Grid Code (Safety Code) Save

- Europe **Australia** ▾
- Oceania Australia A
- America Australia A_1
- Asia Australia B
- Africa Australia C
- Others Australia D
- New Zealand >
- Others >

Connection Parameters

Ramp Up:

Upper Voltage 110.4 110.4 ✓
Range[80,140]%/Vn

Lower Voltage 85.2 85.2 ✓
Range[15,100]%/Vn

Upper Frequency 50.15 50.15 ✓
Range[50,65]Hz

Lower Frequency 47.50 47.50 ✓
Range[45,60]Hz

Observation Time 60 60 ✓
Range[30,30000]s

Soft Ramp Up Gradient

Soft Ramp Up Gradient 16.7 16.7 ✓
Range[0,6000]%/Pr/min

Reconnection:

Upper Voltage 110.4 110.4 ✓
Range[80,140]%/Vn

Lower Voltage 85.2 85.2 ✓
Range[15,100]%/Vn

Upper Frequency 50.15 50.15 ✓
Range[50,65]Hz

Lower Frequency 47.50 47.50 ✓
Range[45,60]Hz

Observation Time 60 60 ✓
Range[30,30000]s

Reconnection Gradient

Reconnection Gradient 16.7 16.7 ✓
Range[0,6000]%/Pr/min

SLG00CON0144

Grid Code (Safety Code) Save

- Europe **Australia** ▾
- Oceania Australia A
- America Australia A_1
- Asia Australia B
- Africa Australia C
- Others Australia D
- New Zealand >
- Others >

Connection Parameters

Ramp Up:

Upper Voltage 110.4 110.4 ✓
Range[80,140]%/Vn

Lower Voltage 85.2 85.2 ✓
Range[15,100]%/Vn

Upper Frequency 50.15 50.15 ✓
Range[50,65]Hz

Lower Frequency 47.50 47.50 ✓
Range[45,60]Hz

Observation Time 60 60 ✓
Range[30,30000]s

Soft Ramp Up Gradient

Soft Ramp Up Gradient 16.7 16.7 ✓
Range[0,6000]%/Pr/min

Reconnection:

Upper Voltage 110.4 110.4 ✓
Range[80,140]%/Vn

Lower Voltage 85.2 85.2 ✓
Range[15,100]%/Vn

Upper Frequency 50.15 50.15 ✓
Range[50,65]Hz

Lower Frequency 47.50 47.50 ✓
Range[45,60]Hz

Observation Time 60 60 ✓
Range[30,30000]s

Reconnection Gradient

Reconnection Gradient 16.7 16.7 ✓
Range[0,6000]%/Pr/min

SLG00CON0146

Grid Code (Safety Code) Save

- Europe **Australia** ▾
- Oceania Australia A ○
- America Australia A_1 ○
- Asia Australia B ○
- Africa Australia C ✓
- Others Australia D ○
- New Zealand >
- Others >

Connection Parameters

Ramp Up:

Upper Voltage 110.4 110.4 ✓
Range(80,140)%Vn

Lower Voltage 85.2 85.2 ✓
Range(15,100)%Vn

Upper Frequency 50.50 50.50 ✓
Range(50,60)Hz

Lower Frequency 47.50 47.50 ✓
Range(45,60)Hz

Observation Time 60 60 ✓
Range(30,30000)s

Soft Ramp Up Gradient

Soft Ramp Up Gradient 16.7 16.7 ✓
Range(0,6000)%P/min

Reconnection:

Upper Voltage 110.4 110.4 ✓
Range(80,140)%Vn

Lower Voltage 85.2 85.2 ✓
Range(15,100)%Vn

Upper Frequency 50.50 50.50 ✓
Range(50,60)Hz

Lower Frequency 47.50 47.50 ✓
Range(45,60)Hz

Observation Time 60 60 ✓
Range(30,30000)s

Reconnection Gradient

Reconnection Gradient 16.7 16.7 ✓
Range(0,6000)%P/min

SLG00CON0145

Contact Information

GoodWe Technologies Co., Ltd.
No. 90 Zijin Road, High-tech Zone, Suzhou, China
400-998-1212
www.goodwe.com
service@goodwe.com